

Preface

Thank you for purchasing EM500 series inverter.

Document No.: 31010076

Issue Date: 2018-07

Version: 103

EM500 inverter is an open-loop vector control inverter that supports: 3-phase AC induction motor and permanent magnet synchronous motor; multiple internationally leading drive control technologies, including improved vectored VF control technology (VVF) and sensorless vector control technology (SVC); speed and torque control; I/O expansion card, communication bus expansion card and special function expansion card.

EM500 dedicates to any application, so it can be applied to nearly all open-loop control applications, for example fan, water pump (water supply under constant pressure), air compressor, winding and unwinding function, and direct wire-drawing machine. For high-precision closed loop application, please select EM600.

Main features:

- Built-in DC reactor starting from 11kW, reducing input current distortion, improving power factor and enhancing reliability of the product;
- High torque control precision: SVC/±8% rated torque;
- Wide speed regulation range and high control precision: VF/1:50, SVC/1:200 and ±0.2% rated speed;
- Loading capacity at low frequency: VF/1Hz/150% and SVC/0.25Hz/150%;
- Multiple types of guarantees: Overvoltage stall, rapid current limit, overload protection, overheating protection, off-load protection, overspeed protection, etc.;
- Support I/O expansion: 4 numeric inputs, 1 numeric output, and one -10V - 10V voltage input;
- Support communication bus expansion and realize various industrial networking: 485 bus, Profibus-DP network, CANopen network and DeviceNet network;
- Support special function expansion: constant pressure water supply and so on.

Please read this manual carefully before using EM500 and keep it properly.

Before connecting inverter and a motor for the first time, please select proper motor type (induction motor or synchronous motor) and configure motor nameplate parameters including rated power, rated voltage, rated current, rated frequency, rated rotation speed, motor connection and rated power factor.

Since SINEE is committed to the development and improvement of products and product documents, this manual will be updated without notice.

Latest updates and additional information are available at www.sineedrive.com.

Safety Information

In this manual, there are two types of safety information.



Danger: The label indicates that a failure to follow instructions can result in serious injury or even death.



Caution: The label indicates that a failure to follow instructions can result in moderate or slight injury and device damage.

Please read this chapter carefully before system installation, debugging and maintenance and always follow the safety precautions below during operation. SINEE will not undertake any damage or loss caused by a failure to follow the instructions.

Safety Precautions

Before Installation:



Danger

1. Do not install inverter if its package is wetted or any its component is missing or broken.
2. Do not install inverter if the label information on its package is not identical to that on inverter.



Caution

1. Be careful when carrying or transporting inverter so as to avoid damage!
2. Do not use inverter if it is damaged or any component is missing so as to avoid injury!
3. Do not touch the parts of control system with bare hands so as to avoid ESD!

During Installation:



Danger

1. Installation base shall be metal or other non-flammable material so as to prevent fire risk.
2. Do not unscrew fixing bolts, especially bolts with red mark.

 **Caution**

1. Ensure that no cable strips or screws are dropped into inverter so as to avoid damage to inverter.
2. Install inverter at a place with less vibration and no direct sunlight.
3. Consider the installation space for cooling purpose when inverter is installed in a closed cabinet or space.

Wiring:

 **Danger**

- Wiring must be performed by authorized and qualified personnel so as to avoid unexpected accidents.
- A circuit breaker must be installed between inverter and the mains so as to prevent fire risk.
- Ensure that power is off before wiring, and ground inverter in accordance with the applicable wiring standard so as to avoid electric shock.
- Grounding terminal must be grounded reliably so as to avoid electric shock and fire risk.

 **Danger**

- Never connect input power supply cable to output terminals U, V or W of inverter. Pay attention to terminal symbols and connect to the terminals correctly so as to prevent risks of damaging inverter.
- Be sure that wiring meets EMC requirements and local safety standards. Cable should be in recommended sizes so as to prevent accident risk.
- Do not connect braking resistor to DC bus terminals + and – so as to prevent fire risk.
- Tighten terminals with a screwdriver of specified torque so as to prevent fire risk.
- Do not connect a phase-shifting capacitor or an LC/RC noise filter to output circuits.
- Do not connect a solenoid switch or an electromagnetic contactor to output circuits.
- Otherwise, it will trigger the action of the overcurrent protection circuit or even damage the internal parts of inverter.
- Do not disconnect internal cable of inverter, or else this can possibly damage the internal parts of inverter.

 **Caution**

1. Ensure the distribution lines accord to EMC requirements and the local area's safety standards. The using wire size refers to the preferred recommendation. Otherwise, an accident may occur!

2. Never connect the braking resistor directly between the DC bus and the terminals. Otherwise cause a fire!
3. Tighten the terminal with the specified torque screwdriver, otherwise there is the danger of fire.
4. Do not connect the phase-shift capacitor LC / RC noise filter to the output circuit
5. Do not connect the electromagnetic switch or electromagnetic contactor to the output circuit. Otherwise, the inverter over-current protection circuit is activated when severe, can cause damage to the inverter.
6. Do not disassemble the connecting cable inside the inverter. Otherwise, the inverter may be damaged.

Before Power-on:



Verify that input voltage is identical to the rated voltage of inverter, input terminals R, S and T and output terminals U, V or W are correctly connected, there are no short circuit phenomena for the wiring of inverter and its peripheral circuits, and all wires are in good connection. Otherwise, this may result in inverter damage.

Never perform voltage withstanding test on inverter, because it has been done at the factory. Otherwise, this may result in accident.



The front cover of inverter must be closed before inverter is powered on. Otherwise, it may result in an electric shock.

The wiring of all peripherals must be conducted in accordance with the guidance of this manual. Otherwise, it may result in an electric hazard.

After Power-on:



1. Do not touch inverter or its peripheral circuits with wet hands to avoid the electric shock.
2. If the indicator is off or the keypad does not display any information after power-on, please cut off the power supply immediately. Never touch any terminal of R, S or T of inverter or the connecting terminals with hands or a screw driver, or else an electric shock accident may occur. Contact our customer service personnel immediately after cutting off the

power.

3. After being powered on, inverter will automatically check the safety of the external strong circuit automatically. Therefore, do not touch wiring terminal U, V or W of inverter or the wiring terminal of the motor with bare hands, otherwise it will result in electric shock.

 **Caution**

If you need to check parameter settings, be careful of personal safety when the motor is running so as to avoid accidents.

Do not change default parameter setting without approval to avoid damage.

During Operation:

 **Danger**

Never touch cooling fan, heat sink or discharge resistor with bare hands for checking temperature, which may result in burning!

Only qualified technicians are allowed to detect signal during operation so as to prevent personal injury or device damage.

 **Caution**

Prevent any foreign items from being dropped into the device during operation, so as to avoid damage to the device.

Do not control the start/stop of inverter by ON/OFF of the contactor so as to avoid damage to the device.

Maintenance:

 **Danger**

Maintain and inspect the device only after inverter is powered off for at least 10 minutes to avoid electric shock.

Maintain and inspect inverter only after its main circuit is powered off and CHARGE indicator is off. Otherwise, the residual electric charge of capacitor may result in personal injury.

Maintenance and inspection can be performed by well-trained technicians only, so as to avoid personal injury or device damage.

Parameter setting is required if inverter has been replaced. Plug-in & plug-out should be

performed after power-off.

For synchronous motor, it will generate power when in rotation, please wait for at least 10 minutes after it stops rotating, and then disconnect the motor from the inverter, otherwise there is risk of electric shock.

Attentions

Motor Insulation Inspection

Motor insulation inspection shall be performed before using a motor for the first time or left unused for some time or during routine inspection, in order to avoid damaging inverter due to failure of insulation performance of motor winding. Make sure to disconnect motor cable from inverter during inspection; 500V megohmmeter is recommended. The obtained insulation resistance from test shall not be lower than 5MΩ.

Motor Thermal Protection

If the selected motor does not match with inverter in rated capacity, especially when its rated power is lower than that of inverter, be sure to adjust motor protection parameters of inverter or install a thermal relay in front of the motor to protect the motor.

Operation at Power frequency

Output frequency of inverter ranges from 0.00 Hz to 600.00 Hz. To use inverter at over 50.00 Hz, please consider the bearing capacity of mechanical device.

Motor Heat and Noise

Since output voltage of inverter presents a PWM waveform along with some harmonic waves, the temperature rise, noise and vibration of motor would increase a little in comparison with the running under power frequency.

Varistor or Power Factor Improvement Capacitor on Inverter Output

Inverter outputs PWM wave. Do not use inverter, if a power factor improvement capacitor or a lightning varistor is on output side, which may easily result in transient overcurrent of inverter, or even damage inverter.

Beyond Rated Voltage

Do not use EM500 inverter outside the operating voltage range specified in this manual, which may easily damage its internal parts. If you have to do so, install a voltage rise or reduction device for transformation.

Surge Protection

A surge protection device is installed in inverter to prevent it from induction lightning stroke on a certain degree. Additional protection devices are required in front of inverter in the places where thunder and lightning occur frequently.

Altitude and Derating

When inverter is used in an area at an altitude of over 1,000m, the cooling effect will degrade, so it must be derated. For details, please consult SINEE.

Attentions at Inverter Scrapping

Burning the electrolytic capacitors of the mains and PCB may result in explosion and burning plastic parts may generate toxic gas. Please handle them as industrial wastes when inverter is scrapped.

CONTENTS

PREFACE	1
SAFETY PRECAUTIONS	2
ATTENTIONS	6
1. OVERVIEW	13
1.1 EM500 MODEL LIST AND TECHNICAL SPECIFICATIONS	13
1.2 EM500 OPERATION STATUS	16
1.3 DESCRIPTION OF PARTS OF EM500 INVERTER	21
2. INSTALLATION.....	23
2.1 PRODUCT VERIFICATION	23
2.2 OVERALL AND INSTALLATION DIMENSIONS	24
2.3 CONSIDERATIONS FOR INSTALLATION SITE	28
2.4 INSTALLATION DIRECTION AND SPACE	29
2.5 ASSEMBLY AND DISASSEMBLY OF KEYPAD	30
2.6 FLUSH MOUNTING.....	31
3. WIRING.....	35
3.1 CONNECTION TO PERIPHERALS	35
3.2 WIRING MAIN CIRCUIT TERMINALS.....	36
3.3 WIRING CONTROL CIRCUIT TERMINALS.....	47
3.4 EXTENDING KEYPAD WIRE.....	58
3.5 WIRING VERIFICATION	58
4. KEYPAD OPERATION	59
4.1 KEYPAD FUNCTION	59
4.2 LED KEYPAD OPERATION MODE.....	61
4.3 FAULT MONITORING	67
4.4 OPERATION MONITORING	68

4.5 PARAMETER COPY	68
4.6 FUNCTION OF M.K.	69
4.7 RUN/STOP	69
5. TRIAL OPERATION	70
5.1 TRIAL OPERATION PROCEDURE.....	70
5.2 ATTENTIONS FOR TRIAL OPERATION.....	72
6. FUNCTION CODE TABLE.....	74
6.1 PARAMETER DESCRIPTION	74
6.2 FUNCTION PARAMETER TABLE.....	75
7. PARAMETER DESCRIPTION.....	151
7.1 F00 GROUP: GENERAL PARAMETER	151
7.2 F01 GROUP: MOTOR 1 PARAMETER.....	171
7.3 F02 GROUP: INPUT TERMINAL PARAMETER	176
7.4 F03 GROUP: OUTPUT TERMINAL FUNCTION PARAMETER.....	192
7.5 F04 GROUP: START/STOP CONTROL PARAMETER	204
7.6 F05 GROUP: VF CONTROL PARAMETER	211
7.7 F06 GROUP: VECTOR CONTROL PARAMETER.....	217
7.8 F07 GROUP: FAULT PROTECTION PARAMETER.....	224
7.9 F08 GROUP: PRESET SPEED AND SIMPLE PLC PARAMETER.....	232
7.10 F09 GROUP: PID FUNCTION PARAMETER	240
7.11 F10 GROUP: COMMUNICATION FUNCTION PARAMETER	251
7.12 F11 GROUP: USER-DEFINED PARAMETER	261
7.13 F12 GROUP: KEYPAD AND DISPLAY PARAMETER.....	263
7.14 F13 GROUP: TORQUE CONTROL PARAMETER	273
7.15 F14 GROUP: MOTOR 2 PARAMETER	278
7.16 F15 GROUP: AUXILIARY FUNCTION	279
7.17 F16 GROUP: USER DEFINED FUNCTION PARAMETER.....	292
7.18 F17 GROUP: VIRTUAL I/O FUNCTION PARAMETER	299

7.19 F18 GROUP: MONITORING PARAMETER.....	303
7.20 F19 GROUP: FAULT RECORD PARAMETER	307
7.21 F25 APPLICATION OF WATER SUPPLY BASIC GROUP.....	310
7.22 F26 APPLICATION OF WATER SUPPLY ADVANCED GROUP.....	320
7.23 F27 WINDING ROLLING APPLICATION	323
7.24 F28 AIR COMPRESSOR APPLICATION.....	337
8. MOTOR PARAMETER AUTOTUNING.....	352
8.1 MOTOR PARAMETER AUTOTUNING	352
8.2 PRECAUTIONS BEFORE AUTOTUNING	352
8.3 STEPS OF AUTOTUNING.....	353
9. TROUBLESHOOTING.....	355
9.1 FAULTS.....	355
9.2 WARNING ANALYSIS.....	363
9.3 FAULT ANALYSIS	365
10. MAINTENANCE AND INSPECTION	369
10.1 ROUTINE MAINTENANCE AND INSPECTION OF INVERTER	369
10.2 WARRANTY INSTRUCTION FOR INVERTER.....	371
11. OPTIONS.....	372
11.1 BRAKING RESISTOR	372
11.2 BRAKING UNIT	373
11.3 OPTIONS OF CABLE	373
11.4 OPTION CARD	374
11.5 BASE.....	375
11.6 UPPER MOUNTING HOLE	378
11.7 COPPER ROW FOR INCOMING AND OUTGOING CABLE SWITCHOVER	379
12. MODBUS COMMUNICATION PROTOCOL	381
12.1 APPLICATION SCOPE	381

12.2 PHYSICAL INTERFACE	381
12.3 PROTOCOL FORMAT	382
12.4 PROTOCOL DESCRIPTION	404
12.5 EXAMPLE	406
13. CANSINEE COMMUNICATION PROTOCOL	411
13.1 APPLICATION SCOPE	411
13.2 PHYSICAL INTERFACES	411
13.3 PROTOCOL FORMAT	412
13.4 BROADCAST MESSAGES	420
13.5 ABNORMAL INFORMATION RESPONSE	420
13.6 ILLUSTRATE	422
APPENDIX I. MULTI-FUNCTIONAL IO EXPANSION CARD	
(EC-IO-A1)	427
I.1 GENERAL	427
I.2 INSTALLATION INSTRUCTIONS	427
I.3 EXPANSION TERMINAL FUNCTION	428
APPENDIX II MULTI-FUNCTIONAL IO EXPANSION CARD 3	
(EC-IO-A3)	430
II.1 GENERAL	430
II.2 INSTALLATION INSTRUCTIONS	430
II.3 EXPANSION TERMINAL FUNCTION	431
APPENDIX III PROFIBUS-DP EXPANSION CARD (EC-CM-P1)..	432
III.1 GENERAL	432
III.2 INSTALLATION INSTRUCTIONS	432
III.3 EXPANSION TERMINAL FUNCTION	433
APPENDIX IV CANOPEN EXPANSION CARD (EC-CM-C1)	435
IV.1 GENERAL	435

IV.2 INSTALLATION INSTRUCTIONS	435
IV.3 EXPANSION TERMINAL FUNCTION	436
APPENDIX V DEVICENET EXPANSION CARD (EC-CM-D1).....	438
V.1 GENERAL	438
V.2 INSTALLATION INSTRUCTIONS	438
V.3 EXPANSION TERMINAL FUNCTION.....	439
APPENDIX VI AIR COMPRESSOR EXPANSION CARD	
(EC-CM-D1)	442
VI.1 GENERAL	442
VI.2 INSTALLATION INSTRUCTIONS	442
VI.3 EXPANSION TERMINAL FUNCTION	443
APPENDIX VII CLOCK EXPANSION CARD (EC-TM-A1).....	445
VII.1 GENERAL	445
VII.2 INSTALLATION INSTRUCTIONS	445
VII.3 EXPANSION TERMINAL FUNCTION.....	446
APPENDIX VIII APPENDIX VII. PHASE SEQUENCE EXPANSION	
CARD (EC-PSP-A1)	447
VIII.1 GENERAL	447
VIII.2 INSTALLATION INSTRUCTIONS	447
VIII.3 EXPANSION TERMINAL FUNCTION.....	448

1. Overview

1.1 EM500 Model List and Technical Specifications

- Rated voltage: 3-phase, 380 - 415VAC, 3-phase or single-phase 220 – 230VAC;
- Applicable motor: 3-phase AC induction motor and permanent magnet synchronous motor, power range: 0.75 - 630kW;
- Maximum output voltage is identical to input voltage.

EM500 model and rated output current are shown in Table 1–1.

Table 1-1 EM500 Model List

Rated Voltage	Model	Motor Power (kW)	Rated Output Current (A)
3-phase, 380 - 415V	EM500-0R7G/1R5P-3B	0.75/1.5	2.5/4.2
	EM500-1R5G/2R2P-3B	1.5/2.2	4.2/5.6
	EM500-2R2G/3R0P-3B	2.2/3.0	5.6/7.2
	EM500-4R0G/5R5P-3B	4.0/5.5	9.4/12
	EM500-5R5G/7R5P-3B	5.5/7.5	13/17
	EM500-7R5G/9R0P-3B	7.5/9	17/20
	EM500-011G/015P-3B	11/15	25/32
	EM500-015G/018P-3B	15/18.5	32/38
	EM500-018G/022P-3B	18.5/22	38/44
	EM500-022G/030P-3/3B	22/30	45/59
	EM500-030G/037P-3/3B	30/37	60/73
	EM500-037G/045P-3/3B	37/45	75/87
	EM500-045G/055P-3/3B	45/55	90/106
	EM500-055G/075P-3/3B	55/75	110/145
	EM500-075G/090P-3/3B	75/90	150/169
	EM500-090G/110P-3	90/110	176/208
	EM500-110G/132P-3	110/132	210/248
	EM500-132G/160P-3	132/160	253/298
	EM500-160G/185P-3	160/185	304/350
	EM500-185G/200P-3	185/200	357/372
	EM500-200G/220P-3	200/220	380/410
	EM500-220G/250P-3	220/250	426/456
EM500-250G/280P-3	250/280	465/510	
EM500-280G/315P-3	280/315	520/573	
EM500-315G/355P-3	315/355	585/640	
EM500-355G/400P-3	355/400	650/715	

EM500 Open-Loop Vector Control Inverter User Manual

	EM500-400G/450P-3	400/450	725/810
	EM500-450G/500P-3	450/500	820/900
	EM500-500G/560P-3	500/560	900/1010
	EM500-560G/630P-3	560/630	1010/1140
3-phase, 220~230V	EM500-0R7G/1R5P-2B	0.75/1.5	4.8/8.0
	EM500-1R5G/2R2P-2B	1.5/2.2	8.0/10.0
	EM500-2R2G/3R0P-2B	2.2/3.0	10.0/13.0
Single-phase 220~230V	EM500-0R7G/1R5P-1B	0.75/1.5	4.8/8.0
	EM500-1R5G/2R2P-1B	1.5/2.2	8.0/10.0
	EM500-2R2G/3R0P-1B	2.2/3.0	10.0/13.0

★ the difference between inverter and motor shall not be more than two power ratings.

Please try to select a motor that matches with inverter in rated current.

EM500 technical specifications are shown in Table 1-2.

Table 1-2 EM500 Technical Specifications

Items		Specifications
Input	Rate Voltage Range	3-phase 380V-20% - 415V+20%, 3-phase or single-phase 220 - 230VAC; 50 - 60 Hz \pm 5%, voltage unbalance <3%
Output	Maximum Output Voltage	Maximum output voltage is identical to input voltage.
	Rated Output Current	100% non-stop rated current output
	Maximum Overload Current	Model G: 150% rated current for 60s, 180% rated current for 10s and 200% rated current for 2s Model P: 120% rated current for 60s, 150% rated current for 10s and 180% rated current for 2s
Basic Control Functions	Control Mode	V/F(VVF) and SVC
	Input Mode	Frequency (speed) input and torque input
	Start/Stop Control Mode	Keypad, control terminals (2-wire sequence, 3-wire sequence) and communication
	Frequency Control Range	0.00 - 600.00 Hz /0.0 - 3000Hz
	Input Frequency Resolution	Numeric input: 0.01 Hz/ 0.1Hz, analog input: 0.1% of maximum frequency
	Governor Deflection	1: 50 (VVF), 1:200 (SVC)
	Speed Control Accuracy	\pm 0.2% rated synchronous speed
	Acceleration/Deceleration Time	0.01-600.00 seconds/0.1 - 6000.0 seconds/1 - 60000 seconds
	V/F Features	Rated output voltage: 20% - 100% adjustable; frequency base: 1 Hz - 600 Hz/3000Hz adjustable

	Torque Boost	Fixed torque boost curve, customer defined V/F curve scaling
	Start Torque	150%/ 1 Hz (VVF), 150%/ 0.25 Hz (SVC)
	Torque Control Accuracy	±8% rated torque (SVC)
	AVR	Output voltage remains unchanged basically and input voltage varies when AVR is active
	Automatic Current Limit	Automatically limit output current to avoid frequently overcurrent trip.
	DC Brake	Brake frequency: 0.01 - Maximum frequency, brake time: 0 - 30S Brake current: 0% - 100% rated current
	Signal Input Source	Communication, preset speed, analog, high-speed impulse
Function of Input and Output	Reference Power Supply	10V/20mA
	Terminal Control Power Supply	24V/200mA
	Numeric Input Terminal	7 (standard X1 - X7) + 4 (expansion card X8 - X11) numeric multi-functional input terminals: X7 can be selected as high-speed impulse input terminal (F02.06=35/38/40); X1 - X6 and X8 - X11 (10 in total) can be used as common digital input terminals.
	Analog Input Terminal	3 (standard AI1 - AI3) + 1 (expansion card AI4) analog input terminals: 1 (AI1) voltage source 0 - 10 input; 2 (AI2/AI3) voltage source 0 - 10V inputs or current source 0 - 20mA input; 1 (AI4) voltage source -10V - 10V input
	Numeric Output Terminal	2 (standard Y1/Y2) + 1 (expansion card Y3) OC multi-functional outputs and 2 (R1: EA/EB/EC and R2: RA/RB/RC) relay multi-functional outputs. Maximum output current of OC: 50mA; relay contact capacity: 250VAC/3A or 30VDC/1A. When the relay works, EA-EC and RA-RC are on, but EB-EC and RB-RC are off.
	Analog Output Terminal	M1 is with output 0 - 10V only. M2 is with output 0 - 10V or 0 - 20 mA.
Keypad Display	LED	LED displays relevant information about inverter.
	Parameter Copy	Upload and download parameter setting information of inverter to realize rapid copy.
Protection	Protection	Short circuit, overcurrent, overvoltage, undervoltage, phase loss, overload, overheating, overspeed, offload, external fault, etc.

Working Condition	Installation Site	To be installed indoor with an altitude less than 1,000 meters, free from dust, corrosive gas and direct sunlight.
	Ambient Temperature	-10°C - +40°C, 20% - 90%RH (no condensation)
	Vibration	< 0.5g
	Storage Temperature	-25°C ~ +65°C
	Installation Method	Wall mounting, floor mounting (electrical cabinet) and flush mounting
Protection Degree	IP20/IP21 (450kW and above)	
Cooling Method	Forced air cooling	

1.2 EM500 Operation Status

1.2.1 Operating Status of Inverter

EM500 inverter operating status: Parameter setting status, normal running status, JOG running status, autotuning status, stop status, JOG stop status and fault status.

- **Parameter setting status:** After it is powered on and initialized and is standby without a fault or a start-up command, inverter has no output.
- **Normal running status:** Having received an active start command through keypad, control terminal or communication, inverter drives motor as per the setting input.
- **JOG running status:** Drives motor at JOG input speed through setting of keypad, external terminal or communication.
- **Autotuning status:** Set through keypad to autotune the parameters of motor in stationary or rotational autotuning.
- **Stop status:** When a running command is inactive, output frequency drops to zero as per set deceleration time.
- **JOG stop status:** When JOG running command is inactive, output frequency drops to zero as per JOG deceleration time.
- **Fault status:** Status of inverter under protection, and all kinds of faults and failures.

1.2.2 Control Modes of Inverter

Control modes of inverter refer to what kind of method is adopted to drive motor at desired speed or torque. These modes include:

- VVF (Vector decoupling based VF control): The steady performance is the same as that in SVC. Suitable for occasions of low speed change and low speed stability accuracy and meet the needs of most AC motor drives.
- SVC (Sensorless Vector Control): Advanced speed estimate algorithm, no need for encoder, open loop vector control and high control accuracy.

1.2.3 Setting Modes of Inverter

Setting mode of inverter refers to what kind of physical quantity is taken as the control object when inverter drives motor.

- Speed setting mode: Motor speed is taken as the control object;

This mode can be realized by numeric setting, analog input setting, high-speed pulse input setting, communication setting, digital potentiometer setting, process PID, simple PLC or preset speed, individually or jointly. In Figure 1-1 to Figure 1-4, various input

modes under the speed setting mode of EM500 are described:

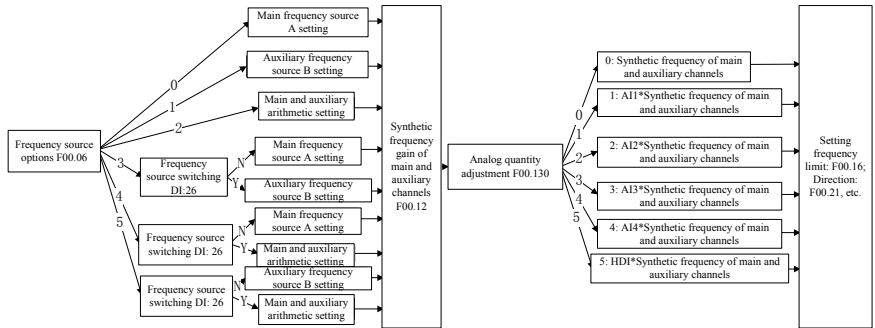

Figure 1-1 Speed Input Mode

As indicated in Figure 1-1, there are mainly three speed setting modes of EM500, respectively main frequency source A setting (referred to as “Main A” for short), auxiliary frequency source B setting (referred to as “Auxiliary B” for short) and main & auxiliary arithmetic setting. The speed setting mode is finalized by simple regulation and

limit (upper limit frequency limit, maximum frequency limit, direction limit and frequency hopping limit). The setting descriptions are given in Figure 1-2 to Figure 1-4.

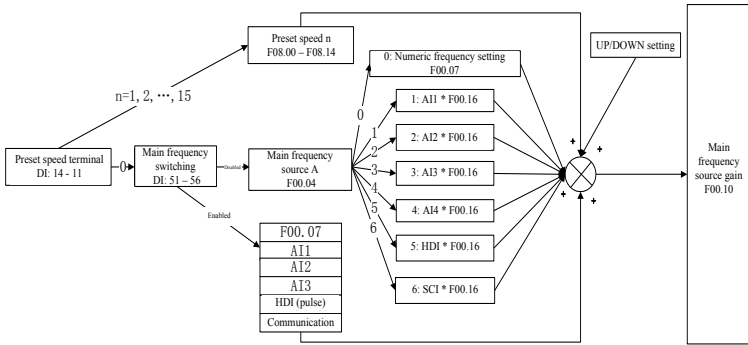

Figure 1-2 Main Frequency Source A Setting

As indicated in Figure 1-2, when setting main frequency source A, user needs to consider settings and status of numeric terminals comprehensively. According to terminal settings, inverter can run at a preset speed or at a speed determined through numeric setting, analog input, pulse or communication.

If all the numeric terminals are disabled, function code F00.04 is used to set present channel and is in arithmetic together with UP/DOWN to get the final setting.

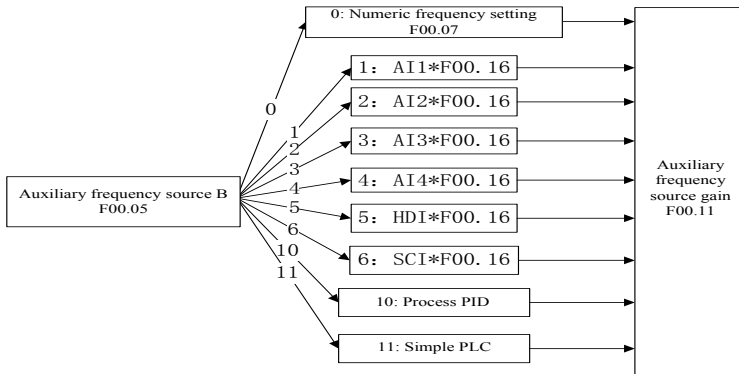

Figure 1-3 Auxiliary Frequency Source B Setting

As indicated in Figure 1-3, when auxiliary frequency source B is being set, the setting of F00.05 will be based upon to determine present setting channel. Process PID and Simple PLC can participate in the setting.

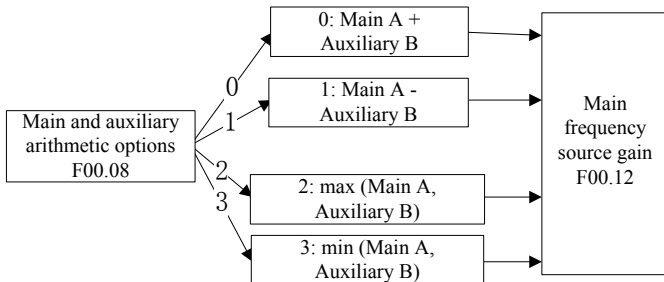

Figure 1-4 Main and Auxiliary Arithmetic Setting

As indicated in Figure 1-4, main and auxiliary arithmetic can be classified into four categories. At this time, both main and auxiliary settings are enabled.

- Torque setting mode: Motor current is taken as the control object.

Torque setting mode can be set by multiple ways, which include numeric setting, analog input setting, high-speed pulse input setting, communication setting, digital potentiometer setting and preset torque setting. In Figure 1-5, various input modes for torque setting of EM500 are described.

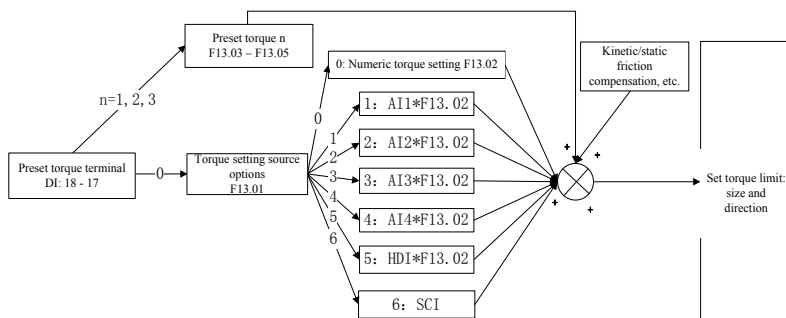



Figure 1-5 Torque Setting Mode

★ JOG speed setting is superior to other settings, i.e., when pressing  on keypad

or turning control terminals FJOG and RJOG on, inverter will automatically switch to jog speed setting, no matter what present setting mode is.

1.2.4 Control Modes of Inverter

Control modes of inverter refer to the modes to start/stop inverter. There are three control modes, namely keypad control mode, terminal control mode and communication control mode. The terminal control mode includes 2-wire sequence (RUN and F/R) and 3-wire sequence (RUN, F/R and Xi (i=1 - 7), Xi needs to be redefined as 3-wire start/stop control). Its running mode control logic is shown in Figure 1-6.

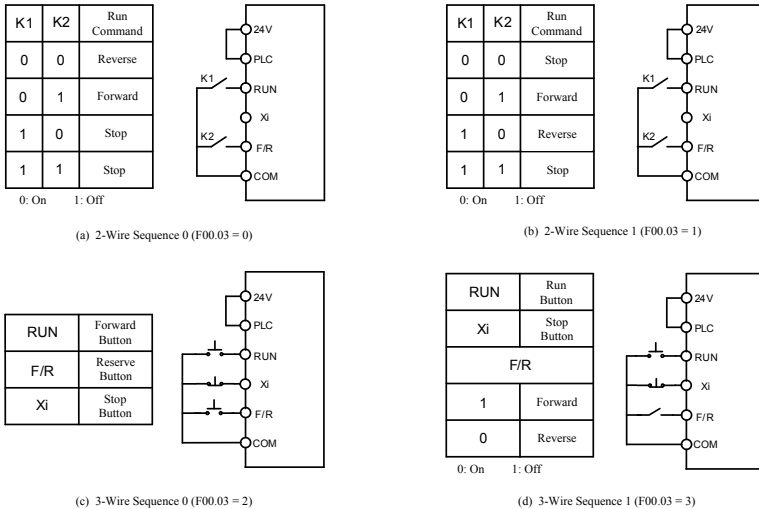

Figure 1-6 Control Logic of Terminal Control Mode

1.3 Description of Parts of EM500 Inverter

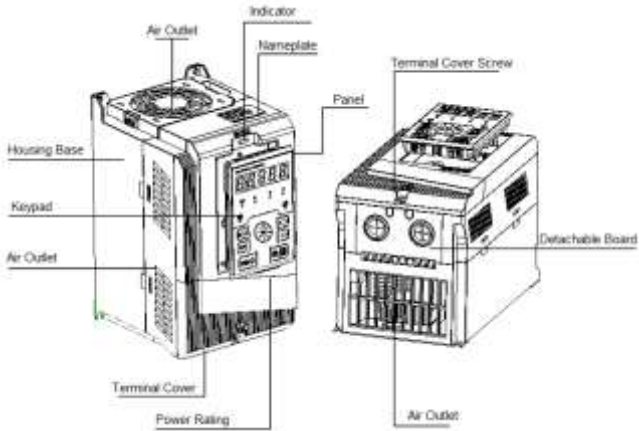

Figure 1-7 Description of Parts of EM500 Inverter (4 kW)

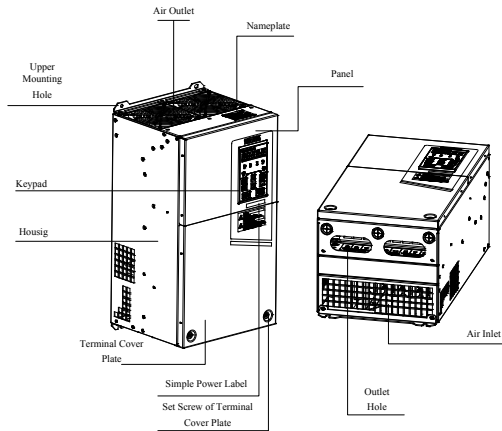

Figure 1-8 Description of Parts of EM500 Inverter (30 kW)

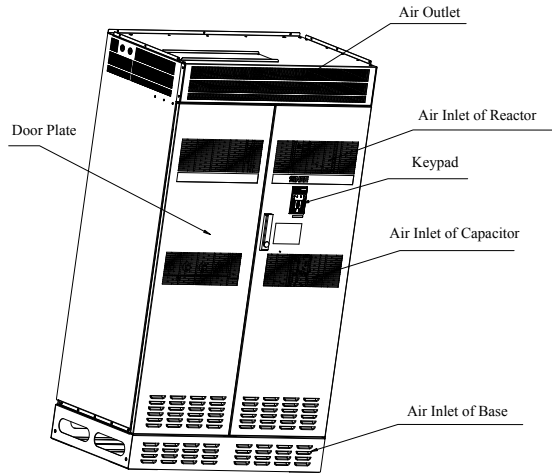

Figure 1-9 Description of Parts of EM500 Inverter (450kW)

2. Installation

2.1 Product Verification



Danger

Do not install inverter if it is damaged or any component is missing so as to avoid injury!

Please verify inverter products as per table 2-1 when you get them.

Table 2-1 Check List

Item	Method
Check if they are identical to the purchase order.	Check the nameplate at the side of inverter.
Any damage.	Check the overall appearance to see if they are damaged in transportation.
Any loosened screws or other fastening parts.	Check with a screwdriver if necessary.

If you find any quality problem, please contact SINEE Direct Sale Department or the distributor.

- **Nameplate**



● **Model Numbering Description**

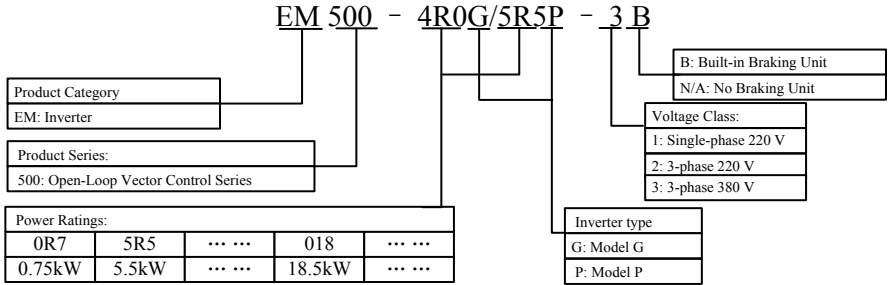

2.2 Overall and Installation Dimensions

EM500 inverters can be categorized into 30 specifications for 4 overall dimensions and 12 installation dimensions (as shown in Figure 2-1 and Table 2-2).

Keypad can be installed onto an iron panel separately with a hole size of 114.5±0.1(L)*71±0.1 (W) mm and the iron panel thickness of 1.2 - 2.0mm.

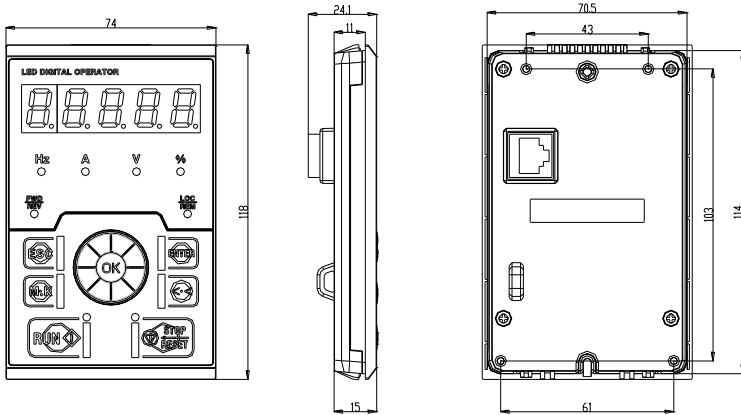

(a) Keypad Dimension

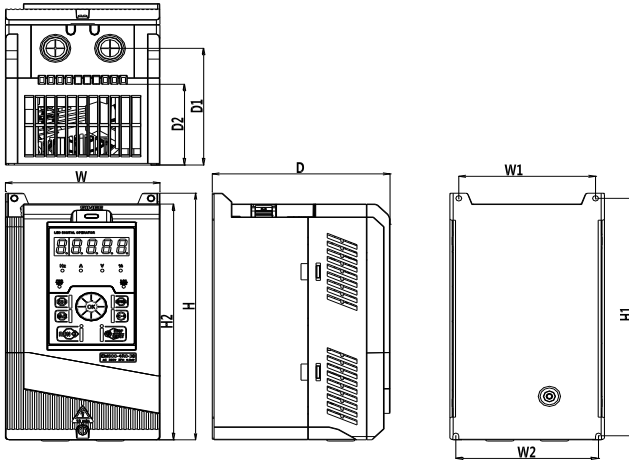

(b) Overall Dimensions of 0.75 kW – 18 kW Inverters

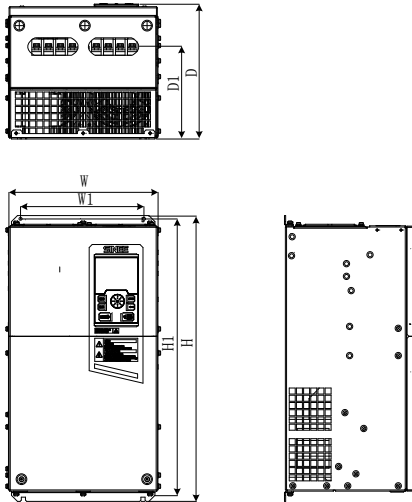

(c) Overall Dimensions of 22 kW – 75 kW Inverters

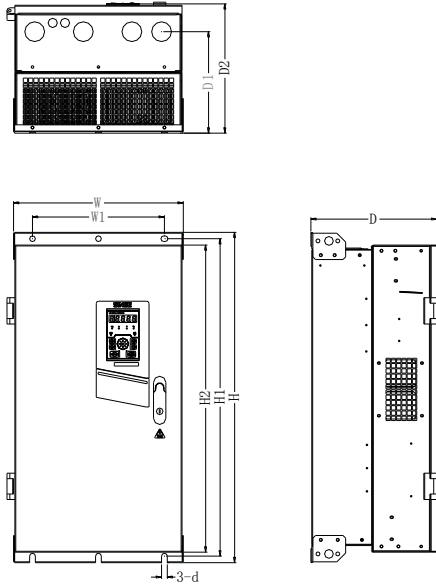

(d) Overall Dimensions of 90 kW – 400 kW Inverters

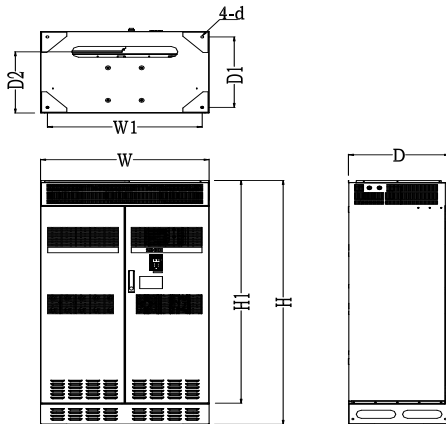

(e) Overall Dimensions of 450 kW – 560 kW Inverters

Figure 2-1 Overall Dimensions of EM500 Inverter and Keypad

Table 2-2 Overall and Installation Dimensions of EM500 Inverter

Model No.	W	W1/W2	H	H1	H2	D	D1	D2	d	Frame	
EM500-0R7G/1R5P-1B/ 2B/3B	130	115 / 120	228	220	219	153	108	75	5	(b)	
EM500-1R5G/2R2P-1B/ 2B/3B											
EM500-2R2G/3R0P-1B/ 2B/3B											
EM500-4R0G/5R5P-3B											
EM500-5R5G/7R5P-3B	140	130	270	261	258	172	128	94	5		
EM500-7R5G/9R0P-3B											
EM500-011G/015P-3B	180	150	368	353	343	210	165	136	7	(c)	
EM500-015G/018P-3B											
EM500-018G/022P-3B											
EM500-022G/030P-3/3B	250	200	484	470	440	222	150	--	6.5		
EM500-030G/037P-3/3B											
EM500-037G/045P-3/3B											
EM500-045G/055P-3/3B	315	200	560	546	513	250	180	--	7		
EM500-055G/075P-3/3B	350	250	662	638	603	262	188	--	12		
EM500-075G/905P-3/3B											
EM500-090G/110P-3	386	300	753	724	700	292	231	300	13		(d)
EM500-110G/132P-3	416	300	855	825	793	307	246	315	13		
EM500-132G/160P-3											
EM500-160G/185P-3	497	397	1107	1076	1036	340	285	348	13		
EM500-185G/200P-3											
EM500-200G/220P-3											
EM500-220G/250P-3	656	450	1348	1314	1261	388	232	395	13		
EM500-250G/280P-3											
EM500-280G/315P-3											
EM500-315G/355P-3	801	680	1417	1383	1330	388	190	395	13		
EM500-355G/400P-3											
EM500-400G/450P-3											
EM500-450G/500P-3											
EM500-500G/560P-3	1000	920	1800	1645	--	600	520	450	17	(e)	
EM500-560G/630P-3											

2.3 Considerations for Installation Site



Caution

When carrying and transporting inverter, please hold its bottom.

Only taking the face panel would result in the risk of hitting your foot due to its dropping.

Please install inverter onto a metal panel or other non-flammable material panel.

Installing it onto flammable materials may result in fire risk.

When at least two inverters are installed in the same control cabinet, please set a cooling fan and maintain the air temperature of air inlet below 40°C.

Overheating would result in a fire or other accidents.

Installation Site

The installation site shall have the following conditions:

1. Well-ventilated indoor place.
2. Ambient temperature: -10°C - 40°C .
3. Avoid high temperature and high moisture, humidity $< 90\%RH$, no water drops or any other condensation.
4. Do not install inverter onto wood or other flammable materials.
5. No direct sunlight.
6. No flammable or corrosive gas or liquid.
7. No dust, oily dust or floating fiber or metal particles.
8. Installation base shall be solid and free from vibration.
9. No electromagnetic interference and away from interference source.

Ambient Temperature

For reliability purpose, please install inverter at a well-ventilated place. A cooling fan or an air-conditioner shall be installed and the ambient temperature shall be kept below 40°C , when inverter is installed in a closed box.

Precautions

Please take precautions during installation to prevent metal fragments or dusts produced by drilling or other actions from falling into inverter. Remove precaution objects after installation.

2.4 Installation Direction and Space

A cooling fan must be installed for EM500 inverter for forced air cooling. Inverter must be installed in vertical direction with enough space maintained to an adjacent object or a baffle (wall) for better cooling effect (see Figure 2-2).

EM500 inverter (450 kW or above) must be installed with a cooling fan for forced air cooling. Its special air channel design enable cabinet to be installed at both left and right sides in parallel and only certain maintenance and operation space is required before and after cabinet.

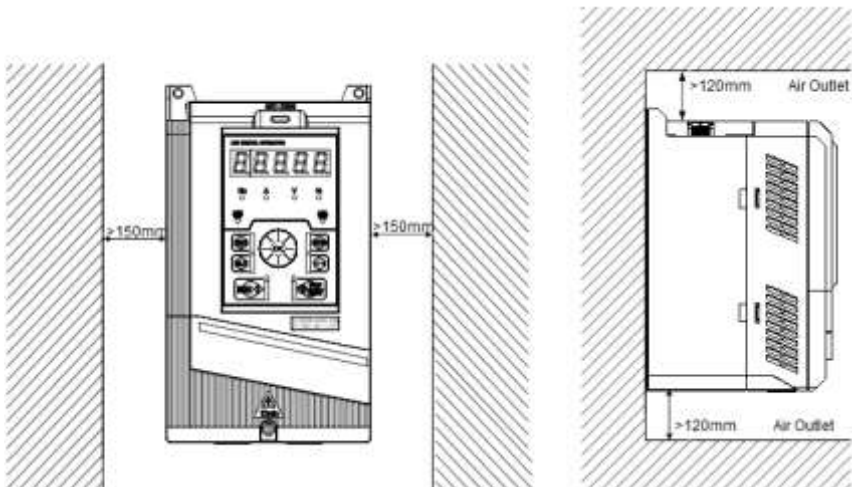

Figure 2-2 Inverter Installation Direction and Space

2.5 Assembly and Disassembly of Keypad

Generally it's not necessary to disassemble keypad while using an inverter. If necessary, observe the following methods to disassemble or install keypad. The keypad cover should be used for inverter 22kW and above if the keypad is disassembled

- Disassemble keypad: Put your fingers in finger slots on the top of keypad, press down keypad slightly and pull it outward (see Figure 2-3). For more than 22 kw inverter, after dismantling the keyboard, also need to use the attached cap to cover the hole.

Step 1:

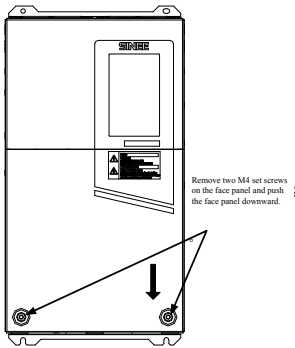

Step 2:

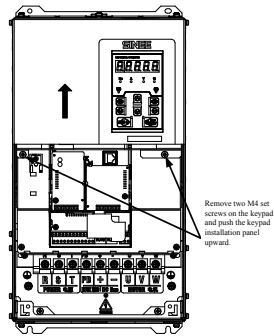

Step 3:

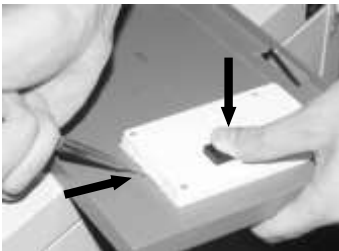

Step 4:

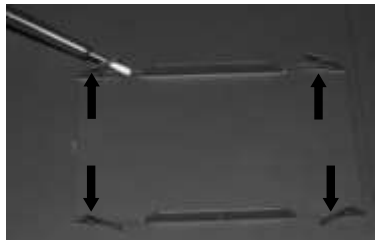

Figure 2-3 Disassemble Keypad

- Assemble keypad: Make RJ-45 terminal aligned with the modular plug at the keypad bottom horizontally, and press the keypad flatly until it clicks into the right place. See Figure 2-4.

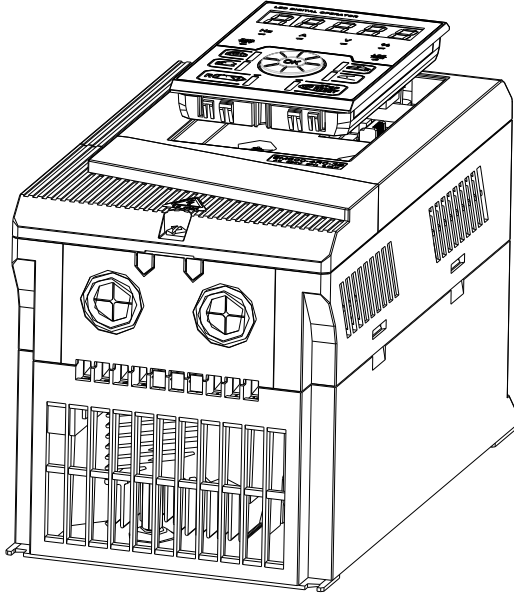

Figure 2-4 Keypad Installation

2.6 Flush Mounting

EM500 inverter (5.5 kW – 200 kW) can be changed to flush mounting type.

Installation of EM500 inverter (22 kW or above): Remove top and bottom mounting holes of original housing (Figure 2-5) to the position shown in Figure 2-6, and install the removed bolts back to the said mounting holes again.

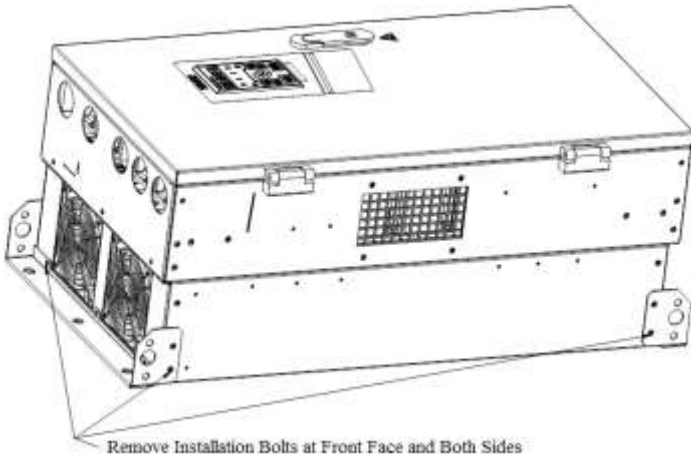

Figure 2-5 Disassemble Top and Bottom Mounting Holes

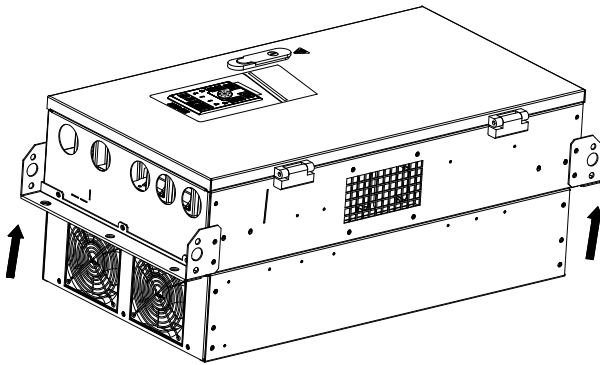

Figure 2-6 Assemble Top and Bottom Mounting Holes

Installation of EM500 inverter (below 22kW): As shown in 2-7, insert left and right accessories for flush mounting into the slots at the left and right sides of the plastic shell, and tighten the two front and back screws. See Figure 2-8 Installation Dimensions for Flush Mounting and Table 2-3 for installation dimensions.

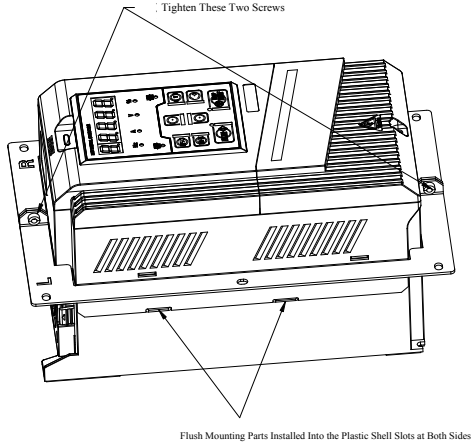
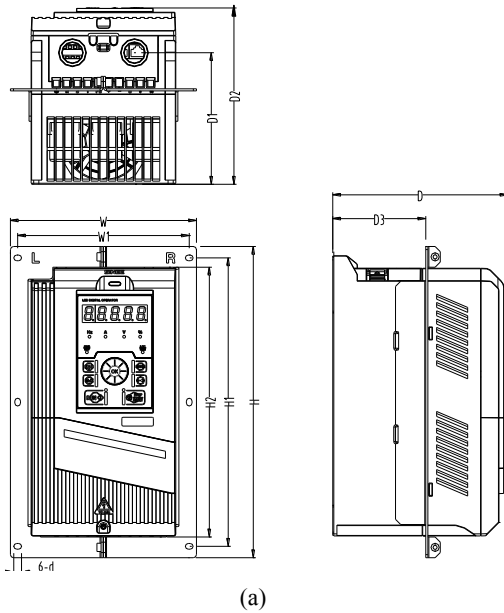
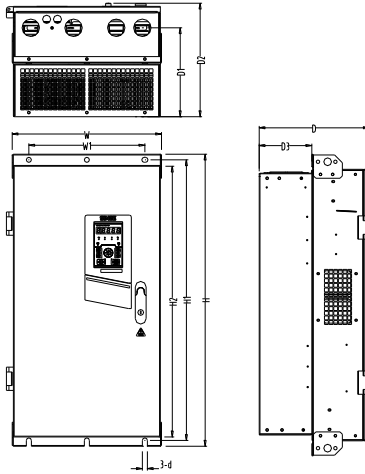

Figure 2-7 Left and Right Accessories for Flush Mounting





(b)

Figure 2-8 Installation Dimensions for Flush Mounting

Table 2-3 Installation Dimensions for Flush Mounting

Model No.	W	W1	H	H1	H2	D	D1	D2	D3	d	Frame
EM500-5R5G/7R5P-3B	188	166	300	278	258	172	128	172	90	5.5	a
EM500-7R5G/9R0P-3B											
EM500-011G/015P-3B	224	150	431	409	343	210	165	210	122	8	a
EM500-015G/018P-3B											
EM500-018G/022P-3B											
EM500-022G/030P-3/3B	250	200	484	470	440	214	150	222	122	6.5	b
EM500-030G/037P-3/3B											
EM500-037G/045P-3/3B											
EM500-045G/055P-3/3B	315	200	560	546	513	242	180	250	140	7	b
EM500-055G/075P-3/3B											
EM500-075G/905P-3/3B	350	250	662	638	603	254	188	262	138	12	b
EM500-090G/110P-3											
EM500-110G/132P-3	416	300	855	825	793	302	246	310	132	13	b
EM500-132G/160P-3											
EM500-160G/185P-3											
EM500-185G/200P-3	497	397	1107	1076	1036	335	285	343	145	13	b
EM500-200G/220P-3											

3. Wiring

3.1 Connection to Peripherals

Standard connection between EM500 and peripherals is shown in Figure 3-1.

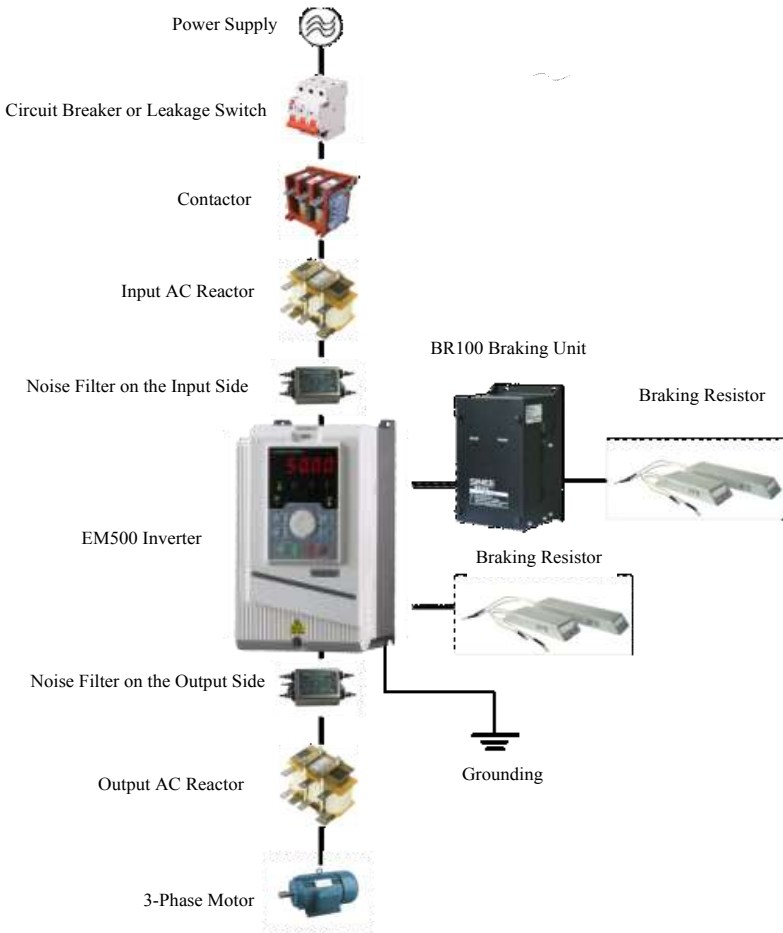

Figure 3-1 Connection of EM500 Inverter and Peripherals

3.2 Wiring Main Circuit Terminals

3.2.1 Main Circuit Terminal Block

The main circuit terminals of EM500 comprise the following parts:

- 3-phase AC input terminals: R, S and T
- Grounding terminal: \perp
- DC bus terminal: $\oplus \ominus$
- Wiring terminal for energy consumption braking resistor: \oplus , PB
- Wiring terminals of motor: U, V and W

See Figure 3–2 for main circuit terminal block.

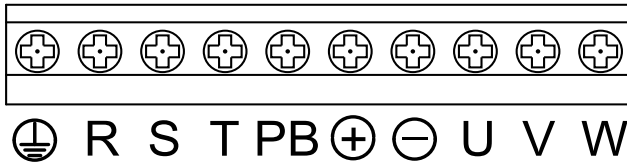

a) Main Circuit Terminal Block of Models 0.75 - 7.5 kW

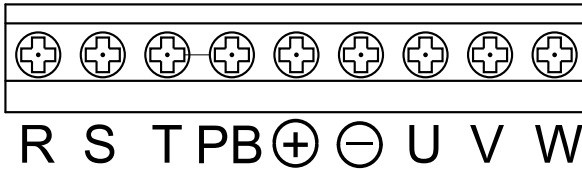

b) Main Circuit Terminal Block of Models 11 - 18.5 kW

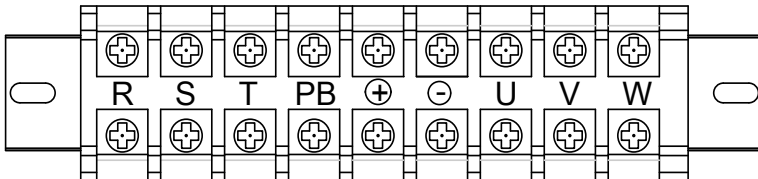

c) Main Circuit Terminal Block of Models 22 - 37 kW

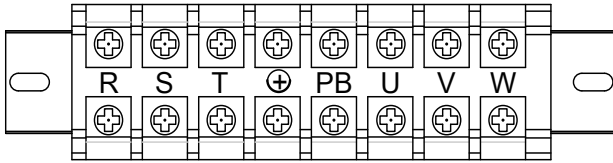

d) Main Circuit Terminal Block of Models 45 - 75 kW

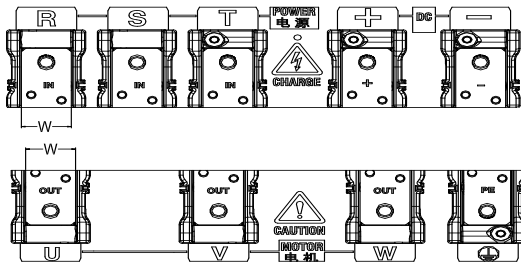

e) Main Circuit Terminal Block of Models 90 - 200 kW

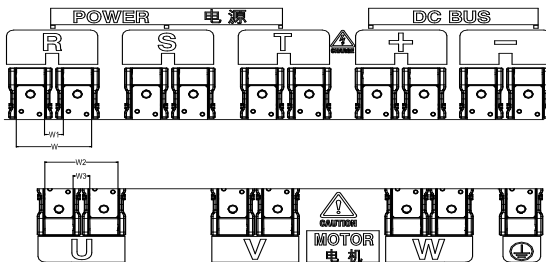

f) Main Circuit Terminal Block of Models 220 - 400 kW

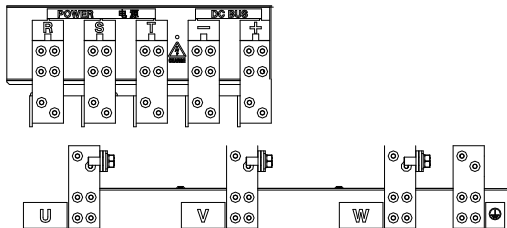

g) Main Circuit Terminal Block of Models 450 - 560 kW

Figure 3-2 Main Circuit Terminal Block

Table 3-1 90 kW – 400 kW Terminal Dimension

Model No.	W	W1	W2	W3
EM500-090 to EM500-132	33	-	-	-
EM500-160 to EM500-200	39	-	-	-
EM500-220 to EM500-280	88	22	88	22
EM500-315 to EM500-400	104	26	101	23

Note: 90 kW or above: Power input terminals are on the top and power output terminals are at the bottom of inverter. 220 - 400 kW or above: There are 2 wiring terminal blocks for each phase.

3.2.2 Main Circuit Terminal Functions

The main circuit terminal functions of EM500 are shown in Table 3–2 and please correctly wire terminals according to functions.

Table 3–2 Main Circuit Terminal Functions

Terminal No.	Function Description
R, S and T	AC power supply input terminal, to connect to 3-phase AC power supply.
U, V and W	AC output terminals of inverter, to connect to 3-phase AC motor.
⊕ ⊖	Positive and negative terminals of internal DC bus, to be connected to the external braking unit.
⊕ and PB	Braking resistor connection terminals, one end connected to ⊕ and the other end to PB.
⊕	Grounding terminal.

3.2.3 Internal Main Circuit

The internal main circuit structure of EM500 is shown in Figure 3–3.

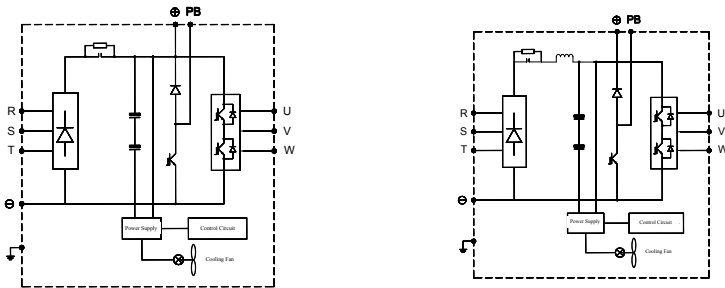

a) EM500-0R7G/1R5P-3B-EM500-7R5/9R0P-3B b) EM500-011G/015P-3B-EM500-018G/022P-3B

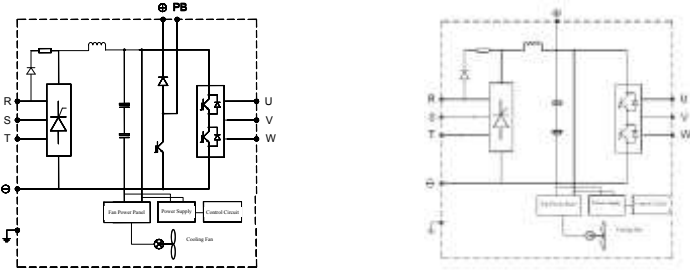

c) EM500-022G/030P-3B~ EM500-075G/090P-3B d) EM500-022G/030P-3~EM500-200G/220P-3

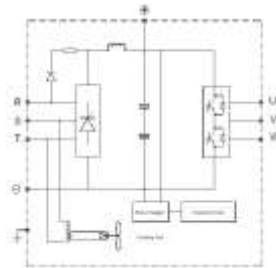

e) EM500-220G/250P-3~ EM500-560G/630P-3

Figure 3-3 Internal Main Circuit of Inverter

3.2.4 Standard Wiring of Main Circuit

The standard wiring of the main circuit of EM500 inverter is shown in Figure 3-4.

● EM500-0R7-3B - EM500-018-3B

● EM500-022-3 - EM500-560-3

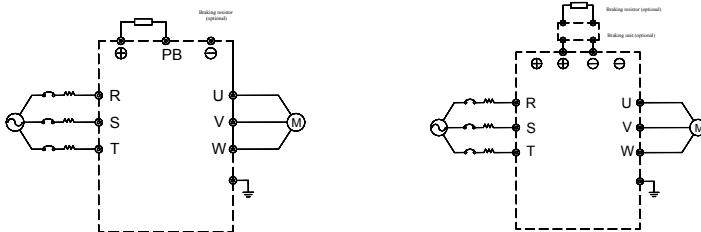

Figure 3-4 Standard Wiring of Main Circuit

3.2.5 Wiring on Input Side of Main Circuit

3.2.5.1 Circuit Breaker Installation

An air circuit breaker (MCCB) corresponding to inverter is required between power supply and input terminals.

- The capacity of MCCB shall be 1.5 to 2 times that of the rated current of inverter.
- The time characteristics of MCCB must meet the time characteristics of the overheating protection of inverter (150% rated current/1 minute).
- When MCCB is used with multiple inverters or other devices, please connect the contactor of the fault output relay to power contactor coil, so that the power supply will be turned off by a fault signal (Figure 3-5).

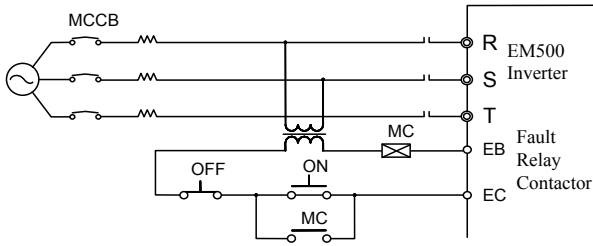

Figure 3-5 Connecting to Input Circuit Breaker

3.2.5.2 Leakage Circuit Breaker Installation

Inverter outputs high-frequency PWM signal, which generates high-frequency leakage current. Please select a leakage circuit breaker with trigger current $\geq 30\text{mA}$. For a regular circuit breaker, the trigger current $\geq 200\text{mA}$ and the active time at 0.1 s or above.

3.2.5.3 Electromagnetic Contactor Installation

Connect the electromagnetic contactor corresponding to inverter power as shown in Figure 3-4.

- Do not control the start or stop of inverter with the electromagnetic contactor on the input side. Frequent use of this method is an important cause of damaging inverter. The operation interval between start and stop of inverter

shall not be longer than once every 30 minutes.

- Inverter will not automatically start after power failure.

3.2.5.4 Connection to Terminal Block

Input power can be connected to R, S and T randomly irrespective of their phase sequence on the terminal block.

3.2.5.5 AC Reactor Installation

Excessive surge current may be generated when inverter is connected to a large capacity (over 600KVA) power transformer or the input power supply is connected to a capacitive load, and this may damage the rectifier. Connect a 3-phase AC reactor (optional) to the input side of inverter, which not only suppresses peak current and voltage, but also improves the power factors of system.

3.2.5.6 Surge Suppressor Installation

It's required to install a surge suppressor, if there is an inductive load near inverter, for example electromagnetic contactor, solenoid valve, solenoid coil and electromagnetic circuit breaker.

3.2.5.7 Noise Filter Installation at Power Supply Side

A noise filter can filter the noise transmitted between power cable and inverter and the impacts of the noise generated by inverter on the power grid.

- A special noise filter is required for an inverter; a general noise filter is not adopted usually for performance purpose.
- Correct and incorrect installation methods of a noise filter are shown in Figure 3-6 and Figure 3-7.

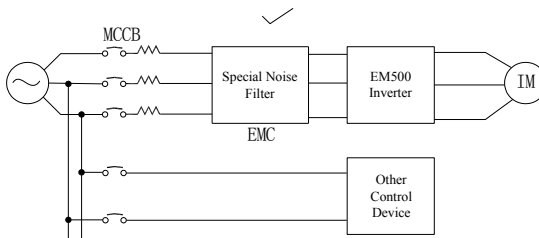

Figure 3-6 Correct Installation of Noise Filter

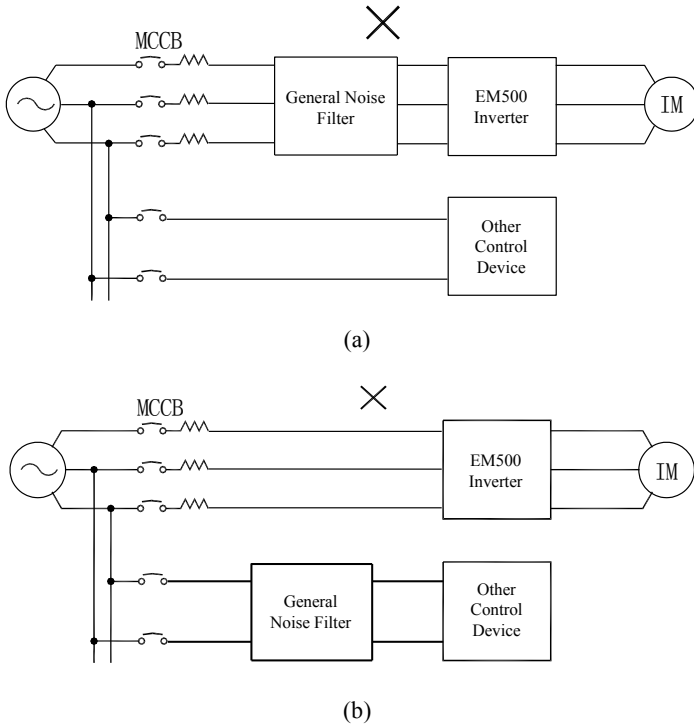

Figure 3-7 Incorrect Installation of Noise Filter

3.2.6 Wiring on Output Side of Main Circuit

3.2.6.1 Inverter and Motor Connection

Connect output terminals U, V or W of inverter to input terminals U, V or W of motor.

Confirm whether a motor runs forward after receiving a forward running command during inverter running. If not, please switch any two connection cable of output terminals U, V and W of inverter.

3.2.6.2 Never Connect Power Supply Cable to Output Terminals

Never connect power supply cable to output terminals. If output terminals are connected to power supply, the internal parts of inverter would be damaged.

3.2.6.3 Never Short-Circuit or Ground Output Terminals

Never touch output terminals with bare hands or connect output cable to inverter housing, so as to avoid electric shock or short circuit. In addition, do not short-circuit the output cable.

3.2.6.4 Never Use an Phase-Shifting Capacitor

Never connect a phase-shifting electrolytic capacitor or an LC/RC filter to output circuit so as to prevent inverter from being damaged.

3.2.6.5 Never Use an Electromagnetic Switch

Do not connect a solenoid switch or an electromagnetic contactor to output circuit. Otherwise, it will trigger the action of overcurrent or overvoltage protection circuit or damage the internal parts of inverter.

To set an electromagnetic contactor for the switch of the power supply, stop inverter and motor at first.

3.2.6.6 Noise Filter Installation at Output Side

Connecting a noise filter to the output side of inverter can reduce inductive interference and radio interference.

- Inductive interference: Signal line contains noises due to electromagnetic induction, thus resulting in incorrect actions of control devices.
- Radio interference: High-frequency electromagnetic waves transmitted by inverter and cable will cause radio devices nearby to make noises while receiving signal.
- Noise filter installation is installed on the output side is shown in Figure 3–8.

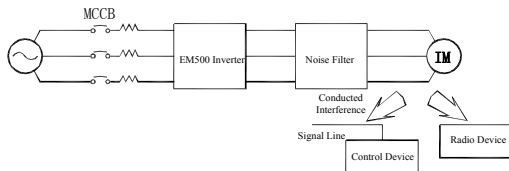

Figure 3-8 Noise Filter Installation on the Output Side

3.2.6.7 Countermeasures Against Inductive Interference

In addition to the installation of a noise filter, the method of wiring all output cable into grounded metal pipe can be adopted to suppress the inductive interference on the output side. The distance between output cable and signal line shall be greater than 30 cm and the inductive interference decreases substantially, as shown in Figure 3–9.

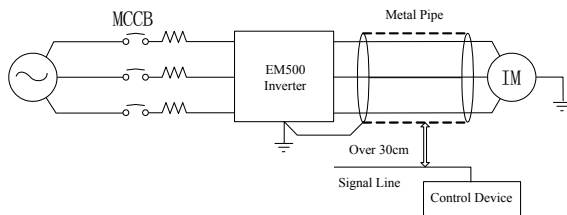

Figure 3-9 Countermeasures Against Inductive Interference

3.2.6.8 Countermeasures Against RF Interference

RF interference can be produced by input cable, output cable and inverter and reduced by installing a noise filter on both input and output sides and covering inverter with an iron box. See Figure 3–10 for detail.

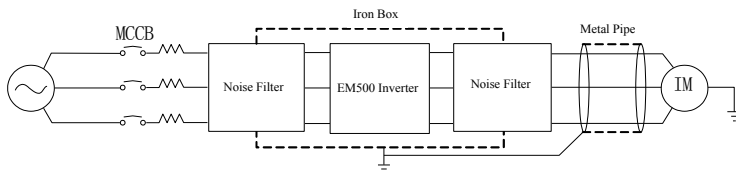

Figure 3–10 Countermeasures Against RF Interference

3.2.6.9 Wiring Distance Between Inverter and Motor

The longer the wiring distance between inverter and motor is, the higher the carrier frequency will be and the greater the high-frequency harmonic leakage current on its cable will be accordingly. As a result, an adverse impact can be produced upon inverter and its devices nearby. Adjust the carrier frequency by reference to table 3-3 to reduce the high-frequency leakage current.

If motor cable is over 50m, connect a 3-phase inverter output AC reactor of the same capacity to terminals U, V or W of inverter.

Table 3-3 Wiring Distance and Carrier Frequency Between Inverter and motor

Wiring Distance Between Inverter and Motor	Below 50 m	Below 100 m	Above 100 m
Carrier Frequency	Below 10 kHz	Below 8 kHz	Below 5 kHz
F00.23	10.0	8.0	5.0

3.2.7 Main Circuit Cable and Terminal Screw Size

Main circuit cable and terminal screw sizes are shown in Table 3-4.

Table 3-4 Cable and Terminal Screw Specifications

Model No.	Terminal Screw	Tightening Torque (N.m)	Cable Size (mm ²)	Cable Type
EM500-0R7G/1R5P-1B/2B/3B	M3.5	1.2 - 1.5	1.5	750 V cable
EM500-1R5G/2R2P-1B/2B/3B			2.5	
EM500-2R2G/3R0P-1B/2B/3B			4	
EM500-4R0G/5R5P-3B				
EM500-5R5G/7R5P-3B	M4	1.5 - 2.0	6	
EM500-7R5G/9R0P-3B	M5	3.0 - 4.0	10	
EM500-011G/015P-3B				
EM500-015G/018P-3B				
EM500-018G/022P-3B				
EM500-022G/030P-3/3B	M6	4.0 - 5.0	16	
EM500-030G/037P-3/3B			25	
EM500-037G/045P-3/3B	M8	9.0 - 10.0	35	
EM500-045G/055P-3/3B				
EM500-055G/075P-3/3B	M10	17.0 - 22.0	60	
EM500-075G/905P-3/3B				

EM500-090G/110P-3				
EM500-110G/132P-3			90	
EM500-132G/160P-3			120	
EM500-160G/185P-3	M12	31.0 – 39.0	180	
EM500-185G/200P-3				
EM500-200G/220P-3				
EM500-220G/250P-3				
EM500-250G/280P-3	2*M10	17.0 – 22.0	2*120	
EM500-280G/315P-3				
EM500-315G/355P-3			2*150	
EM500-355G/400P-3	2*M12	31.0 – 39.0	2*180	
EM500-400G/450P-3				
EM500-450G/500P-3				
EM500-500G/560P-3	2*M16	45.0 – 55.0	2*270	
EM500-560G/630P-3				

Note: 1. Take the voltage drop into consideration for selecting cable. Generally speaking, the voltage drop value calculated by the following formula shall be less than 5V.

$$\text{Voltage drop} = \sqrt{3} * \text{Cable Resistivity } (\Omega/\text{KM}) * \text{Cable Length (m)} * \text{Rated Current (A)} * 10^{-3}$$

2. If power cable is laid in a plastic duct, it shall be one grade higher.

3. Cable shall be connected to round wiring terminals of applicable cable and terminal screw.

4. The size of grounding cable should be the same as the power cable if the selected power cable is less than 16 mm², or not less than 1/2 of the power cable if the selected power cable is greater than 16 mm². Anyway, at least 16 mm² is a must.

3.2.8 Grounding Cable

- Ground terminal \perp must be grounded.
- The third type grounding method specially (grounding resistance less than 10 Ω) must be adopted.
- Never share the grounding cable with welder or power device.

- Please select the grounding wire of the specifications as stipulated in the Technical Standards of Electrical Equipment and keep it as short as possible when connecting to the ground point.
- Do not allow the grounding cable to form a circuit when two or more inverters are used. Correct and incorrect grounding methods are shown in Figure 3–11.

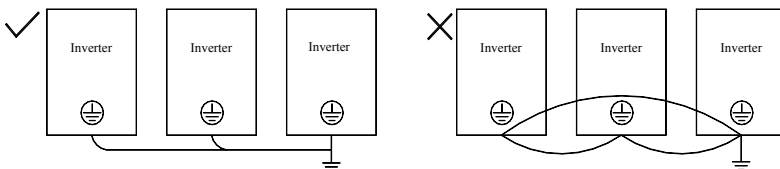

Figure 3-11 Connection Methods of Grounding Cable

3.2.9 Braking Resistor and Braking Unit Wiring

See Chapter 11 for type selection and wiring methods of braking resistor and braking unit.

3.3 Wiring Control Circuit Terminals

3.3.1 Control Circuit Terminals

Control circuit terminals are located at the bottom front of terminal block and PCB and comprise:

- Analog input terminals: AI1, AI2 and AI3
- Numeric input terminals: X1, X2, X3, X4, X5, X6 and X7
- Numeric output terminals: Y1 and Y2
- Relay output terminals: R1: EA-EB-EC, R2: RA-RB-RC
- Analog output terminals: M1 and M2
- Auxiliary power supply terminals: PLC, +24V, COM, +10V and GND
- RS485 communication interface: A+ and A-
- CANsine interface: CANH and CANL (optional)
- Ground terminal: PE

See Figure 3–12 for control circuit terminal block.

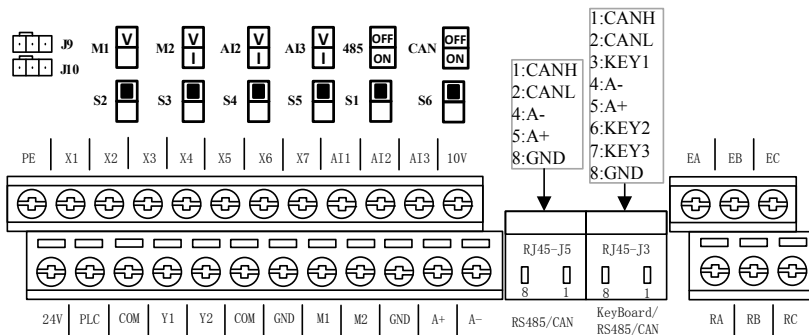

Figure 3-12 Control Circuit Terminal Block

Note: 1. Jump wires J9 and J10 of the terminal block are equipped by the manufacturer. No user is allowed to change them, or else inverter may not work normally. 2. S2 is VOID. M1 is analogy output ONLY for DC 0~10V.

3.3.2 Function and Wiring of Control Circuit Terminals

See Table 3–5 for functions of control circuit terminals.

Table 3-5 Control Circuit Terminal Functions

Mode	Terminal No.	Terminal	Terminal Function
Auxiliary Power Supply	10V-GND	+10V Power Supply	Offers a +10V power supply, maximum output current: 20mA.
	24V-COM	+24V Power Supply	Offers +24V power supply, generally used as a working power supply for numeric input or output terminal, or external device power supply. Maximum output current: 200mA.
	PLC	Common Multi-function Input Terminal	As factory default, it is connected to 24 V power supply. When driving numeric input terminal with an external power supply, disconnect it from 24V terminal and connect it to external power supply.
Analog Input	AI1-GND	Analog Input	Input voltage range: DC 0 - 10 V

EM500 Open-Loop Vector Control Inverter User Manual

		Terminal 1	Input impedance: 1M Ω
	AI2-GND	Analog Input Terminal 2	Input range: DC 0 - 10 V/0 - 20 mA; select the voltage/current mode by switch S4 on the terminal block Input impedance: Voltage mode 1 M Ω , current mode 250 Ω
	AI3-GND	Analog Input Terminal 3	Input range: DC 0 - 10 V/0 - 20 mA; select voltage/current mode by switch S5 on the terminal block. Input impedance: Voltage mode 1 M Ω , current mode 250 Ω
Numeric Input	X1-COM	Multi-function Input Terminal 1	Optocoupler isolation, compatible with bipolar input of NPN and PNP. Input impedance: 4.5 k Ω Input voltage range: 9 - 30 V
	X2-COM	Multi-function Input Terminal 2	
	X3-COM	Multi-function Input Terminal 3	
	X4-COM	Multi-function Input Terminal 4	
	X5-COM	Multi-function Input Terminal 5	
	X6-COM	Multi-function Input Terminal 6	
	X7-COM	High Speed Pulse Input Terminal	In addition to being used as multi-function input terminal, it can be used as high speed pulse input terminal as well with maximum response frequency of 100 kHz. Input voltage: 12 - 48 V Input impedance: 1 k Ω

Analog Output	M1-GND	Analog Output Terminal 1	Output range: DC 0 - 10 V. S2 is VOID.
	M2-GND	Analog Output Terminal 2	Output range: DC 0 - 10 V/0 - 20 mA; selected by switch S3 on the terminal block.
Multi-Function Output	Y1-COM	OC Output Terminal	Optocoupler isolation, OC output Maximum output voltage: DC 48V Output current: 50 mA
	Y2-COM	High Speed Pulse Output Terminal	Optocoupler isolation, OC output Maximum output voltage: DC48V Maximum output current: 50 mA For high speed pulse output, maximum output frequency 100 kHz Output impedance <5 kΩ
Relay Output	R1:EA-EB-EC R1: EA-EB-EC	Relay Output Terminal	EA-EC: NO EB-EC: NC
	R2:RA-RB-RC R2: RA-RB-RC		RA-RC: NO RB-RC: NC
Communication	A+	RS-485 Communication Interface	RS485 communication input (+)
	A-		RS485 communication input (-)
	CANH	CANSinee Communication Interface	CAN communication input (+)
	CANL		CAN communication input (-)
Shield	PE	Shielded Ground	For shielded ground of terminal cable

3.3.3 Analog Input Terminal Wiring

3.3.3.1 Wiring Terminals AI1, AI2 and AI3 Through Analog Voltage Signal:

When selecting the analog voltage signal input for terminals AI2 and AI3, configure the voltage mode through switches S4 and S5 of the terminal block (see Figure 3–13).

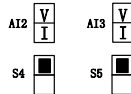

Figure 3-13 Configuring Voltage Modes with S4 and S5

When analog voltage input signal is powered by external power supply, terminals AI1, AI2 and AI3 are wired as Figure 3-14-a.

When analog voltage input signal is generated by potentiometer, terminals AI1, AI2 and AI3 are wired as Figure 3-14-b.

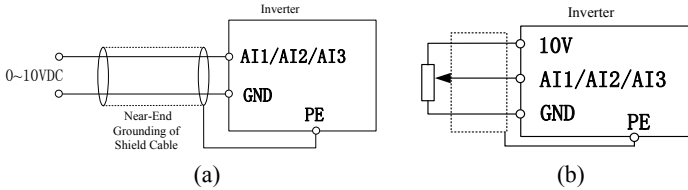

Figure 3-14 Wiring of Terminals AI1, AI2 and AI3

3.3.3.2 Wiring Terminals AI2 and AI3 (Input Analog Current Signal):

When selecting analog current signal input on terminals AI2 and AI3, configure current mode through switches S4 and S5 of the terminal block. See Figure 3-15 for detail.

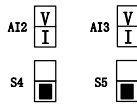

Figure 3-15 Configuring Current Modes with S4 and S5

3.3.4 Wiring of Terminals AI2 and AI3 (as shown in Figure 3-15)

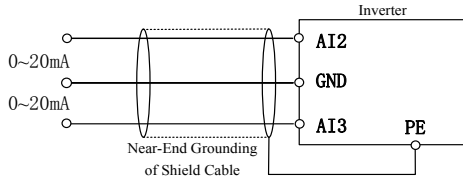

Figure 3-16 Wiring of Terminals AI2 and AI3

3.3.5 Wiring of Multi-function Input Terminal

Multi-function input terminals of EM500 inverter adopt full bridge rectifier. PLC terminal is a common terminal for X1-X7. The current passing through PLC terminal can be either forward (NPN Mode) or reverse (PNP Mode), so that it is flexible to connect terminals X1 - X7 to external devices. Typical wiring methods are shown in the

following:

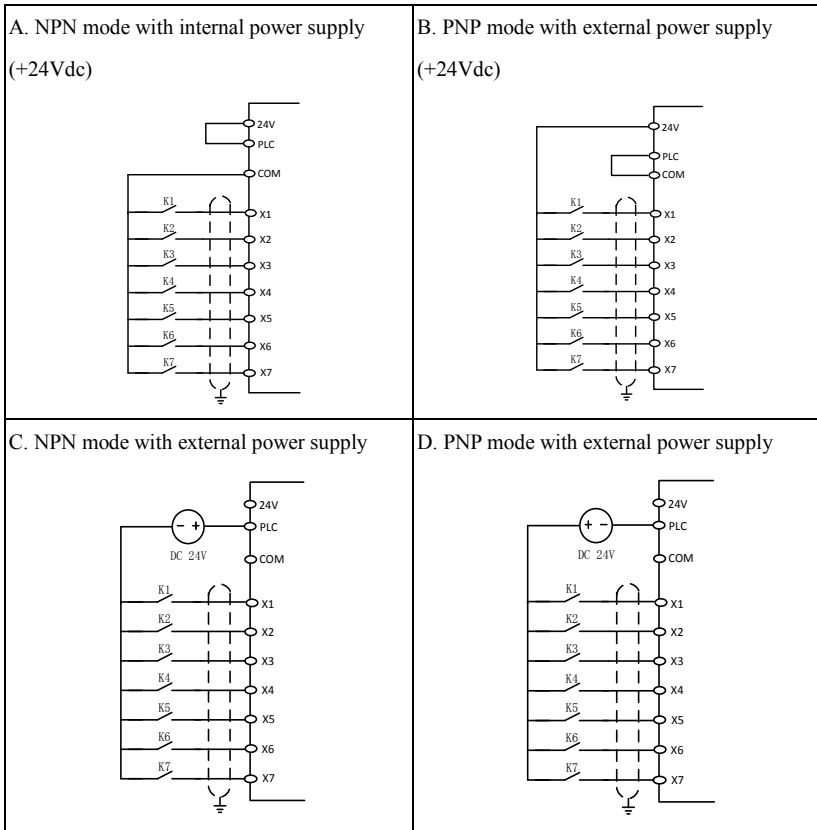

Figure 3-17 Wiring of Multi-function Input Terminals

Note: Wiring of relay output terminal of the short-circuiting bar between 24V power supply and PLC terminal must be removed, before using an external power supply.

Absorption circuit of surge voltage should be installed to drive the inductive load (for example relay and contactor), for example RC absorption circuit (please note that the leakage current should be less than the holding current of the contactor or relay under control), VDR and fly-wheel diode (for DC electromagnetic circuit, please pay attention to the polarity at installation). Components of absorption circuit should be installed near two sides of relay or contactor coil.

3.3.6 Wiring of Multi-function Output Terminal

Y1 and Y2 can be powered by internal 24V power supply or external power supply (see Figure 3-17).

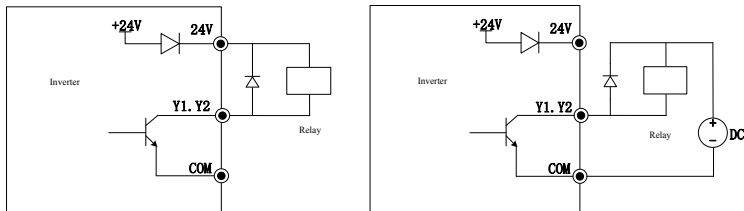

a: internal power supply







b: external power supply

Figure 3-18 Wiring of Multi-function Output Terminal

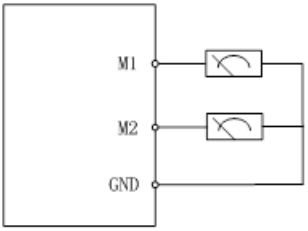
 1. An antiparallel diode must be added, in order to use an internal power supply (see Figure 3-18-a).

3.3.7 Analog Output Terminal Wiring

External analog board of analog output terminals M2 may indicate multiple physical quantities. Select (0 - 20 mA) or (0 - 10 V) by DIP switch; M2 corresponds to S3. M1 is analogy output ONLY for DC 0~10V. Wiring of DIP switch and terminal is as follows:

	 S2		Switch is invalid ,M1 for analog voltage output
			
	 S3		M2 for analog voltage output
			M2 for analog current output

3.3.8 Wiring of 485 Communication Terminal

Communication terminals A+ and A- are RS485 communication interfaces of inverter. Realize networking control of host controller (PLC or PLC controller) and

inverter by connecting to host controller for communication. RS485, RS485/RS232 converter and EM500 inverter are wired as shown in Figures 3-18, 3-19 and 3-20.

- RS485 terminal of single inverter directly connects to host controller for communication:

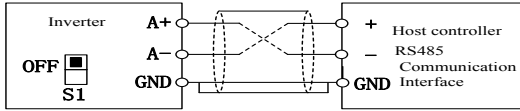

Figure 3-19 Wiring of Single Inverter Communication Interface

- RS485 terminals of multiple inverters connect to host controller for communication:

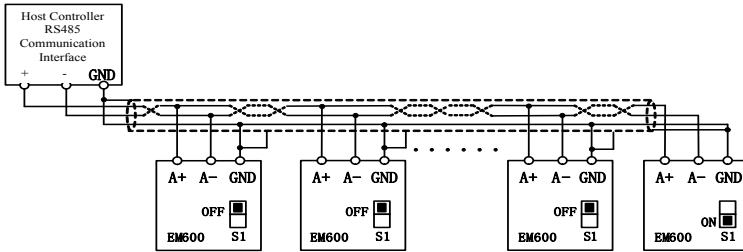

Figure 3-20 Wiring of Communication Interfaces of Multiple Inverters

- Connect to host controller for communication through RS485/RS232 converter

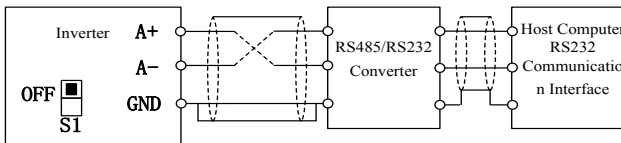

Figure 3-21 Wiring of Communication Interface

3.3.9 Wiring of CANSine Communication interface

The terminal board RJ45 interface CANH, CANL is the frequency changer CANSine main line connection, through the connection with on host machine

communication, achieve PC (PC or PLC controller) and the inverter network control. More than one inverter is connected, multi-machine communication can be achieved between. PC and EM500 series inverter connected as shown in Figure 3 22, Figure 3 23 shows.

Single inverter CANSinee bus directly connected with the host computer Communication:

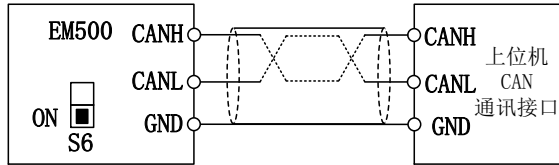

Figure 3 22 single inverter CANSinee communication wiring

Multiple inverter CANSinee bus connection with the host computer Communication:

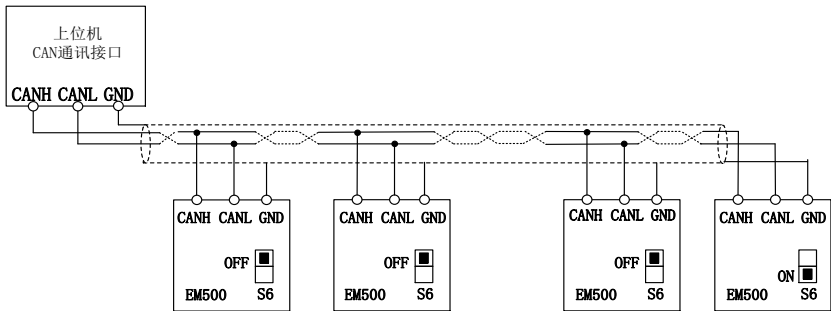

Figure 3 23 CANSinee communication wiring of several inverters



1. Multiple inverter CANSinee communication using terminal board RJ45

interface connection, the connection should pay attention to RJ45 interface input and output sequence should be consistent, in accordance with the "No. 1 machine port 2--2 machine port 1-2-2 machine port 2 - 3 port 1".

3.3.10 Control Circuit Cable and Screw Size

- The length of cable for transmitting control signal should be limited to 50 m and its distance from power cable should be greater than 30 cm, in order to reduce interference and attenuation of control signal. Please use shielded twisted-pair cable when analog signal is input externally.
- It's recommended to use 0.5 - 1 mm² cable as the control circuit cable.
- Terminal block of EM500 inverter shall be through control circuit connection terminal. Please use a cross screwdriver PH0 for installation with tightening torque of 0.5 N.m.

3.3.11 Attentions for Control Circuit Wiring

- Separate control circuit cable from other cable.
- Separate cable of control circuit terminals EA, EB, EC, Y1 and Y2 from the cable of other control circuit terminals.
- To prevent malfunctions caused by interference, use shielded twisted-pair cable for control circuit, with the wiring distance being less than 50m.
- Wrap exposed shield net with insulating tape to prevent the shield net from contacting other signal cable and housing of device.
- It's not allowed to contact various ports or components without ESD measures.

3.3.12 Standard Wiring of Control Circuit

Standard wiring of control circuit of EM500 inverter is shown in Figure 3–22.

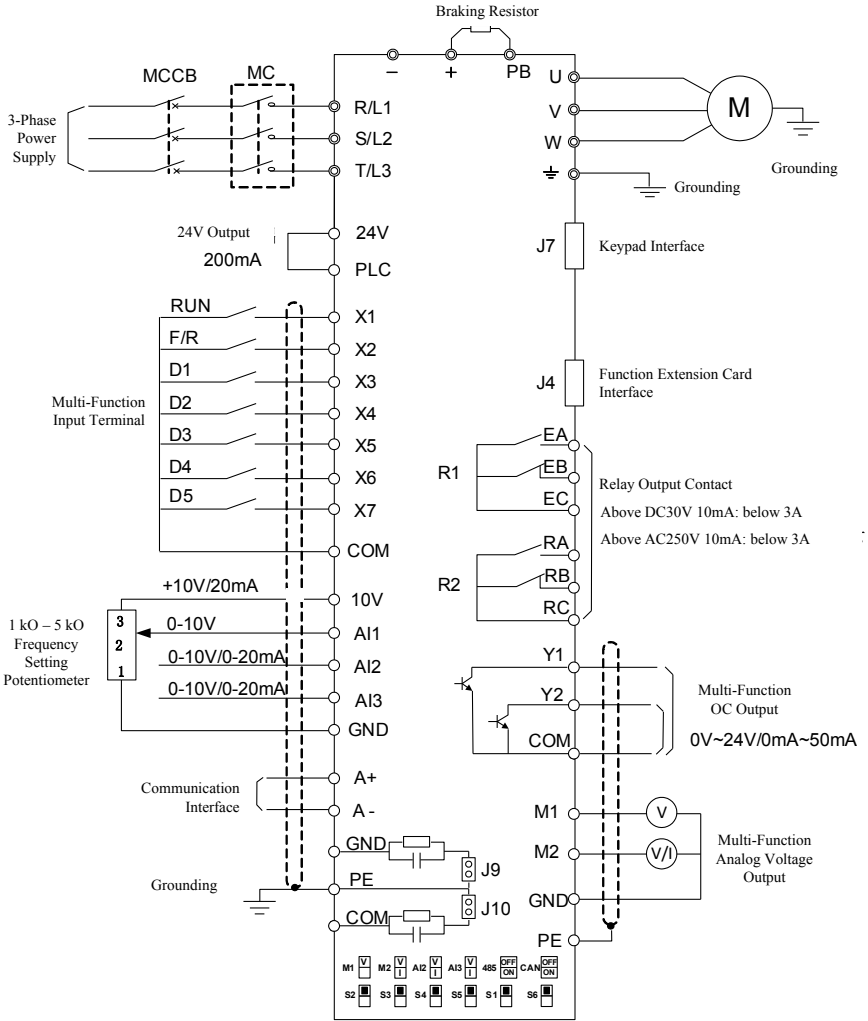

M1 is analogy output ONLY for DC 0~10V.

Figure 3-24 Standard Wiring of Control Circuit

3.4 Extending Keypad Wire

- 1) External keypad interface adopts RJ45 interface and the extending wire is common network cable (connection plug executes standard EIA/TIA568B).
- 2) See Figure 3-22 for wiring of keypad extension line.

This wiring mode will facilitate your installation and debugging greatly.

It's not recommended that keypad extension line be longer than 30m.

If cable above cat5 is used and electromagnetic environment is good, the extension line can be up to 50 m.

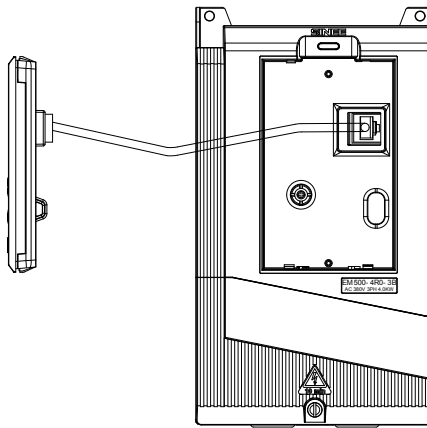

Figure 3-25 Wiring of Keypad Extension Line

3.5 Wiring Verification

Verify the following items after wiring:

- Whether wiring is incorrect.
- Whether there are screws, connector plugs or wire fragments inside inverter.
- Whether screws are loosened.
- Whether bare wire on one terminal connects to other terminals.

4. Keypad Operation

4.1 Keypad Function

4.1.1 Structure of LED Keypad

Control panels of EM500 can be classified into two categories: LED keypad and LCD keypad.

LED keypad comprises a 5-bit LED display, 6 operation buttons, 1 digital potentiometer and 8 status and unit indicators.

A user can operate inverter by keypad for parameter setting, status monitoring, start/stop operation, etc. Appearance and function zone of keypad are as shown in Figure 4-1.



















Figure 4-1 LED Keypad

4.1.2 Functions of Buttons and Indicators of LED Keypad

Functions of buttons and indicators of LED keypad are shown in Table 4-1.

Table 4-1 Functions of Buttons and Indicators of LED Keypad

Button/Indicator	Name	Function
	Right Shift	Select the group number and the function code Switch monitoring parameters
	Escape	Back to previous menu. Escape from editing present parameter by entering menu mode from monitoring mode.
	Multi-Functional Programmable Button	For non-function, JOG forward, JOG reverse, forward/reverse switch, top-speed stop, coast to stop options and cursor left shift, select any of it through function code F12.00.
	Enter	Enter the next menu. Confirm and save parameter modification and enter the next parameter.
	Run	Press this button to start inverter if keypad control is valid.
	Stop/Reset	Press this button to stop inverter if keypad control is active. In fault status, back to parameter setting status.
	Digital potentiometer	Select group number, the function code or parameter value. Clockwise rotating increase the numeric input data. Counter clockwise rotation decrease the numeric input data. Press OK is the same as ENTER
	LED	Display function setting, running monitoring, fault monitoring code and parameter.

	Frequency Indicator	On when present parameter is frequency.
	Current Indicator	On when present parameter is current.
	Voltage Indicator	On when present parameter is voltage.
	Percentage Indicator	On when present parameter is percentage.
	Forward/Reverse Indicator	On at frequency is negative. On at running is reversed
	Communication Control Indicator	On when F00.02 is set to keypad control, Off when F00.02 is set to terminal control Flickers when F00.02 is set to communication control
	Status Indicator	On when inverter is running Flickers when stopping, off after stop.
	Fault Indicator	On when inverter is in fault state.

4.2 LED Keypad Operation Mode

4 menu levels of LED keypad: Monitoring (level 0), menu mode selection (level 1), function code selection (level 2) and parameter value (level 3). In the following parts, menu levels are represented by figures.

3 parameter display modes: All menu mode (--A--) displays all function codes; user-defined mode (--U--), only displays function parameters selected by user through F11 group; non-factory defaults (--C--), only displays those function codes that are different from factory setting.

When keypad is powered, default display is the first monitoring parameter of level 0;

press **ESC** to enter menu level 1, from which using digital potentiometer to select a menu mode. The operation procedure for menu mode selection is shown in Figure 4-2.

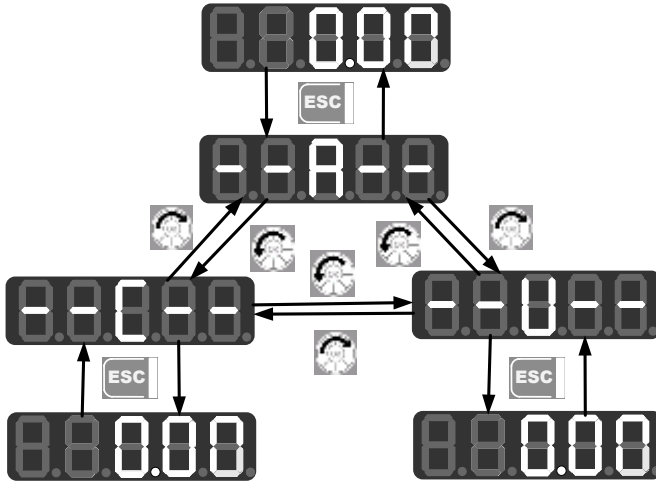

Figure 4-2 Operation Procedure of Menu Mode Selection

4.2.1 All menu mode (--A--)

Press **ENTER** under the all menu mode to enter the second level menu to select any function code. Press **ENTER** again to enter the third level menu to review or modify function parameters. Except some special function parameters, those function parameters needed by users can be modified.

Under the all menu mode, the whole operation procedure from power-on and initialization to value change of F03.28 to 5.28 is shown in Figure 4-3.

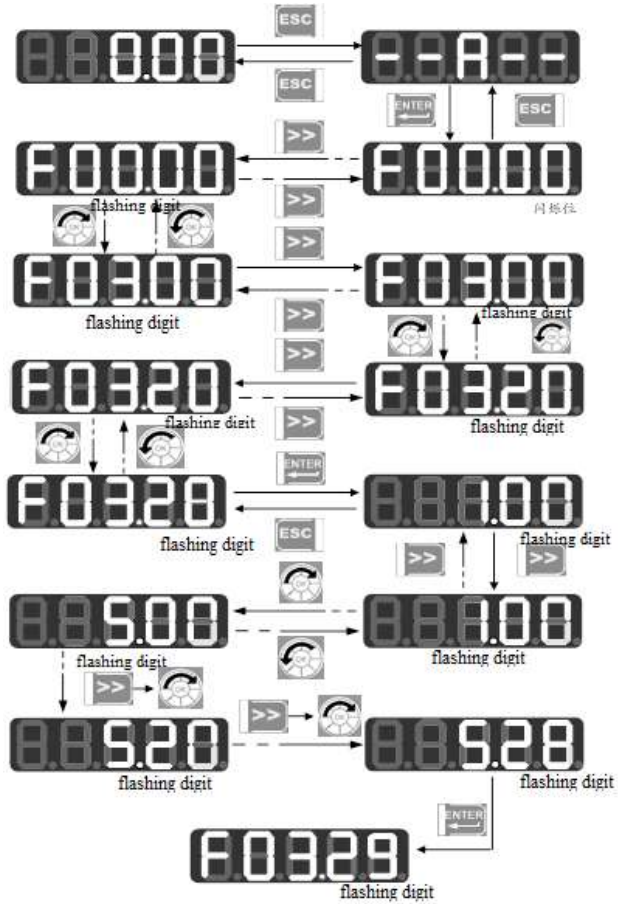



Figure 4-3 Operation Procedure from Power-on to Setting F03.28=5.28

Under all menu modes, press  to save parameter change after having changed the parameter. The difference is that after having saved the parameter: it enters the next function code under all menu modes; it enters the next user-defined function code (as per the sequence in F11.00 - F11.31) under user-defined mode; it enters the next non-factory function code under non-factory defaults mode.

Press **ESC** to cancel parameter change under the third level menu; if the function code is changed to a value as it was, it will exit the third level menu and get back to the second level menu; before completing the change, press **ESC** to cancel the change with original parameter value displayed, and press **ESC** again to exit the third level menu and return to the second level menu. See Figure 4-4 for details.

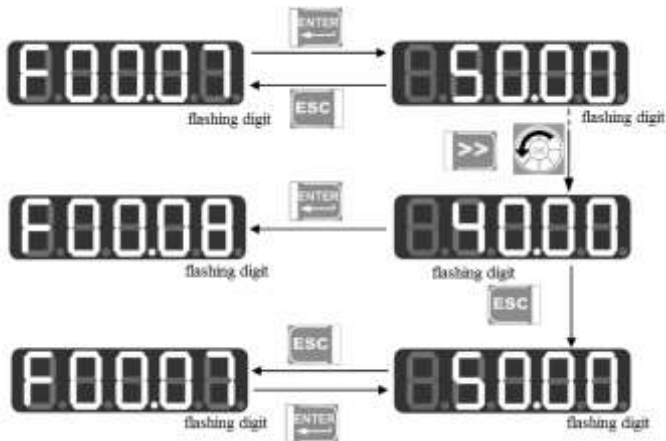

Figure 4-4 Procedure of Canceling Parameter Change by Pressing ESC

4.2.2 User-Defined Mode (--U--)

When entering function code group F11 from the all menu mode, the third level menu still displays function codes, which can be set as you please. The default display is U00.00 for the first time to enter F11.00, which means that the default function digit code of F11.00 is F00.00; at this time, the lowest cursor bit flickers and user may set any function parameter as in selecting a function code in the second level menu; press **ENTER** to save setting; when entering the user-defined mode, only corresponding function parameters will be shown.

For instance, we set F11.00 as U00.07 and set F11.01 as U00.09, i.e., F11.00 and F11.01 are respectively defined as F00.07 and F00.09. The letters U and F are used for distinguishing. U means that the function parameter is user defined. See Figure 4-5 for details.

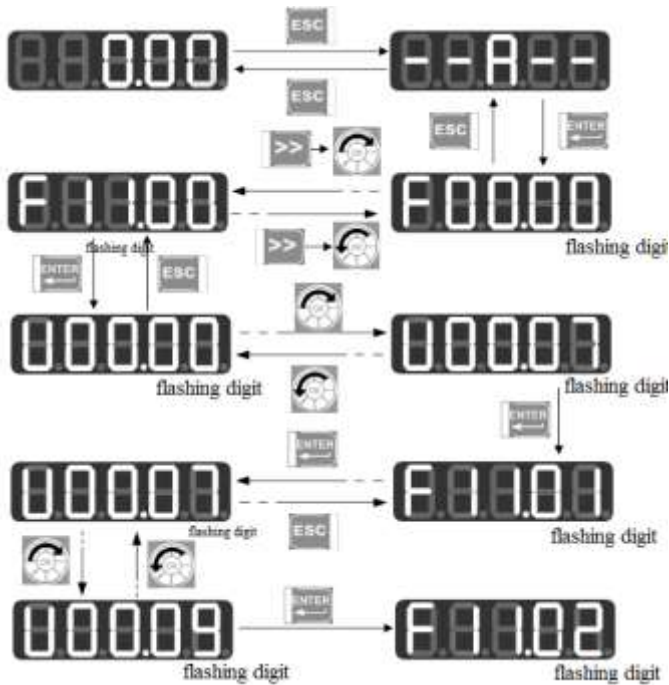



Figure 4-5 Example of User-Defined Mode Setting

Press  under the user-defined mode to enter the second level menu, which only displays 32 user-defined codes of F11. Select codes among these 32 function codes according to user needs; for those functions codes that need to be changed or viewed frequently, user may complete settings by entering F11 group under the all menu mode.

After the codes are defined in F11, we select and enter the user-defined mode again and we can see that the first function code is F00.07 defined by F11.00 and the second function code is F00.09 defined by F11.01 until F11.31. There are 32 function codes. Only 32 function parameters can be displayed by entering this mode. Changing the function parameters under the third level menu has the same effect as that under the all menu mode with the same methods. See Figure 4-6 for detail.

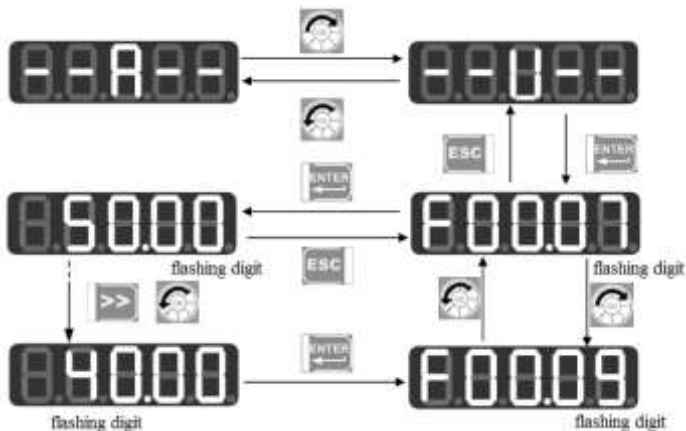

Figure 4-6 Changing Function Code under User-Defined Mode

Rotate digital potentiometer in the second level menu under the user-defined mode to switch to the parameters set by previous or next user, because user can not add or remove any function parameter of the second level menu. Switch sequence: from the function parameter defined by F11.00 to the function parameter defined by F11.31.

Press **>>** in the second level menu and cursor will not shift. After entering the third level menu by pressing **ENTER**, the lowest position of cursor will flash if current status of corresponding function code is permitted for change. The method of changing parameters is the same as that in the third level menu under all menu modes; after changing, press **ENTER** to save the change and enter the next user-defined parameter. Changing the parameter in the third level menu under different menu modes has the same effect.

4.2.3 Non-factory defaults (--C--)

Press **ENTER** under this mode to enter the second level menu, which displays the first parameter that starts from F00.00 and differs from the default setting of inverter. No shifting works by pressing **>>** under this mode; no function group or function parameter may be changed arbitrarily by rotating digital potentiometer but one

previous/next non-factory default of the function code will be displayed accordingly. The lowest position of cursor will flash if current function code is permitted for change. The method of changing parameters is the same as that in the third level menu under all menu mode; after changing, press **ENTER** to save the change and enter the next non-factory default parameter.

For instance, if we set F00.03 as 1 and set F00.07 as 40.00 under the all menu mode, which are not factory defaults, then when entering the non-factory defaults mode, the first displayed value is F00.03; clockwise rotate digital potentiometer to switch to F00.07 and counter clockwise rotate digital potentiometer to back to F00.03. The following figure will be shown:

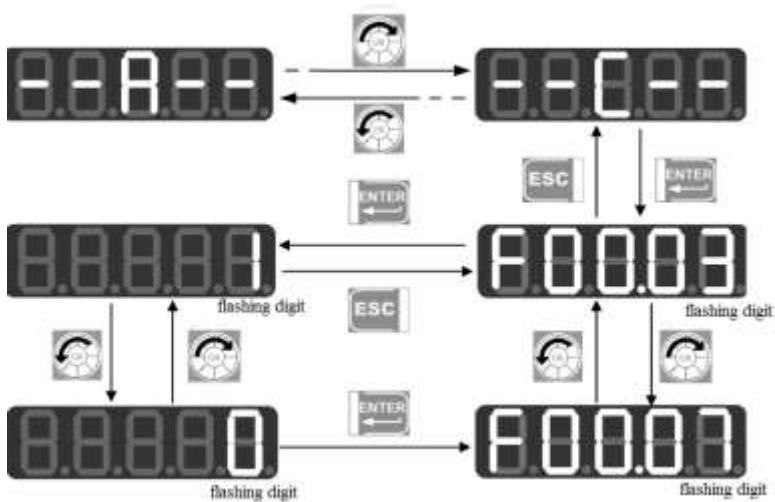



Figure 4-7 Changing Function Parameters under Non-Factory Defaults Mode

4.3 Fault Monitoring

When inverter is in fault state, press **>>** directly to switch among present fault type, fault output frequency, fault output current, fault output voltage, fault control mode and fault working time.

4.4 Operation Monitoring

There are two kinds of monitoring:

If set F12.32 as 0 it's monitoring mode 0. When the menu displayed is the level 0 monitoring menu, press  to switch the sequence of 8 monitoring parameters of each function code as per F12.04 - F12.08. If any bit of a function code is set as 1 and confirmed active, user may, through the button, display the value of corresponding monitoring parameter after returning to the monitoring menu; otherwise, if the bit is set as 0, the value of corresponding monitoring parameter will not be displayed.

If set F12.32 as 1 it's monitoring mode 1. When the menu displayed is the level 0 monitoring menu, press  to switch the sequence monitoring parameters of each function code as per F12.33 - F12.37.

4.5 Parameter Copy

Keypad can upload and download parameters, facilitating users for parameter setting in using inverters of the same function parameters. When setting the function code F12.03 as 1 and pressing  for confirmation, relevant parameters of inverter are uploaded to keypad with keypad displaying “UP” during uploading; after uploading, the function code will change to 0 automatically. Afterwards, the keypad can be inserted to other inverters that need the same parameters; set the function code F12.03 as 2 for downloading the parameters saved in keypad to inverter, with keypad displaying “DN” during downloading. After downloading, the function code will change to 0 automatically.

Special attentions are required for the following:

1. To download parameters from keypad, user must upload parameters at first. Those parameters in keypad without uploading are unknown; downloading such parameters may disorder the parameters in inverter and as a result, inverter may break down. Therefore, download parameters without parameter uploading would prompt “No DN”, which indicates that parameters are not downloaded successfully; press  to exit, and upload and then download these parameters again.

2. If inverters adopt different CPUA software versions, keypad prompts “go on” at the time of downloading parameters. Now, user needs to know whether the parameters are available for downloading at these two different versions. If available, user may press



for forced execution; if not, press





to cancel current operation. **The uploading and downloading to/from two incompatible inverters may easily cause inverters to fail for operation. Be careful!**

3. To use the function, user shall be aware that neither uploading nor downloading involves parameters of motor parameter group and after downloading, user needs to set those parameters before use.

4.6 Function of M.K.

There are multiple action modes after pressing . The default action is jog forward. When the function code (F12.00) changes the function of the button will change accordingly.

4.7 Run/Stop

Press  after setting parameters and inverter can run normally; press  to stop inverter. By changing the function code F12.00 as 5,  will be defined as coast to stop and inverter will stop running.

When the function code F01.34 is set as “autotuning” mode, it’s required to press  to make inverter enter the parameter autotuning status; “TUNE” will be shown during parameter autotuning; after completing autotuning, it will be back to the original display and the function code F01.34 will change to 0 automatically.

Motor may rotate when inverter is under rotation parameter autotuning. In case of emergency, press  to cancel the autotuning.



5. Trial Operation

5.1 Trial Operation Procedure

Follow the steps in table 5-1 for trial operation of EM500 inverter.

Table 5-1 Steps of Trial Operation

Step	Description
Installation	Check the power of inverter and install inverter as per requirements in Chapter 2.
Inverter Wiring	Wiring as per the requirements in Chapter 3.
Check before Power-on	Verify that input power is connected correctly and the input power supply circuit is already connected to the circuit breaker; inverter is grounded; the power line is connected to inverter power supply input terminals R, S and T; motor is properly connected to output terminals U, V or W of inverter; the braking resistor is connected between + and PB; the control circuit is properly connected and all limit switches and brake control terminals are connected.
Power-on Check	Check whether there is abnormal sound, foreign odor, fume or the like condition of inverter. Check whether power indicator is on and whether operation panel displays normally or there is no fault alarm. In case of abnormality, please cut the power and check it as per Chapter 9.
Parameter Setting	Setting of macros (if any).
Correctly Input Motor Nameplate Parameter	Please input the nameplate parameters of motor driven by inverter and check the input carefully, or else serious problems may occur during running. Set the parameters of motor 1 in F01 group. When two motors are used in parallel, then motor rated power (or rated current) will be sum of that of these two motors. To switch between two motors, user needs to set motor 2 parameters of F14 group
Protection Parameter Setting of Motor and	Properly set inverter and motor limit parameters and protection parameters, mainly including maximum frequency, upper limit

Inverter		<p>frequency and fault output.</p> <p>For hoisting equipment, the following protection settings shall be invalid: Current limit protection and overvoltage stall protection.</p>
Motor Parameter Autotuning		<p>Before running for the first time, please conduct motor parameter autotuning, in order to obtain the correct electrical parameters of the controlled motor.</p> <p>If motor load cannot be removed, select motor stationary autotuning (F01.34=1/11); afterwards, press  of keypad first and then press .</p> <p>If motor is still running, do not conduct motor parameter autotuning operation.</p>
Operation Control Parameter Setting	General Parameter	Correctly set rotational direction, forward/reverse control, acceleration/deceleration time, driving mode, start/stop mode, speed torque control mode and other parameters according to the working conditions of the driving system.
	V/F Control	Set function parameters including the V/F curve, stator voltage drop compensation and slip compensation, according to the load demands.
	Vector Control	Set regulator parameters according to the load.
Idling Trial Operation Check		<p>When motor is idling, start inverter at a low speed or allow it for jog running, and check and confirm the running status of driving system:</p> <p>Motor: Motor runs stably and rotates normally and correctly; the acceleration/deceleration process is normal, free of abnormal vibration, noise and foreign odor.</p> <p>Inverter: Operation panel displays data normally, fan rotates normally and relay acts normally, free from vibration and foreign odor.</p> <p>In case of abnormal condition, immediately stop it and cut the power for checking.</p>
On-Load Trial Operation Check		Conduct on-load trial operation check only after inverter has passed no-load operation check satisfactorily, .

		<p>In case of ramp-to-stop, please confirm braking unit and braking resistor have been properly connected.</p> <p>Check whether inverter runs normally and whether braking mechanism acts normally by switching forward and reverse operations with keypad.</p> <p>Observe whether inverter outputs corresponding frequency level by level through master controller's sending of speed signal of all speed levels.</p> <p>Independent braking unit. Please observe whether the braking unit indicator is on.</p>
Normal Operation	Basic Operation	<p>Inverter can start, run, stop, run forward and reverse, and perform other basic operations. In case of any abnormality, please check whether input and start/stop function codes are correctly set.</p>
	Performance Setting	<p>S Curve Acceleration/Deceleration</p> <p>Often used for occasions of high-inertia drive system and occasions sensitive to acceleration to reduce mechanic shock and avoid system vibration.</p>
		<p>DC Braking</p> <p>Input DC current to motor before start or stop, in order to generate braking torque and thus rapidly stop the rotating motor.</p>
		<p>Special Terminal Control</p> <p>With multiple multi-function input and output ports, EM500 can offer various kinds of application solution when in use with external controller.</p>



1. It's strongly recommended to execute the trial operation with keypad under terminal or communication control application.

2. Inverter can be used normally only after it has passed the idle trial operation and the full-load trial operation.

5.2 Attentions for Trial Operation

5.2.1 Turn on the Power Switch

Before turning on the power switch, please confirm the following items:

- Correct power voltage: 3-phase AC380 - 415V or 3-phase/single-phase AC220 – 230V, 50Hz

- Input power cable is connected to inverter's input terminals R, S and T.
- Inverter's output terminals U, V and W are connected to motor's input terminals.
- Control circuit terminals are correctly connected to the control devices and terminals are disconnected.
- The load motor is idle.
- Turn on the power switch when the settings above are correct.
- \oplus \ominus are output ends of inverter's DC bus voltage; \oplus represents the protective grounding terminal and PB represents cable end of braking resistor. Damages of inverter caused by incorrect wiring of them are not covered in the warranty.

5.2.2 Confirm the Power-on Status

If inverter works normally after power-on, keypad will display inverter's present status code and parameters. In case of other abnormal display phenomena, see Chapter 9 Troubleshooting.

- Running status observation:
 1. Check whether load runs at a correct direction.
 2. At low-speed running, increase the set frequency only when load machine stabilizes.
 3. Change input frequency or rotational speed and observe whether motor has any vibration or noise.
 4. During operation, observe the parameters of monitoring code F18.06 and confirm whether inverter output current is normal.

6. Function Code Table

6.1 Parameter Description

EM500 inverter has 24 groups of function codes as shown in Table 6–1, each group having multiple function codes. F18 is a monitoring parameter group and used for viewing inverter status; F19 is a fault record group and used for viewing three latest faults; other groups are parameter setting groups and used for setting different functions.

Table 6–1 Introduction of Parameters

F00	Basic Function Parameter Group	F01	Motor 1 Parameter
F02	Input Terminal Function Group	F03	Output Terminal Function Group
F04	Start/Stop Control Parameter Group	F05	V/F Control Parameter Group
F06	Vector Control Parameter Group	F07	Protection Function Setting Group
F08	Preset Speed and Simple PLC	F09	PID Function Group
F10	Communication Function Group	F11	User-Defined Parameter Group
F12	Keypad and Display Function Group	F13	Torque Control Parameter Group
F14	Motor 2 Parameter Group	F15	Auxiliary Function Group
F16	Customized Function Group	F17	Virtual I/O Function Group
F18	Monitoring Parameter Group	F19	Fault Record Group
F25	Application of water supply basic groups	F26	Application of water supply advanced group
F27	Winding Applications Parameter Group	F28	Air compressor Applications Parameter Group

★ Note: If some parameters of EM500 are not used, 0 is returned after read; if user retains some options of some parameters, these options can be set, but may result in abnormal running of inverter. Please prevent incorrect operation of these parameters.

The table below describes all items of the function code table:

No.	F00.00 - F99.99: Numbering of function codes	
Function	Complete names of function codes. “Not Used” means that this function code will be retained temporarily, without actual meaning.	
Range	Brief Parameter Description.	
	Overall	The value of the whole function code represents present parameter selection or meaning.

	Decimal Digit	Represents some options or present meaning of present function code.				
	Binary digit	Each binary digit represents some options or present meaning of present function codes				
Unit	Metric unit of function codes. Their units and abbreviations are as follows:					
	Hz	Hertz	kW	Kilowatt	us	Microsecond
	kHz	Kilohertz	kWh	Kilowatt-hour★	ms	Millisecond
	%	Percentage★	M□h	Megawatt hour	s	Second
	V	Volt	mΩ	Milliohm	min	Minute
	A	Ampere	mH	Millihenry	h	Hour
	rpm	Revolutions per minute	°C	Degree Celsius	m	Meter
★ %: Its benchmarks are different depending upon different physical quantity; kWh: kilowatt-hour.						
Default	Factory defaults of function codes or reset to the defaults (F12.14=1).					
	In figures (for example 50.00)	For various power segments, present values of the function codes are the default values.				
	Model	For different power segments, the function codes have different defaults.				
	XXX	For different power segments or batches, the function codes have different defaults.				
Type	Property change of function codes (whether change is permitted and conditions for change)					
	●	Can be changed while inverter is running; present function code can be changed regardless of the status of inverter.				
	○	Cannot be changed while inverter is running; present function code can be changed except the running status.				
	×	Read only: the property of present function code can not be changed under any status.				

6.2 Function Parameter Table

No.	Function	Range	Unit	Default	Type
F00	Basic Function Parameter Group				

EM500 Open-Loop Vector Control Inverter User Manual

F00.00	Not Used				
F00.01	Drive Control Mode of Motor 1	0: V/F control (VVF) 1: Sensorless Vector Control (SVC)		0	○
F00.02	Command Source Options	0: Keypad Control (LOC/REM indicator on) 1: Terminal Control (LOC/REM indicator off) 2: Communication Control (LOC/REM indicator flickers)		0	○
F00.03	Terminal Control Mode Options	0: Terminal RUN for running, Forward/Reverse (F/R) 1: Terminal RUN for forward, F/R reverse 2: Terminal RUN for forward, Xi stop, F/R reverse 3: Terminal RUN for running, Xi stop Forward/Reverse (F/R)		0	○
F00.04	Main Frequency Source A Options	0: Numeric Frequency Setting F00.07 1: AI1 2: AI2 3: AI3 4: AI4 (Expansion Card) 5: High-Frequency Pulse Input (X7) 6: Main Frequency Communication Percentage Setting 7: Main Frequency Communication Direct Setting 8: digital Potentiometer		0	○
F00.05	Auxiliary Frequency Source B Options	0: Numeric Frequency Setting F00.07 1: AI1 2: AI2 3: AI3 4: AI4 (Expansion Card) 5: High-Frequency Pulse Input (X7) 6: Auxiliary Frequency Communication Setting 7: Auxiliary Frequency Communication Direct Setting 8: digital Potentiometer 9: Not Used		0	○

EM500 Open-Loop Vector Control Inverter User Manual

		10: Process PID 11: Simple PLC			
F00.06	Frequency Source Options	0: Main Frequency Source A 1: Auxiliary Frequency Source B 2: Main and Auxiliary Arithmetic Results 3: Switching between Main Frequency Source A and Auxiliary Frequency Source B 4: Switching between Main Frequency Source A and Main & Auxiliary Arithmetic Results 5: Switching between Auxiliary Frequency Source B and Main & Auxiliary Arithmetic Results 6: Auxiliary Frequency Source B+ Feedforward arithmetic (Winding application)		0	○
F00.07	Numeric Frequency Setting	0.00 Hz - Maximum Frequency F00.16	Hz	50.00	●
F00.08	Main and Auxiliary Arithmetic	0: Main Frequency Source A + Auxiliary Frequency Source B 1: Main Frequency Source A - Auxiliary Frequency Source B 2: The Bigger of Main A and Auxiliary B 3: The Smaller of Main A and Auxiliary B		0	○
F00.09	Reference Option for Auxiliary Frequency Source B at Main and Auxiliary Arithmetic	0: Relative to Maximum Frequency 1: Relative to Main Frequency Source A		0	○
F00.10	Main Frequency Source Gain	0.0 - 300.0	%	100.0	●
F00.11	Auxiliary Frequency Source Gain	0.0 - 300.0	%	100.0	●
F00.12	Synthetic Gain of Main and Auxiliary Frequency	0.0 - 300.0	%	100.0	●
F00.13	Analog Adjustment	0: Synthetic Frequency of Main and		0	○

EM500 Open-Loop Vector Control Inverter User Manual

	of Synthetic Frequency	Auxiliary Channels 1: AI1 * Synthetic Frequency of Main and Auxiliary Channels 2: AI2 * Synthetic Frequency of Main and Auxiliary Channels 3: AI3 * Synthetic Frequency of Main and Auxiliary Channels 4: AI4 * Synthetic Frequency of Main and Auxiliary Channels 5: High-Frequency Pulse (PULSE) * Synthetic Frequency of Main and Auxiliary Channels			
F00.14	Acceleration Time 1	0.00 - 650.00 (F15.13=0) 0.0 - 6500.0 (F15.13=1) 0 - 65000 (F15.13=2)	s	15.00	●
F00.15	Deceleration Time 1	0.00 - 650.00 (F15.13=0) 0.0 - 6500.0 (F15.13=1) 0 - 65000 (F15.13=2)	s	15.00	●
F00.16	Maximum Frequency	1.00 - 600.00	Hz	50.00	○
F00.17	Upper Limit Frequency Control Options	0: Set through F00.18 1: AI1 2: AI2 3: AI3 4: AI4 (Expansion Card) 5: High-Frequency Pulse Input (X7) 6: Upper Limit Frequency Communication Percentage Setting 7: Upper Limit Frequency Communication Direct Setting		0	○
F00.18	Upper Limit Frequency	Lower Limit Frequency F00.19 - Maximum Frequency F00.16	Hz	50.00	●
F00.19	Lower Limit Frequency	0.00 - Upper Limit Frequency F00.18	Hz	0.00	●
F00.20	Running Direction	0: Same 1: Opposite		0	●
F00.21	Reverse Control	0: Permit Forward/Reverse 1: Prohibit Reverse		0	○
F00.22	F/R Deadband Time	0.00 - 650.00	s	0.00	●
F00.23	Carrier Frequency	1.0 - 16.0 (inverter rated power 0,75 –	kHz	4.0	●

		4.00kW) 1.0 - 10.0 (inverter rated power 5.50 - 7.50 kW) 1.0 - 8.0 (inverter rated power 11.00 – 45.00 kW) 1.0 - 4.0 (inverter rated power 55.00 – 90.00 kW) 1.0 - 3.0 (inverter rated power 110.00 – 560.00 kW)		(7.5kW and the following g2.0	
F00.24	Automatic Adjustment of Carrier Wave	0: Disabled 1: Enabled 1 2: Enabled 2		1	○
F00.25	Carrier Frequency Noise Suppression	0: Disabled 1: Enabled		0	○
F00.26	Noise Suppression Tone	20 - 200	Hz	40	●
F00.27	Noise Suppression Intensity	10 - 150	Hz	100	●
F00.28	Motor Parameter Group Options	0: Motor 1 Parameter 1: Motor 2 Parameter		0	○
F00.29	User Password	0 - 65535		0	○
F00.30	Inverter Type	0: G 1: P		0	○
F00.31	Frequency resolution	0: 0.01Hz 1: 0.1Hz			
F01	Motor 1 Parameter				
F01.00	Motor Type	0: Common Induction Motor 1: Inverter Induction Motor 2: Permanent Magnet Synchronous Motor		0	○
F01.01	Motor Rated Power	0.10 - 650.00	kW	Up To Specific Model	○
F01.02	Motor Rated Voltage	50 - 2000	V	Up To Specific Model	○
F01.03	Motor Rated Current	0.01 - 600.00 (Motor Rated Power ≤ 75 kW) 0.1 - 6000.0 (Motor Rated Power >75 kW)	A	Up To Specific Model	○

EM500 Open-Loop Vector Control Inverter User Manual

F01.04	Motor Rated Frequency	0.01 - 600.00	Hz	Up To Specific Model	○
F01.05	Motor Rated Speed	1 - 60000	rpm	Up To Specific Model	○
F01.06	Motor Winding Connection	0: Y 1: Δ		Up To Specific Model	○
F01.07	Motor Rated Power Factor	0.600 - 1.000		Up To Specific Model	○
F01.08	Motor Efficiency	30.0 - 100.0	%	Up To Specific Model	○
F01.09	Stator Resistor of Induction Motor	1 - 60000 (Motor Rated Power ≤ 75kW) 0.1 - 6000.0 (Motor Rated Power >75kW)	mΩ	Up To Specific Model	○
F01.10	Rotor Resistor of Induction Motor	1 - 60000 (Motor Rated Power ≤ 75kW) 0.1 - 6000.0 (Motor Rated Power >75kW)	mΩ	Up To Specific Model	○
F01.11	Leakage Inductance of Induction Motor	0.01 - 600.00 (Motor Rated Power ≤ 75kW) 0.01 - 60.000 (Motor Rated Power >75kW)	mH	Up To Specific Model	○
F01.12	Mutual Inductance of Induction Motor	0.1 - 6000.0 (Motor Rated Power ≤ 75kW) 0.01 - 600.00 (Motor Rated Power >75kW)	mH	Up To Specific Model	○
F01.13	Idling Excitation Current of Induction Motor	0.01 - 600.00 (Motor Rated Power ≤ 75kW) 0.1 - 6000.0 (Motor Rated Power >75kW)	A	Up To Specific Model	○
F01.14	Induction Motor Field Weakening Factor 1	10.00 - 100.00	%	87.00	○
F01.15	Induction Motor Field Weakening Factor 2	10.00 - 100.00	%	80.00	○
F01.16	Induction Motor	10.00 - 100.00	%	75.00	○

EM500 Open-Loop Vector Control Inverter User Manual

	Field Weakening Factor 3				
F01.17	Induction Motor Field Weakening Factor 4	10.00 - 100.00	%	72.00	○
F01.18	Induction Motor Field Weakening Factor 5	10.00 - 100.00	%	70.00	○
F01.19	Stator Resistor of Synchronous Motor	1 - 60000 (Motor Rated Power ≤ 75kW) 0.1 - 6000.0 (Motor Rated Power >75kW)	mΩ	Up To Specific Model	○
F01.20	d-Shaft Inductance of Synchronous Motor	0.01 - 600.00 (Motor Rated Power ≤ 75kW) 0.001 - 60.000 (Motor Rated Power >75kW)	mH	Up To Specific Model	○
F01.21	q-Shaft Inductance of Synchronous Motor	0.01 - 600.00 (Motor Rated Power ≤ 75kW) 0.001 - 60.000 (Motor Rated Power >75kW)	mH	Up To Specific Model	○
F01.22	Counter Electromotive Force of Synchronous Motor	10.0 - 2000.0 (Counter Electromotive Force of Rated Rotation Speed)	V	Up To Specific Model	○
F01.23	Initial Electric Angle of Synchronous Motor	0.0 - 359.9 (Synchronous motor enabled)			○
F01.24 - F01.33	Not Used				
F01.34	Motor Parameter Autotuning	0: No Autotuning 1: Stationary Autotuning of Induction Motor 2: Rotational Autotuning of Induction Motor 11: Stationary Autotuning of Synchronous Motor 12: Rotational Autotuning of Synchronous Motor		0	○
F02	Input Terminal Function Group				

EM500 Open-Loop Vector Control Inverter User Manual

F02.00	X1 Numeric Input Function	0: No Function	1	○
F02.01	X2 Numeric Input Function	1: Run Terminal “RUN” 2: Direction R/F	2	○
F02.02	X3 Numeric Input Function	3: 3-Wire Sequence Stop Control 4: Forward JOG (FJOG)	11	○
F02.03	X4 Numeric Input Function	5: Reverse JOG (RJOG) 6: Terminal UP	12	○
F02.04	X5 Numeric Input Function	7: Terminal DOWN 8: Clear UP/Down Offset	13	○
F02.05	X6 Numeric Input Function	9: Coast to Stop 10: Fault Reset	14	○
F02.06	X7 Numeric Input Function	11: Preset Speed Terminal 1 12: Preset Speed Terminal 2	10	○
F02.07	AI1 Numeric Input Function	13: Preset Speed Terminal 3 14: Preset Speed Terminal 4	0	○
F02.08	AI2 Numeric Input Function	15: Preset PID Terminal 1 16: Preset PID Terminal 2	0	○
F02.09	AI3 Numeric Input Function	17: Preset Torque Terminal 1 18: Preset Torque Terminal 2	0	○
F02.10	AI4 Numeric Input Function (Expansion Card)	19: Acceleration/Deceleration Time Terminal 1 20: Acceleration/Deceleration Time Terminal 2	0	○
F02.11	X8 Numeric Input Function (Expansion Card)	21: Acceleration/Deceleration Time Terminal Disabled 22: Operation Pause	0	○
F02.12	X9 Numeric Input Function (Expansion Card)	23: External Fault Input 24: Switch Run Command to Keypad	0	○
F02.13	X10 Numeric Input Function (Expansion Card)	25: Switch Run Command to Communication 26: Frequency Source Switching	0	○
F02.14	X11 Numeric Input Function (Expansion Card)	27: Clear Timed Running time 28: Switch between Speed Control and Torque Control	0	○
		29: Torque Control Disabled 30: Switch between Motor 1 and Motor 2 31: Simple PLC Status Reset (Start to Run with Preset Speed 1, Clear Running time) 32: Simple PLC Time Pause (Keep		

	<p>Running at Present Speed) 33: Not Used 34: Count Input ($\leq 250\text{Hz}$) 35: High-Speed Count Input ($\leq 100\text{kHz}$, Only Enabled for X7) 36: Counter Clear 37: Length Count Input ($\leq 250\text{Hz}$) 38: High-Speed Length Count Input ($\leq 100\text{kHz}$, Only Enabled for X7) 39: Length Clear 40: Pulse Input ($\leq 100\text{kHz}$, Only Enabled for X7) 41: Process PID Pause 42: Process PID Integral Pause 43: PID Parameter Switch 44: PID Positive/Negative Action Switch 45: Stop and DC Brake 46: DC Brake at Stop 47: Immediate DC Brake 48: Fastest Coast-To-Stop 49: Not Used 50: External Stop 51: Switch Main Frequency Source to Numeric Frequency Setting 52: Switch Main Frequency Source to AI1 53: Switch Main Frequency Source to AI2 54: Switch Main Frequency Source to AI3 55: Switch Main Frequency Source to High-Frequency Pulse Input 56: Switch Main Frequency Source to Communication Setting 57: Inverter Enabled 58-78: Not Used 79: Remote Start 80: Power Frequency Conversion 81-88: Not Used 89: Feedforward Reset</p>	
--	--	--

		90-103: Not Used 104: Inlet Pool Upper Limit Water Level Signal 105: Inlet Pool Lower Limit Water Level Signal 106: Inlet Pool Lack Of Water Level Signal 107: Sewage Pool Upper Limit Water Level Signal 108: Sewage Pool Lower Limit Water Level Signal 109: Not Used 110: External Overpressure Signal 111: Not Used 112: Switch The Pump 113~120: Not Used 121: External Signals Of Material supply disruptions 122: Winding traverse Detection Signal 123: Braking Reset Terminals										
F02.15	Positive/Negative Logic 1 of Numeric Input Terminal	D7	D6	D5	D4	D3	D2	D1	D0		*00 00000	○
		*	X7	X6	X5	X4	X3	X2	X1			
		0: Positive Logic, Enabled at On/Disabled at Off 1: Negative Logic, Disabled at On/Enabled at Off										
F02.16	Positive/Negative Logic 2 of Numeric Input Terminal	D7	D6	D5	D4	D3	D2	D1	D0		000 00000	○
		X11	X10	X9	X8	A14	A13	A12	A11			
		0: Positive Logic, Enabled at On/Disabled at Off 1: Negative Logic, Disabled at On/Enabled at Off										
F02.17	Filter Times of Numeric Input Terminal	0-100, 0 for No Filter, n for sampling once every n ms								2	○	
F02.18	X1 Effective Delay Time	0.000 - 30.000								s	0.000	●
F02.19	X1 Ineffective Delay Time	0.000 - 30.000								s	0.000	●
F02.20	X2 Effective Delay	0.000 - 30.000								s	0.000	●

EM500 Open-Loop Vector Control Inverter User Manual

	Time				
F02.21	X2 Ineffective Delay Time	0.000 - 30.000	s	0.000	●
F02.22	X3 Effective Delay Time	0.000 - 30.000	s	0.000	●
F02.23	X3 Ineffective Delay Time	0.000 - 30.000	s	0.000	●
F02.24	X4 Effective Delay Time	0.000 - 30.000	s	0.000	●
F02.25	X4 Ineffective Delay Time	0.000 - 30.000	s	0.000	●
F02.26	Minimum Input Pulse Frequency	0.00 – Maximum Input Pulse Frequency F02.28	kHz	0.00	●
F02.27	Setting Corresponding to Minimum Input	-100.0 - +100.0	%	0.0	●
F02.28	Maximum Input Pulse Frequency	0.01 - 100.00	kHz	50.00	●
F02.29	Setting Corresponding to Maximum Input	-100.0 - +100.0	%	100.0	●
F02.30	Pulse Input Filter Time	0.00 - 10.00	s	0.10	●
F02.31	Analog Input Function	<p>Ones Place: AI1 0: Analog Input 1: Numeric Input (0 for less than 1V, 1 for over 3V, contrary to the last time for 1V-3V)</p> <p>Tens Place: AI2 0: Analog Input 1: Numeric input (the same as above)</p> <p>Hundreds Place: AI3 0: Analog Input 1: Numeric input (the same as above)</p> <p>Thousands Place: AI4 (Expansion Card) 0: Analog Input 1: Numeric input (the same as above)</p>		0000D	○

F02.32	Analog Input Curve Options	<p>Ones Place: AI1 Curve 0: Curve 1 1: Curve 2 2: Curve 3 3: Curve 4</p> <p>Tens Place: AI2 Curve 0: Curve 1 1: Curve 2 2: Curve 3 3: Curve 4</p> <p>Hundreds Place: AI3 Curve 0: Curve 1 1: Curve 2 2: Curve 3 3: Curve 4</p> <p>Thousands Place: AI4 Curve 0: Curve 1 1: Curve 2 2: Curve 3 3: Curve 4</p>		3210D	○
F02.33	Minimum Input of Curve 1	0.00 - F02.35	V	0.10	●
F02.34	Setting Corresponding to Minimum Input of Curve 1	-100.0 - +100.0	%	0.0	●
F02.35	Maximum Input of Curve 1	F02.33 - 10.00	V	9.90	●
F02.36	Setting Corresponding to Maximum Input of Curve 1	-100.0 - +100.0	%	100.0	●
F02.37	Minimum Input of Curve 2	-10.00 - F02.39	V	0.10	●
F02.38	Setting Corresponding to Minimum Input of Curve 2	-100.0 - +100.0	%	0.0	●
F02.39	Maximum Input of Curve 2	F02.37 - 10.00	V	9.90	●

F02.40	Setting Corresponding to Maximum Input of Curve 2	-100.0 - +100.0	%	100.0	●
F02.41	Minimum Input of Curve 3	0.00 - F02.43	V	0.10	●
F02.42	Setting Corresponding to Minimum Input of Curve 3	-100.0 - +100.0	%	0.0	●
F02.43	Input of Inflexion 1 of Curve 3	F02.41 - F02.45	V	2.50	●
F02.44	Setting Corresponding to Input of Inflexion 1 of Curve 3	-100.0 - +100.0	%	25.0	●
F02.45	Input of Inflexion 2 of Curve 3	F02.43 - F02.47	V	7.50	●
F02.46	Setting Corresponding to Input of Inflexion 2 of Curve 3	-100.0 - +100.0	%	75.0	●
F02.47	Maximum Input of Curve 3	F02.45 - 10.00	V	9.90	●
F02.48	Setting Corresponding to Maximum Input of Curve 3	-100.0 - +100.0	%	100.0	●
F02.49	Minimum Input of Curve 4	-10.00 - F02.51	V	-9.90	●
F02.50	Setting Corresponding to Minimum Input of Curve 4	-100.0 - +100.0	%	-100.0	●
F02.51	Input of Inflexion 1 of Curve 4	F02.49 - F02.53	V	-5.00	●
F02.52	Setting Corresponding to Input of Inflexion 1 of Curve 4	-100.0 - +100.0	%	-50.0	●

EM500 Open-Loop Vector Control Inverter User Manual

F02.53	Input of Inflexion 2 of Curve 4	F02.51 - F02.55	V	5.00	●	
F02.54	Setting Corresponding to Input of Inflexion 2 of Curve 4	-100.0 - +100.0	%	50.0	●	
F02.55	Maximum Input of Curve 4	F02.53 - 10.00	V	9.90	●	
F02.56	Setting Corresponding to Maximum Input of Curve 4	-100.0 - +100.0	%	100.0	●	
F02.57	A11 Filter Time	0.00 - 10.00	s	0.10	●	
F02.58	A12 Filter Time	0.00 - 10.00	s	0.10	●	
F02.59	A13 Filter Time	0.00 - 10.00	s	0.10	●	
F02.60	A14 Filter Time (Expansion Card)	0.00 - 10.00	s	0.10	●	
F02.61	AD Sampling Hysteresis	2 - 50		2	○	
F03	Output Terminal Function Group					
F03.00	Y1 Output Function	0: No Output 1: Inverter Running (RUN) 2: Frequency Reach Range (FAR) 3: Output Frequency Detection Range FDT1 4: Output Frequency Detection Range FDT2 5: Reverse running (REV) 6: Jogging 7: Inverter Fault 8: Inverter Ready 9: Upper Limit Frequency Reach 10: Lower Limit Frequency Reach 11: Current Limit Enabled 12: Overvoltage Stall Enabled 13: Simple PLC Cycle Finished 14: Set Count Value Reach 15: Designated Count Value Reach 16: Length Reach 17: Motor Overload Pre-alariming		1	○	
F03.01	Y2 Output Function			3	○	
F03.02	R1 Output Function (EA-EB-EC)			7	○	
F03.03	R2 Output Function (RA-RB-RC)			8	○	
F03.04	Y3 Output Function (expansion card)			0	○	

		18: Inverter Overheating Pre-Alarming 19: PID Feedback Upper Limit Reach 20: PID Feedback Lower Limit Reach 21: Analog input Level Detection ADT1 22: Analog input Level Detection ADT2 23: Not Used 24: Undervoltage Status 25: Motor Overheating Pre-alarmed 26: Set Time Reach 27: Run at Zero Speed 28-48: Not Used 38: Off Loading 49: Inlet Valve Control 50: Fan Start-stop Control Signals 51: Phase Angle Arrival 52: Inverter Startup Is Completed 53: Switch to Power frequency 54-55: Not Used 56: Pipeline Overpressure Alarm 57: Under-voltage Alarm 58: Water Shortage Alarm 59: Dormancy Instructions 60: Pump Rotation Instructions 61: The Standby Pressure Operation Instructions 62: Not Used 63: H Pump Control 64: I pump control 65-66: Not Used 67: Brake Control 68: Material supply disruptions Detection Output 69: FDT1 Lower Bound (Pulse) 70: FDT2 Lower Bound (Pulse) 71: FDT1 Lower Bound (Pulse JOG Is Invalid) 72: FDT1 Lower Bound (Pulse JOG Is Invalid)										
F03.05	Output Signal Type	D7	D6	D5	D4	D3	D2	D1	D0		0000	○
		*	*	*	*	R2	R1	Y2	Y1			
		0: Level										

EM500 Open-Loop Vector Control Inverter User Manual

		1: Monopulse										
F03.06	Positive/Negative Logic of Numeric Output	D7	D6	D5	D4	D3	D2	D1	D0		00000	○
		*	*	*	Y3	R2	R1	Y2	Y1			
		0: Positive Logic, Enabled at On/Disabled at Off 1: Negative Logic, Disabled at On/Enabled at Off										
F03.07	Y2 Output Type	0: Common Numeric Output 1: High-Frequency Pulse Output									0	○
F03.08	Output Status Control at JOG	D7	D6	D5	D4	D3	D2	D1	D0		00000	○
		*	*	*	REV	FDT2	FDT1	FAR	RUN			
		0: Enabled at JOG 1: Disabled at JOG										
F03.09	Y1 Effective Delay Time	0.000 - 30.000								s	0.000	●
F03.10	Y1 Ineffective Delay Time	0.000 - 30.000								s	0.000	●
F03.11	Y2 Effective Delay Time	0.000 - 30.000								s	0.000	●
F03.12	Y2 Ineffective Delay Time	0.000 - 30.000								s	0.000	●
F03.13	R1 Effective Delay Time	0.000 - 30.000								s	0.000	●
F03.14	R1 Ineffective Delay Time	0.000 - 30.000								s	0.000	●
F03.15	R2 Effective Delay Time	0.000 - 30.000								s	0.000	●
F03.16	R2 Ineffective Delay Time	0.000 - 30.000								s	0.000	●
F03.17	Y1 Monopulse Output Time	0.001 - 30.000								s	0.250	●
F03.18	Y2 Monopulse Output Time	0.001 - 30.000								s	0.250	●
F03.19	R1 Monopulse Output Time	0.001 - 30.000								s	0.250	●
F03.20	R2 Monopulse Output Time	0.001 - 30.000								s	0.250	●
F03.21	Analog Output M1	0: Running Frequency (absolute value)									0	○
F03.22	Analog Output M2	1: Set Frequency (absolute value)									2	○
F03.23	Y2 High-Frequency	2: Output torque (absolute value)									11	○

EM500 Open-Loop Vector Control Inverter User Manual

	Pulse Output Function	3: Set Torque (absolute value) 4: Output Current 5: Output Voltage 6: Bus voltage 7: Output power 8: AI1 9: AI2 10: AI3 11: AI4 (Expansion Card) 12: High-Frequency Pulse Input (100.00% Corresponding to Maximum Frequency, 0.00% Corresponding to Minimum Frequency) 13: Not Used 14: The Count Value 15: Length Value 16: The PID Output Percentage 18: PID Feedback 19: PID Given 20~37: Not Used 38: The Fan Speed Output			
F03.24	100% Frequency of Y2 High-Frequency Pulse Output	0.00 - 100.00	kHz	50.00	●
F03.25	0% Frequency of Y2 High-Frequency Pulse Output	0.00 - 100.00	kHz	0.00	●
F03.26	Filter Time of Y2 High-Frequency Pulse Output	0.00 - 10.00	s	0.10	●
F03.27	M1 Output Offset	-100.0 - 100.0	%	0.0	●
F03.28	M1 Output Gain	-10.00 - 10.00		1.00	●
F03.29	M2 Output Offset	-100.0 - 100.0	%	0.0	●
F03.30	M2 Output Gain	-10.00 - 10.00		1.00	●
F04	Start/Stop Control Parameter Group				
F04.00	Start Mode	0: Start Directly 1: Rotation Speed Tracking Start		0	○
F04.01	Start Frequency	0.00 - 10.00	Hz	0.00	○
F04.02	Start Frequency Retention Time	0.00 - 60.00, Disabled at 0.00	s	0.00	○

EM500 Open-Loop Vector Control Inverter User Manual

F04.03	DC Brake Current at Start	0.0 - 100.0 (100.0= Motor Rated Frequency)	%	100.0	○
F04.04	DC Brake Time at Start	0.00 - 30.00	s	0.00	○
F04.05	Not Used				
F04.06	Pre-Excitation Current	50.0 - 500.0 (100.0=Idling Current)	%	100.0	○
F04.07	Pre-Excitation Time	0.00 - 10.00	s	0.10	○
F04.08	Rotation Speed Tracking Method	0: Start from Maximum Frequency 1: Start from Stop Frequency 2: Start from Power frequency		0	○
F04.09	Rise Time of Rotation Speed Tracking Voltage	0.05 - 10.00	s	0.30	○
F04.10	Deceleration Time of Rotation Speed Tracking	0.1 - 20.0	s	2.0	○
F04.11	Rotation Speed Tracking Current	30.0 - 150.0 (100.0=Inverter Rated Current)	%	60.0	●
F04.12	Rotation Speed Tracking Compensation Gain	1.00 - 1.30		1.05	●
F04.13	Not Used				
F04.14	Acceleration/Deceleration Mode	0: Linear Acceleration/Deceleration 1: S Curve Acceleration/Deceleration		0	○
F04.15	S Curve Start Section Time at Acceleration	0.00 - System acceleration time/2 (F15.13=0) 0.0 - System acceleration time/2 (F15.13=1) 0 - System acceleration time/2 (F15.13=2)	s	1.00	●
F04.16	S Curve End Section Time at Acceleration	0.00 - System acceleration time/2 (F15.13=0) 0.0 - System acceleration time/2 (F15.13=1) 0 - System acceleration time/2 (F15.13=2)	s	1.00	●
F04.17	S Curve Start Section Time at Deceleration	0.00 - System deceleration time/2 (F15.13=0) 0.0 - System deceleration time/2 (F15.13=1) 0 - System deceleration time/2 (F15.13=2)	s	1.00	●

EM500 Open-Loop Vector Control Inverter User Manual

F04.18	S Curve End Section Time at Deceleration	0.00 - System deceleration time/2 (F15.13=0) 0.0 - System deceleration time/2 (F15.13=1) 0 - System deceleration time/2 (F15.13=2)	s	1.00	●
F04.19	Stop Mode	0: Ramp-To-Stop 1: Coast-to-Stop		0	○
F04.20	DC Brake Start Frequency at Stop	0.00 - Maximum Frequency F00.16	Hz	0.00	○
F04.21	DC Brake Current at Stop	0.0 - 150.0 (100.0= Motor Rated Current)	%	100.0	○
F04.22	DC Brake Time at Stop	0.00 - 30.00, Disabled at 0.00	s	0.00	○
F04.23	DC Brake Field Weakening Time at Stop	0.00 - 30.00	s	0.50	○
F04.24	Magnetic Flux Brake Gain	100 – 150 (100: No Magnetic Flux Brake)		100	○
F04.25	Not Used				
F04.26	Start Mode after Fault/Coast to Stop	0: Start as per Set Mode of F04.00 1: Rotation Speed Tracking Start		0	○
F04.27	Terminal Start Command Reconfirmation	0: Not to Confirm 1: Confirm		0	○
F04.28	Not Used				
F04.29	Zero speed frequency	0.00 – 5.00	Hz	0.25	●
F04.30	Initial Position Search after Power-on or Fault	0: Disabled 1: Enabled		0	●
F05	V/F Control Parameter Group				
F05.00	V/F Curve Setting	0: Straight Line V/F 1: Multi-Dot Polyline V/F 2: VF to the 1.3rd 3: VF to the 1.7th 4: Square V/F 5: VF Complete Split Mode (Ud=0, Uq=K*t=Split Voltage Source Voltage) 6: VF Half-Split Mode (Ud=0,		0	○

EM500 Open-Loop Vector Control Inverter User Manual

		$U_q = K \cdot t = F / Fe \cdot 2 \cdot \text{Split voltage source voltage}$			
F05.01	Multipoint VF Frequency Point F1	0.00 - F05.03	Hz	0.50	●
F05.02	Multipoint VF Voltage Point V1	0.0 - 100.0 (100.0= Motor Rated Voltage)	%	1.0	●
F05.03	Multipoint VF Frequency Point F2	F05.01 - F05.05	Hz	2.00	●
F05.04	Multipoint VF Voltage Point V2	0.0 - 100.0	%	4.0	●
F05.05	Multipoint VF Frequency Point F3	F05.03 - Motor Rated Frequency (Reference Frequency)	Hz	5.00	●
F05.06	Multipoint VF Voltage Point V3	0.0 - 100.0	%	10.0	●
F05.07	Voltage Source of VF Separation Mode	0: Numeric Setting of VF Separation Voltage 1: AI1 2: AI2 3: AI3 4: High-Frequency Pulse (X7) 5: PID 6: Communication Percentage Setting Note: Motor Rated Voltage is 100%		0	○
F05.08	Numeric Setting of VF Separation Voltage	0.0 - 100.0 (100.0= Motor Rated Voltage)	%	0.0	●
F05.09	Rise Time of VF Separation Voltage	0.00 - 60.00	s	2.00	●
F05.10	V/F Stator Voltage Drop Compensation Gain	0.00 - 200.00	%	100.00	●
F05.11	V/F Slip Compensation Gain	0.00 - 200.00	%	100.00	●
F05.12	V/F Slip Filter Time	0.00 - 10.00	s	1.00	●
F05.13	Oscillation Suppression Gain	0 - 20000		100	●
F05.14	Oscillation Suppression End Frequency	0.00 - 600.00	Hz	55.00	●

EM500 Open-Loop Vector Control Inverter User Manual

F05.15	Sagging Control Frequency	0.00 - 10.00	Hz	0.00	●
F05.16	Energy Saving Rate	0.00 - 50.00	%	0.00	●
F05.17	Energy Saving Actuation Time	1.00 - 60.00	s	5.00	●
F05.18	Compensation Gain of Magnetic Flux of Synchronous Motor	0.00 - 500.00	%	100.00	●
F05.19	Filter Time Constant of Magnetic Flux Compensation of Synchronous Motor	0.00 - 10.00	s	0.50	●
F06	Vector Control Parameter Group				
F06.00	Speed Proportional Gain ASR_P1	0.00 - 100.00		12.00	●
F06.01	Speed Integral Time Constant ASR_T1	0.000 - 30.000 0.000: No Integral	s	0.200	●
F06.02	Speed Proportional Gain ASR_P2	0.00 - 100.00		8.00	●
F06.03	Speed Integral Time Constant ASR_T2	0.000 - 30.000 0.000: No Integral	s	0.300	●
F06.04	Switching Frequency 1	0.00 - Switching Frequency 2	Hz	5.00	●
F06.05	Switching Frequency 2	Switching Frequency 1 - Maximum Frequency F00.16	Hz	10.00	●
F06.06	Speed Loop Anti-Saturation Factor	0.000 - 1.000		0.500	●
F06.07	Time Constant of Output Filter of Speed Loop	0.000 - 0.100	s	0.001	●
F06.08	Vector Control Slip Gain	50.00 - 200.00	%	100.00	●
F06.09	Speed control torque limit source selection	0: F06.10 and F06.11 1: AI1 2: AI2 3: AI3 4: AI4 (Expansion Card) 5: communication 6: maximum of AI2 and AI3		0	○

EM500 Open-Loop Vector Control Inverter User Manual

		7: minimum of AI2 and AI3			
F06.10	Upper Limit of Electric Torque for Speed Control	0.0 - 250.0	%	165.0	●
F06.11	Upper Limit of Brake Torque for Speed Control	0.0 - 250.0	%	165.0	●
F06.12	Excitation Current Proportional Gain ACR-P1	0.00 - 100.00		0.50	●
F06.13	Excitation Current Integral Time Constant ACR-T1	0.00 - 600.00 0.00: No Integral	ms	10.00	●
F06.14	Torque Current Proportional Gain ACR-P2	0.00 - 100.00		0.50	●
F06.15	Torque Current Integral Time Constant ACR-T2	0.00 - 600.00 0.00: No Integral	ms	10.00	●
F06.16	Position Loop Gain	0.000 - 40.000		1.000	●
F06.17	SVC Control Mode at Zero Frequency	0: Brake 1: Normal 2: No output		2	○
F06.18	SVC Zero Frequency Band-Type Brake Current	50.0 - 400.0 (100.0=Idling Current)	%	100.0	○
F06.19	Not Used				
F06.20	Voltage Feedforward Gain	0 - 100	%	0	●
F06.21	Field Weakening Control Options of Synchronous Motor	0: Disabled 1: Direct Calculation 2: Automatic Adjustment		1	○
F06.22	Field Weakening Factor of Synchronous Motor	100.00 - 200.00	%	100.00	●
F06.23	Maximum Field Weakening Current of Synchronous Motor	0.0 - 150.0 (100.0= Motor Rated Current)	%	50.0	●

EM500 Open-Loop Vector Control Inverter User Manual

F06.24	Proportional Gain of Field Weakening Regulator of Synchronous Motor	0.00 - 10.00		0.50	●
F06.25	Integral Time of Field Weakening Regulator of Synchronous Motor	0.00 - 6000.00	ms	100.00	●
F06.26	MTPA Control Options of Synchronous Motor	0: Disabled 1: Enabled		0	○
F06.27	Gain of Autotuning at Initial Position	0 - 600	%	80	●
F06.28	Frequency of Injection Current at Low Frequency Range	0.00 - 100.00 (100.00= Motor Rated Frequency)	%	10.00	●
F06.29	Injection Current at Low Frequency Range	0.0 - 60.0 (100.0= Motor Rated Current)	%	20.0	●
F06.30	Low Frequency Range Regulator Gain of Injection Current	0.00 - 10.00		0.50	●
F06.31	Integral Time of Low Frequency Range Regulator of Injection Current	0.00 - 300.00	ms	10.00	●
F06.32	Frequency of Injection Current at High Frequency Range	0.00 - 100.00 (100.00= Motor Rated Frequency)	%	20.00	●
F06.33	Injection Current at High Frequency Range	0.0 - 30.0 (100.0= Motor Rated Current)	%	8.0	●
F06.34	High Frequency Range Regulator Gain of Injection Current	0.00 - 10.00		0.50	●
F06.35	Integral Time of	0.00 - 300.00	ms	10.00	●

EM500 Open-Loop Vector Control Inverter User Manual

	High Frequency Range Regulator of Injection Current											
F06.36	Synchronous motor current loop proportional gain	10.00~600.00	%	100.00								
F06.37	Synchronous motor current loop integral gain	10.00~600.00	%	100.00	○							
F06.38 ~ F06.40	Not Used											
F06.41	Low frequency Mode	0: mode 0 1: mode 1 2-3: Not Used		0	○							
F06.42	Low frequency processing frequency	0.0~50.0	%	8.0	○							
F06.43	Sink Current	0.0~600.0	%	80.0	○							
F06.44 ~ F06.45	Not Used											
F06.46	Synchronous Motor speed tracking proportional gain	0.00~10.00		1.00	○							
F06.47	Synchronous Motor speed tracking integral gain	0.00~10.00		1.00	○							
F06.48	Synchronous Motor speed tracking filter time	0.00~10.00	ms	0.40	○							
F06.49	Synchronous Motor speed tracking control Coefficient	1.0~100.0		5.0	○							
F06.50	Synchronous Motor speed tracking control threshold	0.00~10.00		0.20	○							
F07	Protection Function Setting Group											
F07.00	Protection block	E20	E22	E13	SLU	SOU	SOC	ILP	OLP		000	○

EM500 Open-Loop Vector Control Inverter User Manual

		0: Valid Protection 1: Protection blocked		00000	
F07.01	Motor Overload Protection Gain	0.20 - 10.00`		1.00	●
F07.02	Motor Overload Pre-Alarming Factor	50 - 100	%	80	●
F07.03	Motor Temperature Sensor Type	0: No Temperature Sensor 1: PT100 2: PT1000 3: KTY84-130/150 4: PTC130/150		0	●
F07.04	Motor Overheating Protection Threshold	0 - 200	°C	110	●
F07.05	Motor Overheating Pre-Alarming Threshold	0 - 200	°C	90	●
F07.06	Bus Voltage Control Options	0: Disabled 1: Undervoltage Stall, Enabled 2: Overvoltage Stall, Enabled 3: Overvoltage Stall and Undervoltage Stall, Enabled		2	○
F07.07	Overvoltage Stall Control Voltage	110.0 - 150.0 (380V,100.0=537V)	%	131.0 (703V)	○
F07.08	Undervoltage Stall Control Voltage	60.0 - Judgment Voltage at Power Failure Ending (100.0= Standard Bus Voltage)	%	76.0	○
F07.09	Judgment Voltage at Power Failure Ending	Undervoltage Stall Control Voltage - 100.0	%	86.0	●
F07.10	Judgment Delay Time at Power Failure Ending	0.00 - 100.00	s	5.00	●
F07.11	Current Limit Control	0: Disabled 1: Limit Mode 1 2: Limit Mode 2		2	○
F07.12	Current Limit Level	20.0 - 180.0 (100.0= Inverter Rated Current)	%	150.0	●
F07.13	Rapid Current Limit	0: Disabled 1: Enabled		0	○
F07.14	Fault Retry Times	0 - 20, 0: Fault Retry Disabled		0	○

EM500 Open-Loop Vector Control Inverter User Manual

F07.15	Numeric Output Action at Fault Retry	0: Disabled 1: Enabled		0	○
F07.16	Fault Retry Interval	0.01 - 30.00	s	0.50	●
F07.17	Recovery Time of Fault Retry Times	0.01 - 30.00	s	10.00	●
F07.18	Fault Retry	<i>ILP</i> <i>HOU</i> <i>HOC</i> <i>SLU</i> <i>SOU</i> <i>SOC</i>		**0 00000	○
		0: Permitted 1: Not Permitted			
F07.19	Action 1 at Fault	<i>E21</i> <i>E15</i> <i>E15</i> <i>E14</i> <i>E13</i> <i>E12</i> <i>OLP</i> <i>ILP</i>		000 00000	○
		0: Coast to Stop 1: Stop as per Set Stop Mode			
F07.20	Action 2 at Fault	<i>E28</i> <i>E27</i> <i>E25</i> <i>E23</i>		*0000	○
		0: Coast to Stop 1: Stop as per Set Stop Mode			
F07.21	Offload Protection	0: Disabled 1: Enabled		0	●
F07.22	Offload Detection Level	0.0 - 100.0	%	20.0	●
F07.23	Load Detection Time	0.0 - 60.0	s	1.0	●
F07.24	Offload Protection	0: Coast to Stop 1: Stop as per Set Stop Mode		1	○
F07.25 - F07.26	Not Used				
F07.27	AVR	0: Disable 1: Enable 2: Automatic		1	○
F07.28	Stall fault detection time	0.0~6000.0	s	300.0	○
F07.29	The intensity of stall control	0~100	%	100	○
F08	Preset Speed and Simple PLC				
F08.00	Preset Speed 1	0.00 - Maximum Frequency F00.16	Hz	0.00	●
F08.01	Preset Speed 2	0.00 - Maximum Frequency F00.16	Hz	5.00	●
F08.02	Preset Speed 3	0.00 - Maximum Frequency F00.16	Hz	10.00	●
F08.03	Preset Speed 4	0.00 - Maximum Frequency F00.16	Hz	15.00	●
F08.04	Preset Speed 5	0.00 - Maximum Frequency F00.16	Hz	20.00	●

EM500 Open-Loop Vector Control Inverter User Manual

F08.05	Preset Speed 6	0.00 - Maximum Frequency F00.16	Hz	25.00	●
F08.06	Preset Speed 7	0.00 - Maximum Frequency F00.16	Hz	30.00	●
F08.07	Preset Speed 8	0.00 - Maximum Frequency F00.16	Hz	35.00	●
F08.08	Preset Speed 9	0.00 - Maximum Frequency F00.16	Hz	40.00	●
F08.09	Preset Speed 10	0.00 - Maximum Frequency F00.16	Hz	45.00	●
F08.10	Preset Speed 11	0.00 - Maximum Frequency F00.16	Hz	50.00	●
F08.11	Preset Speed 12	0.00 - Maximum Frequency F00.16	Hz	50.00	●
F08.12	Preset Speed 13	0.00 - Maximum Frequency F00.16	Hz	50.00	●
F08.13	Preset Speed 14	0.00 - Maximum Frequency F00.16	Hz	50.00	●
F08.14	Preset Speed 15	0.00 - Maximum Frequency F00.16	Hz	50.00	●
F08.15	Simple PLC Running Mode	0: Stop after Single Running 1: Stop after Limited Times of Cycles 2: Run at Last Preset Speed after Limited Times of Cycles 3: Continuous Cycle		0	●
F08.16	Limited Times of Cycles	1 - 10000		1	●
F08.17	Simple PLC Memory	Ones Place: Stop Memory 0: Disabled (Start from Preset Speed 1) 1: Enabled (Start at Power Failure) Tens Place: Power Failure Memory 0: Disabled (Start from Preset Speed 1) 1: Enabled (Start at Power Failure)		0	●
F08.18	Simple PLC Time Unit	0: s 1: min		0	●
F08.19	Setting of Preset Speed 1	Ones Place: Running Direction 0: Forward 1: Reverse Tens Place: Acceleration/Deceleration Time 0: Acceleration/Deceleration Time 1 1: Acceleration/Deceleration Time 2 2: Acceleration/Deceleration Time 3 3: Acceleration/Deceleration Time 4		0	●
F08.20	Running Time of Preset Speed 1	0.0 - 6000.0		5.0	●
F08.21	Setting of Preset Speed 2	Ones Place: Running Direction 0: Forward 1: Reverse Tens Place: Acceleration/Deceleration		0	●

		Time 0: Acceleration/Deceleration Time 1 1: Acceleration/Deceleration Time 2 2: Acceleration/Deceleration Time 3 3: Acceleration/Deceleration Time 4			
F08.22	Running Time of Preset Speed 2	0.0 - 6000.0		5.0	●
F08.23	Running Time of Preset Speed 3	Ones Place: Running Direction 0: Forward 1: Reverse Tens Place: Acceleration/Deceleration Time 0: Acceleration/Deceleration Time 1 1: Acceleration/Deceleration Time 2 2: Acceleration/Deceleration Time 3 3: Acceleration/Deceleration Time 4		0	●
F08.24	Running Time of Preset Speed 3	0.0 - 6000.0		5.0	●
F08.25	Setting of Preset Speed 4	Ones Place: Running Direction 0: Forward 1: Reverse Tens Place: Acceleration/Deceleration Time 0: Acceleration/Deceleration Time 1 1: Acceleration/Deceleration Time 2 2: Acceleration/Deceleration Time 3 3: Acceleration/Deceleration Time 4		0	●
F08.26	Running Time of Preset Speed 4	0.0 - 6000.0		5.0	●
F08.27	Setting of Preset Speed 5	Ones Place: Running Direction 0: Forward 1: Reverse Tens Place: Acceleration/Deceleration Time 0: Acceleration/Deceleration Time 1 1: Acceleration/Deceleration Time 2 2: Acceleration/Deceleration Time 3 3: Acceleration/Deceleration Time 4		0	●
F08.28	Running Time of Preset Speed 5	0.0 - 6000.0		5.0	●

F08.29	Setting of Preset Speed 6	Ones Place: Running Direction 0: Forward 1: Reverse Tens Place: Acceleration/Deceleration Time 0: Acceleration/Deceleration Time 1 1: Acceleration/Deceleration Time 2 2: Acceleration/Deceleration Time 3 3: Acceleration/Deceleration Time 4	0	•
F08.30	Running time of Preset Speed 6	0.0 - 6000.0	5.0	•
F08.31	Setting of Preset Speed 7	Ones Place: Running Direction 0: Forward 1: Reverse Tens Place: Acceleration/Deceleration Time 0: Acceleration/Deceleration Time 1 1: Acceleration/Deceleration Time 2 2: Acceleration/Deceleration Time 3 3: Acceleration/Deceleration Time 4	0	•
F08.32	Running Time of Preset Speed 7	0.0 - 6000.0	5.0	•
F08.33	Setting of Preset Speed 8	Ones Place: Running Direction 0: Forward 1: Reverse Tens Place: Acceleration/Deceleration Time 0: Acceleration/Deceleration Time 1 1: Acceleration/Deceleration Time 2 2: Acceleration/Deceleration Time 3 3: Acceleration/Deceleration Time 4	0	•
F08.34	Running Time of Preset Speed 8	0.0 - 6000.0	5.0	•
F08.35	Setting of Preset Speed 9	Ones Place: Running Direction 0: Forward 1: Reverse Tens Place: Acceleration/Deceleration Time 0: Acceleration/Deceleration Time 1 1: Acceleration/Deceleration Time 2	0	•

EM500 Open-Loop Vector Control Inverter User Manual

		2: Acceleration/Deceleration Time 3 3: Acceleration/Deceleration Time 4			
F08.36	Running Time of Preset Speed 9	0.0 - 6000.0		5.0	●
F08.37	Setting of Preset Speed 10	Ones Place: Running Direction 0: Forward 1: Reverse Tens Place: Acceleration/Deceleration Time 0: Acceleration/Deceleration Time 1 1: Acceleration/Deceleration Time 2 2: Acceleration/Deceleration Time 3 3: Acceleration/Deceleration Time 4		0	●
F08.38	Running Time of Preset Speed 10	0.0 - 6000.0		5.0	●
F08.39	Setting of Preset Speed 11	Ones Place: Running Direction 0: Forward 1: Reverse Tens Place: Acceleration/Deceleration Time 0: Acceleration/Deceleration Time 1 1: Acceleration/Deceleration Time 2 2: Acceleration/Deceleration Time 3 3: Acceleration/Deceleration Time 4		0	●
F08.40	Running Time of Preset Speed 11	0.0 - 6000.0		5.0	●
F08.41	Setting of Preset Speed 12	Ones Place: Running Direction 0: Forward 1: Reverse Tens Place: Acceleration/Deceleration Time 0: Acceleration/Deceleration Time 1 1: Acceleration/Deceleration Time 2 2: Acceleration/Deceleration Time 3 3: Acceleration/Deceleration Time 4		0	●
F08.42	Running Time of Preset Speed 12	0.0 - 6000.0		5.0	●
F08.43	Setting of Preset Speed 13	Ones Place: Running Direction 0: Forward 1: Reverse		0	●

		Tens Place: Acceleration/Deceleration Time 0: Acceleration/Deceleration Time 1 1: Acceleration/Deceleration Time 2 2: Acceleration/Deceleration Time 3 3: Acceleration/Deceleration Time 4			
F08.44	Running Time of Preset Speed 13	0.0 - 6000.0		5.0	●
F08.45	Setting of Preset Speed 14	Ones Place: Running Direction 0: Forward 1: Reverse Tens Place: Acceleration/Deceleration Time 0: Acceleration/Deceleration Time 1 1: Acceleration/Deceleration Time 2 2: Acceleration/Deceleration Time 3 3: Acceleration/Deceleration Time 4		0	●
F08.46	Running Time of Preset Speed 14	0.0 - 6000.0		5.0	●
F08.47	Setting of Preset Speed 15	Ones Place: Running Direction 0: Forward 1: Reverse Tens Place: Acceleration/Deceleration Time 0: Acceleration/Deceleration Time 1 1: Acceleration/Deceleration Time 2 2: Acceleration/Deceleration Time 3 3: Acceleration/Deceleration Time 4		0	●
F08.48	Running Time of Preset Speed 15	0.0 - 6000.0		5.0	●
F09	PID Function Group				
F09.00	PID Setting Source	0: Numeric PID Setting 1: AI1 2: AI2 3: AI3 4: AI4 (Expansion Card) 5: PULSE High-Frequency Pulse (X7) 6: Communication Percentage Setting		0	○
F09.01	Numeric PID Setting	0.0 – PID Setting Feedback Range F09.03		0.0	●

EM500 Open-Loop Vector Control Inverter User Manual

F09.02	PID Feedback Source	1: AI1 2: AI2 3: AI3 4: AI4 (Expansion Card) 5: High-Frequency Pulse (X7) 6: Communication Percentage Setting		1	○
F09.03	PID Setting Feedback Range	0.1 - 6000.0		100.0	●
F09.04	PID Positive/Negative Action	0: Positive Action 1: Negative Action		0	○
F09.05	Proportional Gain 1	0.00 - 100.00		0.40	●
F09.06	Integral Time 1	0.000 - 30.000, 0.000: No Integral	s	10.000	●
F09.07	Differential Time 1	0.000 - 30.000	ms	0.000	●
F09.08	Proportional Gain 2	0.00 - 100.00		0.40	●
F09.09	Integral Time 2	0.000 - 30.000, 0.000: No Integral	s	10.000	●
F09.10	Differential Time 2	0.000 - 30.000	ms	0.000	●
F09.11	PID Parameter Switching	0: Disabled 1: Switching through Numeric Input Terminal 2: Automatic Switching by Offset		0	●
F09.12	PID Parameter Switching Offset 1	0.00 - F09.13	%	20.00	●
F09.13	PID Parameter Switching Offset 2	F09.12 - 100.00	%	80.00	●
F09.14	PID Initial Value	0.00 - 100.00	%	0.00	●
F09.15	PID Initial Value Retention Time	0.00 - 650.00	s	0.00	●
F09.16	Upper Limit of PID Output	F09.17 ~ +100.0	%	100.0	●
F09.17	Lower Limit of PID Output	-100.0 - F09.16	%	0.0	●
F09.18	PID Offset Limit	0.00 - 100.00, Disabled at 0.00	%	0.00	●
F09.19	PID Differential Limit	0.00 - 100.00	%	5.00	●
F09.20	PID Integral Separation Threshold	0.00 - 100.00, (100.00%=Integral Separation Disabled)	%	100.00	●
F09.21	PID Setting	0.000 - 30.000	s	0.000	●

EM500 Open-Loop Vector Control Inverter User Manual

	Variation Time				
F09.22	PID Feedback Filter Time	0.000 - 30.000	s	0.000	●
F09.23	PID Output Filter Time	0.000 - 30.000	s	0.000	●
F09.24	Upper Limit Detection Value of PID Feedback Disconnection	0.00 - 100.00 100.00=Feedback Disconnection Disabled	%	100.00	●
F09.25	Lower Limit Detection Value of PID Feedback Disconnection	0.00 - 100.00 0.00=Feedback Disconnection Disabled	%	0.00	●
F09.26	PID Feedback Disconnection Detection Time	0.000 - 30.000	s	0.000	●
F09.27	PID Sleep Control	0: Disable 1: Enable 2: Lower Limit Frequency Enable 3: No Output Enable		0	●
F09.28	Sleep Action Point	0.00 - 100.00 (100.00 corresponds to PID Setting Feedback Range)	%	100.00	●
F09.29	Sleep Delay Time	0.0 - 6500.0	s	0.0	●
F09.30	Awakening Action Point	0.00 - 100.00 (100.00 corresponds to PID Setting Feedback Range)	%	0.00	●
F09.31	Awakening Delay Time	0.0 - 6500.0	s	0.0	●
F09.32	Preset PID Setting 1	0.0 – PID Setting Feedback Range F09.03		0.0	●
F09.33	Preset PID Setting 2	0.0 – PID Setting Feedback Range F09.03		0.0	●
F09.34	Preset PID Setting 3	0.0 – PID Setting Feedback Range F09.03		0.0	●
F09.35	The Feedback Voltage Upper Limit	The feedback voltage lower limit~10.00	V	10.00	●
F09.36	The Feedback Voltage Lower Limit	0.00~ The Feedback Voltage Upper Limit	V	0.00	●
F09.37	PID Integral Action Choice in time of	0: Always calculate integral item 1: Start calculating Integral item When		0	●

EM500 Open-Loop Vector Control Inverter User Manual

	change	the time set in F09.21 has arrived 2: Start calculating integral item when the error is less than F09.38			
F09.38	PID Integral Action Given Change Ttime Input Deviation	0.00-100.00	%	30.00	●
F10	Communication Function Group				
F10.00	Inverter Address	1 - 247, 0 as broadcasting address		1	○
F10.01	Modbus Communication Bit Rate	0: 4800 1: 9600 2: 19200 3: 38400 4: 57600 5: 115200		1	○
F10.02	Modbus Data Format	0: 1-8-N-1 (1 start bit + 8 data bits + 1 stop bit) 1: 1-8-E-1 (1 start bit + 8 data bits + 1 even parity + 1 stop bit) 2: 1-8-O-1 (1 start bit + 8 data bits + 1 odd parity + 1 stop bit) 3: 1-8-N-2 (1 start bit + 8 data bits + 2 stop bits) 4: 1-8-E-2 (1 start bit + 8 data bits + 1 even parity + 2 stop bits) 5: 1-8-O-2 (1 start bit + 8 data bits + 1 odd parity + 2 stop bits)		0	○
F10.03	Modbus Overtime	0.0 - 60.0, 0.0: Disabled (also works for master - slave system)	s	0.0	●
F10.04	Modbus Response Delay	1 - 20	ms	2	●
F10.05	Master-Slave Communication Function	0: Disabled 1: Enabled		0	○
F10.06	Master-Slave Options	0: Slave 1: Master (Modbus protocol) 2: Master (CANSinee protocol)		0	○
F10.07	Data Sent by Master	0: Output Frequency 1: Set Frequency 2: Output Torque 3: Set Torque		1	○

EM500 Open-Loop Vector Control Inverter User Manual

		4: PID Setting 5: Output Current			
F10.08	Receiving Proportionality Factor of Slave	0.00 - 10.00 (Times)		1.00	●
F10.09	Sending Interval of Master	0.000 - 30.000	s	0.200	●
F10.10	Communication Protocol	0: Modbus-RTU Protocol 1: Profibus-DP Protocol 2: CANopen Protocol 3: DeviceNet Protocol		0	○
F10.11	Communication Address of Profibus-DP Expansion Card	1 - 125		1	○
F10.12	Communication Address of CANopen Expansion Card	1 - 127		1	○
F10.13	Communication Address of DeviceNet Expansion Card	0 - 63		1	○
F10.14	Response Delay Time of Process Data of Communication Card	0.0 - 200.0	ms	0.0	○
F10.15	Bit Rate of Communication between Expansion Card and Bus	Ones Place: CANopen 0: 125K 1: 250K 2: 500K 3: 1M Tens Place: DeviceNet 0: 125K 1: 250K 2: 500K		23	○
F10.16	PROFIBUS Communication Format	0: PPO1 1: PPO2 2: PPO3			×

		3: PPO4 4: PPO5		
F10.17	Received Data Type PZD2	<p>When the displayed data is 65535, it means that present PZD is not used.</p> <p>When the displayed data is other data, for example 4609, it means that the function parameter is F18.01 (18D=12H, 01D=01H, 1201H=4609D)</p>	65535	○
F10.18	Received Data Type PZD3		65535	○
F10.19	Received Data Type PZD4		65535	○
F10.20	Received Data Type PZD5		65535	○
F10.21	Received Data Type PZD6		65535	○
F10.22	Received Data Type PZD7		65535	○
F10.23	Received Data Type PZD8		65535	○
F10.24	Received Data Type PZD9		65535	○
F10.25	Received Data Type PZD10		65535	○
F10.26	Received Data Type PZD11		65535	○
F10.27	Received Data Type PZD12		65535	○
F10.28	Received Data Type PZD13		65535	○
F10.29	Received Data Type PZD14		65535	○
F10.30	Received Data Type PZD15		65535	○
F10.31	Received Data Type PZD16		65535	○
F10.32	Sent Data Type PZD2		65535	○
F10.33	Sent Data Type PZD3		65535	○
F10.34	Sent Data Type PZD4	65535	○	
F10.35	Sent Data Type PZD5	65535	○	

F10.36	Sent Data Type PZD6		65535	○
F10.37	Sent Data Type PZD7		65535	○
F10.38	Sent Data Type PZD8		65535	○
F10.39	Sent Data Type PZD9		65535	○
F10.40	Sent Data Type PZD10		65535	○
F10.41	Sent Data Type PZD11		65535	○
F10.42	Sent Data Type PZD12		65535	○
F10.43	Sent Data Type PZD13		65535	○
F10.44	Sent Data Type PZD14		65535	○
F10.45	Sent Data Type PZD15		65535	○
F10.46	Sent Data Type PZD16		65535	○
F10.47	Communication Card Status	<p>Ones Place: Profibus-DP 0: Initialization Status 1: Wait for Parameterization Status 2: Wait for Configuration Status 3: Data Exchange Status 4: Modbus Communication Abnormality Status 5: Factory Test Status</p> <p>Tens Place: CANopen 0: Initialization Status 1: Pre-Operation Status 2: Operation Status 3: Stop Status 4: CANopen Communication Abnormality Status 5: Modbus Communication Abnormality Status 6: Factory Test Status</p>	000	×

		Hundreds Place: DeviceNet 0: Initialization Status 1: MACID Detection Status 2: Online Non-Connection Status 3: Connection Status 4: IO Communication Overtime Status 5: DeviceNet Bus Communication Abnormality Status 6: Modbus Communication Abnormality Status 7: Factory Test Status			
F10.48	Communication Card Software Version				×
F10.49	number of process data received	1~16		2	●
F10.50	number of process data transmission	1~16		2	●
F10.51	Process data address setting mode selection	0: keypad 1: Master		0	●
F10.52	Communication card manual reset selection	0: disable 1: enable		0	●
F10.53	CANSinee Communication address	1~31		1	○
F10.54	CANSinee Communication baud rate	0: 125K 1: 250K 2: 500K 3: 1M		0	○
F10.55	CANSinee Communication timeout	0.0 - 60.0, 0.0: Disabled (also works for master - slave system)	s	0.0	●
F10.56	RS485write EEPROM	0~10: default for debugging 11: No trigger write before debugging		0	○
F11	User-Defined Parameter Group				
F11.00	User-Defined Parameter 1	The content displays Uxx.xx, which means that function code Fxx.xx is selected. If keypad displays U00.00 at		U00.00	●
F11.01	User-Defined			U00.01	●

	Parameter 2	the time of entering the function code F11.00, it means that the first user-defined parameter is F00.00.		
F11.02	User-Defined Parameter 3		U00.02	●
F11.03	User-Defined Parameter 4		U00.03	●
F11.04	User-Defined Parameter 5		U00.04	●
F11.05	User-Defined Parameter 6		U00.07	●
F11.06	User-Defined Parameter 7		U00.14	●
F11.07	User-Defined Parameter 8		U00.15	●
F11.08	User-Defined Parameter 9		U00.16	●
F11.09	User-Defined Parameter 10		U00.18	●
F11.10	User-Defined Parameter 11		U00.19	●
F11.11	User-Defined Parameter 12		U00.29	●
F11.12	User-Defined Parameter 13		U02.00	●
F11.13	User-Defined Parameter 14		U02.01	●
F11.14	User-Defined Parameter 15		U02.02	●
F11.15	User-Defined Parameter 16		U03.00	●
F11.16	User-Defined Parameter 17		U03.02	●
F11.17	User-Defined Parameter 18		U03.21	●
F11.18	User-Defined Parameter 19		U04.00	●
F11.19	User-Defined Parameter 20		U04.20	●
F11.20	User-Defined Parameter 21		U05.00	●
F11.21	User-Defined		U05.03	●

	Parameter 22			
F11.22	User-Defined Parameter 23		U05.04	●
F11.23	User-Defined Parameter 24		U08.00	●
F11.24	User-Defined Parameter 25		U19.00	●
F11.25	User-Defined Parameter 26		U19.01	●
F11.26	User-Defined Parameter 27		U19.02	●
F11.27	User-Defined Parameter 28		U19.03	●
F11.28	User-Defined Parameter 29		U19.04	●
F11.29	User-Defined Parameter 30		U19.05	●
F11.30	User-Defined Parameter 31		U19.06	●
F11.31	User-Defined Parameter 32		U19.12	●
F12	Keypad and Display Function Group			
F12.00	M.K	0: No Function 1: Forward JOG 2: Reverse JOG 3: Forward/Reverse Switch 4: Rapid Stop 5: Coast to Stop 6: Cursor Left Shift	1	○
F12.01	STOP	0: Valid Only at Keypad Control 1: Valid at All Command Channels	1	○
F12.02	Parameter Locking	0: Unlocked 1: Reference Input, Unlocked 2: All Locked Except this Function Code	0	●
F12.03	Parameter Copy	0: No Autotuning 1: Upload Parameter to Keypad 2: Download Parameter to Inverter	0	○
F12.04	LED Display Parameter 1	00000000 - 11111111 (o for non-displaying, 1 for displaying) bit0: Output Frequency	000 11111	●

		bit1: Set Frequency bit2: Output Current bit3: Output Voltage bit4: DC Bus Voltage bit5: Output Power bit6: Output Torque bit7: Torque Setting			
F12.05	LED Display Parameter 2	00000000 - 11111111 (o for non-displaying, 1 for displaying) bit0: Not Used bit1: Estimated Feedback Frequency bit2: Load Speed bit3: Numeric Input Terminal Status 1 bit4: Numeric Input Terminal Status 2 bit5: Numeric Input Terminal Status 3 bit6: Numeric Output Terminal Status bit7: AI1		000 00000	●
F12.06	LED Display Parameter 3	00000000 - 11111111 (o for non-displaying, 1 for displaying) bit0: AI2 bit1: AI3 bit2: AI4 bit3: PID Input bit4: PID Feedback bit5: Count Value bit6: Actual Length bit7: High-Frequency Pulse Input Frequency: kHz		000 00000	●
F12.07	LED Display Parameter 4	00000000 - 11111111 (o for non-displaying, 1 for displaying) bit0: High-Frequency Pulse Input Frequency, Hz bit1: kilowatt-hour meter, MWh bit2: kilowatt-hour meter, kWh bit3: Remaining Time of Timed Run bit4: Simple PLC Running Times bit5: Simple PLC Running Stage bit6: PLC Running Time of Present Stage bit7: Not Used		000 00000	●
F12.08	LED Display	00000000 - 00001111 (o for		***	●

EM500 Open-Loop Vector Control Inverter User Manual

	Parameter 5	non-displaying, 1 for displaying) bit0: UP/DOWN Offset bit1: VF Separation Output Voltage bit2: VF Separation Target Voltage bit3: Motor Temperature bit4 - bit7: Not Used		*0000	
F12.09	Load Speed Display Factor	0.01 - 600.00		30.00	●
F12.10	UP/DOWN Acceleration/Deceleration Rate	0.00: Automatic Rate 0.01 - 500.00	Hz/s	5.00	○
F12.11	UP/DOWN Offset Clear	0: Not to Clear 1: Clear at Non-Running Status 2: Clear at Disabled UP/DOWN		1	○
F12.12	Power Failure Save of UP/DOWN Offset	0: Disabled 1: Enabled (only at modified offset)		0	○
F12.13	Kilowatt-Hour Meter Clear	0: Not to Clear 1: Clear		0	●
F12.14	Reset	0: No Autotuning 1: Reset (exclusive of motor parameter, inverter parameter, manufacturer parameter, running and power-on time record)		0	○
F12.15	Accumulated Power-On Time h	0 - 65535	h	XXX	×
F12.16	Accumulated Power-On Time min	0 - 59	min	XXX	×
F12.17	Accumulated Running Time h	0 - 65535	h	XXX	×
F12.18	Accumulated Running Time min	0 - 59	min	XXX	×
F12.19	Inverter Rated Power	0.40 - 650.00	kW	Up To Specific Model	×
F12.20	Inverter Rated Voltage	60 - 690	V	Up To Specific Model	×
F12.21	Inverter Rated Current	0.1 - 1500.0	A	Up To Specific	×

			Model	
F12.22	Performance Software Serial Number1	XXX.XX	XXX.X X	×
F12.23	Performance Software Serial Number2	XX.XXX	XX.XX X	×
F12.24	Function Software Serial Number 1	XXX.XX	XXX.X X	×
F12.25	Function Software Serial Number 2	XX.XXX	XX.XX X	×
F12.26	Keypad Software Serial Number 1	XXX.XX	XXX.X X	×
F12.27	Keypad Software Serial Number 2	XX.XXX	XX.XX X	×
F12.28	Product Serial Number 1	XX.XXX	XX.XX X	×
F12.29	Product Serial Number 2	XXXX.X	XXXX. X	×
F12.30	Product Serial Number 3	XXXXX	XXXX X	×
F12.31	LCD Language	0: Chinese 1: English 2: Not Used	0	●
F12.32	Monitor mode	0: Mode 0 1: Mode 1	1	●
F12.33	Mode 1 display parameter 1 (LED Stop status display parameter 5)	0.00~99.99	18.00	●
F12.34	Mode 1 display parameter 2 (LED Stop status display parameter 1)	0.00~99.99	18.01	●
F12.35	Mode 1 display parameter 3 (LED Stop status display parameter 2)	0.00~99.99	18.06	●
F12.36	Mode 1 display parameter 4 (LED	0.00~99.99	18.08	●

	Stop status display parameter 3)				
F12.37	Mode 1 display parameter 5 (LED Stop status display parameter 4)	0.00~99.99		18.09	●
F12.38	LCD display parameter 1	0.00~99.99		18.00	●
F12.39	LCD display parameter 2	0.00~99.99		18.06	●
F12.40	LCD display parameter 3	0.00~99.99		18.09	●
F12.41	UP/DOWN cross zero option	0: forbidden 1: allowed		0	○
F12.42	Digital potentiometer frequency reference	0.00~F00.16	Hz	0.00	×
F12.43	Digital potentiometer torque reference	0.00~ F13.02	%	0.0	×
F13	Torque Control Parameter Group				
F13.00	Speed/Torque Control	0: Speed Control 1: Torque Control		0	○
F13.01	Torque Setting	0: Numeric Torque Setting F13.02 1: AI1 2: AI2 3: AI3 4: AI4 (Expansion Card) 5: High-Frequency Pulse Input (X7) 6: Communication Percentage Setting (Full ranges of options 1 to 6, correspond to numeric torque setting F13.02) 7: Not Used 8: digital potentiometer		0	○
F13.02	Numeric Torque Setting	-200.0 - 200.0 (100.0= Motor Rated Torque)	%	100.0	●
F13.03	Preset Torque 1	-200.0 - 200.0	%	0.0	●
F13.04	Preset Torque 2	-200.0 - 200.0	%	0.0	●
F13.05	Preset Torque 3	-200.0 - 200.0	%	0.0	●

EM500 Open-Loop Vector Control Inverter User Manual

F13.06	Torque Control Acceleration/Deceleration Time	0.00 - 120.00	s	0.05	●
F13.07	Not Used				
F13.08	Upper Limit Frequency of Torque Control	0: Set through F13.09 1: AI1 2: AI2 3: AI3 4: AI4 (Expansion Card) 5: High-Frequency Pulse Input (X7) 6: Communication Percentage Setting 7: Direct Communication Setting		0	○
F13.09	Upper Limit Frequency of Torque Control	0.00 - Maximum Frequency F00.16	Hz	50.00	●
F13.10	Upper Limit Frequency Offset	0.00 - Maximum Frequency F00.16	Hz	0.00	●
F13.11	Static Friction Torque Compensation	0.0 - 100.0	%	0.0	●
F13.12	Static Friction Compensation	0.00 - 50.00	Hz	1.00	●
F13.13	Kinetic Friction Torque Compensation	0.0 - 100.0	%	0.0	●
F13.14 ~F13.1 7	Not Used				●
F13.18	Reverse speed limit	0~100	%	100	●
F13.19	Reverse torque limit	0~1		1	●
F14	Motor 2 Parameter Group				
F14.00	Motor Type	0: Common Induction Motor 1: Inverter Induction Motor 2: Permanent Magnet Synchronous Motor		0	○
F14.01	Motor Rated Power	0.10 - 650.00	kW	Up To Specific Model	○
F14.02	Motor Rated Voltage	50 - 2000	V	Up To Specific Model	○

EM500 Open-Loop Vector Control Inverter User Manual

F14.03	Motor Rated Current	0.01 - 600.00 (Motor Rated Power \leq 75kW) 0.1 - 6000.0 (Motor Rated Power \geq 75kW)	A	Up To Specific Model	○
F14.04	Motor Rated Frequency	0.01 - 600.00	Hz	Up To Specific Model	○
F14.05	Motor Rated Speed	1 - 60000	rpm	Up To Specific Model	○
F14.06	Motor Winding Connection	0: Y 1: Δ		Up To Specific Model	○
F14.07	Motor Rated Power Factor	0.600 - 1.000		Up To Specific Model	○
F14.08	Motor Efficiency	30.0 - 100.0	%	Up To Specific Model	○
F14.09	Stator Resistor of Induction Motor	1 - 60000 (Motor Rated Power \leq 75kW) 0.1 - 6000.0 (Motor Rated Power \geq 75kW)	m Ω	Up To Specific Model	○
F14.10	Rotor Resistor of Induction Motor	1 - 60000 (Motor Rated Power \leq 75kW) 0.1 - 6000.0 (Motor Rated Power \geq 75kW)	m Ω	Up To Specific Model	○
F14.11	Leakage Inductance of Induction Motor	0.01 - 600.00 (Motor Rated Power \leq 75kW) 0.001 - 60.000 (Motor Rated Power \geq 75kW)	mH	Up To Specific Model	○
F14.12	Mutual Inductance of Induction Motor	0.1 - 6000.0 (Motor Rated Power \leq 75kW) 0.01 - 600.00 (Motor Rated Power \geq 75kW)	mH	Up To Specific Model	○
F14.13	Idling Excitation Current of Induction Motor	0.1 - 600.00 (Motor Rated Power \leq 75kW) 0.1 - 6000.0 (Motor Rated Power \geq 75kW)	A	Up To Specific Model	○
F14.14	Induction Motor Field Weakening Factor 1	10.00 - 100.00	%	87.00	○

EM500 Open-Loop Vector Control Inverter User Manual

F14.15	Induction Motor Field Weakening Factor 2	10.00 - 100.00	%	80.00	○
F14.16	Induction Motor Field Weakening Factor 3	10.00 - 100.00	%	75.00	○
F14.17	Induction Motor Field Weakening Factor 4	10.00 - 100.00	%	72.00	○
F14.18	Induction Motor Field Weakening Factor 5	10.00 - 100.00	%	70.00	○
F14.19	Stator Resistor of Synchronous Motor	1 - 60000 (Motor Rated Power ≤ 75kW) 0.1 - 6000.0 (Motor Rated Power ≥75kW)	mΩ	Up To Specific Model	○
F14.20	d-Shaft Inductance of Synchronous Motor	0.01 - 600.00 (Motor Rated Power ≤ 75kW) 0.001 - 60.000 (Motor Rated Power ≥75kW)	mH	Up To Specific Model	○
F14.21	q-Shaft Inductance of Synchronous Motor	0.01 - 600.00 (Motor Rated Power ≤ 75kW) 0.001 - 60.000 (Motor Rated Power ≥75kW)	mH	Up To Specific Model	○
F14.22	Counter Electromotive Force of Synchronous Motor	10.0 - 2000.0 (Counter Electromotive Force of Rated Rotation Speed)	V	Up To Specific Model	○
F14.23	Initial Electric Angle of Synchronous Motor	0.0 - 359.9 (Synchronous motor enabled)			○
F14.24 - F14.33	Not Used				
F14.34	Motor Parameter Autotuning	0: No Autotuning 1: Stationary Autotuning of Induction Motor 2: Rotational Autotuning of Induction Motor 11: Stationary Autotuning of Synchronous Motor		0	○

EM500 Open-Loop Vector Control Inverter User Manual

		12: Rotational Autotuning of Synchronous Motor			
F14.35	Drive Control Mode of Motor 2	0: V/F control (VVF) 1: Sensorless Vector Control (SVC)		0	○
F14.36	Speed Proportional Gain ASR_P1	0.00 - 100.00		15.00	●
F14.37	Speed Integral Time Constant ASR_T1	0.000 - 30.000 0.000: No Integral	s	0.050	●
F14.38	Speed Proportional Gain ASR_P2	0.00 - 100.00		10.00	●
F14.39	Speed Integral Time Constant ASR_T2	0.000 - 30.000 0.000: No Integral	s	0.100	●
F14.40	Switching Frequency 1	0.00 - Switching Frequency 2	Hz	5.00	●
F14.41	Switching Frequency 2	Switching Frequency 1 - Maximum Frequency F00.16	Hz	10.00	●
F14.42	Speed Loop Anti-Saturation Factor	0.000 - 1.000		0.500	●
F14.43	Time Constant of Output Filter of Speed Loop	0.000 - 0.100	s	0.001	●
F14.44	Speed Control Slip Gain	50.00 - 200.00	%	100.00	●
F14.45	Speed control torque limit source selection	0: F06.10 and F06.11 1: AI1 2: AI2 3: AI3 4: AI4 (Expansion Card) 5: communication 6: maximum of AI2 and AI3 7: minimum of AI2 and AI3		0	○
F14.46	Upper Limit of Electric Torque for Speed Control	0.0 - 200.0	%	150.0	●
F14.47	Upper Limit of Brake Torque for Speed Control	0.0 - 200.0	%	150.0	●
F14.48	Excitation Current Proportional Gain	0.00 - 100.00		0.50	●

EM500 Open-Loop Vector Control Inverter User Manual

	ACR-P1				
F14.49	Excitation Current Integral Time Constant ACR-T1	0.00 - 600.00 0.00: No Integral	ms	10.00	●
F14.50	Torque Current Proportional Gain ACR-P2	0.00 – 100.00		0.50	●
F14.51	Torque Current Integral Time Constant ACR-T2	0.00 - 600.00 0.00: No Integral	ms	10.00	●
F14.52	Position Loop Gain	0.000 - 40.000		1.000	●
F14.53	SVC Control Mode at Zero Frequency	0: Brake 1: Normal 2: No output		2	○
F14.54	SVC Zero Frequency Band-Type Brake Current	50.0 - 400.0 (100.0=Idling Current)	%	100.0	○
F14.55	SVC Low Frequency Excitation Current	50.0 - 150.0 (100.0=Idling Current)	%	100.0	○
F14.56	Voltage Feedforward Gain	0 - 100	%	0	●
F14.57	Field Weakening Control Options of Synchronous Motor	0: Disabled 1: Direct Calculation 2: Automatic Adjustment		1	○
F14.58	Field Weakening Factor of Synchronous Motor	100.00 - 200.00	%	100.00	●
F14.59	Maximum Field Weakening Current of Synchronous Motor	0.0 - 150.0 (100.0= Motor Rated Current)	%	50.0	●
F14.60	Proportional Gain of Field Weakening Regulator of Synchronous Motor	0.00 - 10.00		0.50	●
F14.61	Integral Time of Field Weakening Regulator of	0.00 - 300.00	ms	10.00	●

EM500 Open-Loop Vector Control Inverter User Manual

	Synchronous Motor				
F14.62	MTPA Control Options of Synchronous Motor	0: Disabled 1: Enabled		0	○
F14.63	Gain of Autotuning at Initial Position	0 - 600	%	80	●
F14.64	Frequency of Injection Current at Low Frequency Range	0.00 - 100.00 (100.00= Motor Rated Frequency)	%	10.00	●
F14.65	Injection Current at Low Frequency Range	0.0 - 60.0 (100.0= Motor Rated Current)	%	20.0	●
F14.66	Low Frequency Range Regulator Gain of Injection Current	0.00 - 10.00		0.50	●
F14.67	Integral Time of Low Frequency Range Regulator of Injection Current	0.00 - 300.00	ms	10.00	●
F14.68	Frequency of Injection Current at High Frequency Range	0.00 - 100.00 (100.00= Motor Rated Frequency)	%	20.00	●
F14.69	Injection Current at High Frequency Range	0.0 - 30.0 (100.0= Motor Rated Current)	%	8.0	●
F14.70	High Frequency Range Regulator Gain of Injection Current	0.00 - 10.00		0.50	●
F14.71	Integral Time of High Frequency Range Regulator of Injection Current	0.00 - 300.00	ms	10.00	●
F14.72 - F14.73	Not Used				
F14.74	Angle	0.0 - 30.0	°	0.0	●

	Compensation Phase of Synchronous Motor				
F14.75	Angle Compensation Gain of Synchronous Motor	0.00 - 300.00	%	0.00	●
F14.76	Angle Compensation Filter Time of Synchronous Motor	0.000 - 30.000	s	0.100	●
F14.77	Motor 2 Acceleration/Deceleration Time	0: Same as Motor 1 1: Acceleration/Deceleration Time 1 2: Acceleration/Deceleration Time 2 3: Acceleration/Deceleration Time 3 4: Acceleration/Deceleration Time 4		0	○
F14.78	Motor 2 Maximum Frequency	1.00~600.00	Hz	50	●
F14.79	Motor 2 Upper Limit Frequency	Lower Limit Frequency F00.19 ~ Maximum Frequency F14.78	Hz	50	●
F14.80	Motor 2 V/F Curve Setting	0: Straight Line V/F 1: Multi-Dot Polyline V/F		0	●
F14.81	Motor 2 Multipoint VF Frequency Point F1	0.00~F14.83	Hz	0.50	●
F14.82	Motor 2 Multipoint VF Voltage Point F1	0.0~100.0 (100.0 = rated voltage)	%	1.0	●
F14.83	Motor 2 Multipoint VF Frequency Point F2	F14.81~F14.85	Hz	2.00	●
F14.84	Motor 2 Multipoint VF Voltage Point F2	0.0~100.0	%	4.0	●
F14.85	Motor 2 Multipoint VF Frequency Point F3	F14.83~motor rated frequency (reference frequency)	Hz	5.00	●
F14.86	Motor 2 Multipoint VF Voltage Point F3	0.0~100.0	%	10.0	●
F14.87	Stop Mode	0: Ramp-To-Stop 1: Coast-to-Stop		0	●

EM500 Open-Loop Vector Control Inverter User Manual

F15 Auxiliary Function Group					
F15.00	JOG Frequency	0.00 - Maximum Frequency F00.16	Hz	5.00	●
F15.01	JOG Acceleration Time	0.00 - 650.00 (F15.13=0) 0.0 - 6500.0 (F15.13=1) 0 - 65000 (F15.13=2)	s	5.00	●
F15.02	JOG Deceleration Time	0.00 - 650.00 (F15.13=0) 0.0 - 6500.0 (F15.13=1) 0 - 65000 (F15.13=2)	s	5.00	●
F15.03	Acceleration Time 2	0.00 - 650.00 (F15.13=0) 0.0 - 6500.0 (F15.13=1) 0 - 65000 (F15.13=2)	s	15.00	●
F15.04	Deceleration Time 2	0.00 - 650.00 (F15.13=0) 0.0 - 6500.0 (F15.13=1) 0 - 65000 (F15.13=2)	s	15.00	●
F15.05	Acceleration Time 3	0.00 - 650.00 (F15.13=0) 0.0 - 6500.0 (F15.13=1) 0 - 65000 (F15.13=2)	s	15.00	●
F15.06	Deceleration Time 3	0.00 - 650.00 (F15.13=0) 0.0 - 6500.0 (F15.13=1) 0 - 65000 (F15.13=2)	s	15.00	●
F15.07	Acceleration Time 4	0.00 - 650.00 (F15.13=0) 0.0 - 6500.0 (F15.13=1) 0 - 65000 (F15.13=2)	s	15.00	●
F15.08	Deceleration Time 4	0.00 - 650.00 (F15.13=0) 0.0 - 6500.0 (F15.13=1) 0 - 65000 (F15.13=2)	s	15.00	●
F15.09	Acceleration/Deceleration Time Reference Frequency	0: Maximum Frequency F00.16 1: 50.00Hz		0	○
F15.10	Automatic Switching between Acceleration and Deceleration Time	0: Disabled 1: Enabled		0	○
F15.11	Switching Frequency between Acceleration Time 1 and Acceleration Time 2	0.00 - Maximum Frequency F00.16	Hz	0.00	●
F15.12	Switching	0.00 - Maximum Frequency F00.16	Hz	0.00	●

	Frequency between Deceleration Time 1 and Deceleration Time 2				
F15.13	Acceleration/Deceleration Time Unit	0: 0.01s 1: 0.1s 2: 1s		0	○
F15.14	Hopping Frequency Point 1	0.00 - 600.00	Hz	600.00	●
F15.15	Frequency Hopping Range 1	0.00 - 20.00, 0.00: Disabled	Hz	0.00	●
F15.16	Hopping Frequency Point 2	0.00 - 600.00	Hz	600.00	●
F15.17	Frequency Hopping Range 2	0.00 - 20.00, 0.00: Disabled	Hz	0.00	●
F15.18	Hopping Frequency Point 3	0.00 - 600.00	Hz	600.00	●
F15.19	Frequency Hopping Range 3	0.00 - 20.00, 0.00: Disabled	Hz	0.00	●
F15.20	FAR Detection Bandwidth	0.00 - 50.00	Hz	2.50	○
F15.21	Output Frequency Detection Range FDT1	0.00 - Maximum Frequency F00.16	Hz	30.00	○
F15.22	FDT1 Hysteresis	-(Fmax-F15.21)~F15.21	Hz	2.00	○
F15.23	Output Frequency Detection Range FDT2	0.00 - Maximum Frequency F00.16	Hz	20.00	○
F15.24	FDT2 Hysteresis	-(Fmax-F15.23)~F15.23	Hz	2.00	○
F15.25	Analog input Level Detection ADT	0: AI1 1: AI2 2: AI3 3: AI4 (Expansion Card)		0	○
F15.26	ADT1 Analog input Level Detection ADT1	0.00 - 100.00	%	20.00	●
F15.27	ADT1 Hysteresis	0.00 - F15.26 (Monotonic Downward is active)	%	5.00	●
F15.28	Analog Input Level Detection ADT2	0.00 - 100.00	%	50.00	●

EM500 Open-Loop Vector Control Inverter User Manual

F15.29	ADT2 Hysteresis	0.00 - F15.28 (Monotonic Downward is active)	%	5.00	●
F15.30	Energy Consumption Brake	0: Disabled 1: Enabled		0	○
F15.31	Energy Consumption Brake Operation Voltage	110.0 - 140.0 (380V, 100.0=537V)	%	125.0 (671V)	●
F15.32	Brake Duty Ratio	20 - 100 (100 means that duty ratio is 1)	%	100	●
F15.33	Control Mode of Set Frequency Lower Than Lower Limit Frequency	0: Run at Lower Limit Frequency 1: Stop 2: Run at Zero Speed		0	○
F15.34	Fan Control	0: Run at Energization 1: Run at Start 2: Run at Intelligent Temperature Control		1	○
F15.35	Over modulation Intensity	1.00 - 1.10		1.05	●
F15.36	PWM Modulation Method Switching Options	0: Disabled (7 preset PWM modulation) 1: Enabled (5 preset PWM modulation)		0	○
F15.37	PWM Modulation Method	0.00 - Maximum Frequency F00.16	Hz	15.00	●
F15.38	Deadband Compensation Mode	0: Disabled 1: Compensation Mode 1 2: Compensation Mode 2		1	○
F15.39	Terminal Jog Priority	0: Disabled 1: Enabled		0	○
F15.40	Deceleration Time at Rapid Stop	0.00 - 650.00 (F15.13=0) 0.0 - 6500.0 (F15.13=1) 0 - 65000 (F15.13=2)	s	1.00	●
F15.41 ~ F15.43	Not Used				
F15.44	Phase Angle Adjustment Enabled	0: Enabled 1: Shut Down		0	●
F15.45	Power frequencyVariable frequency-Power frequency switching	0: Automatic 1: Manual		0	○

EM500 Open-Loop Vector Control Inverter User Manual

	mode				
F15.46	The Switching Time	0~1000	ms	100	○
F15.47	Phase card startup latency	0~1000	ms	100	○
F15.48	Direction of the phase Angle	0: Advanced 1: Lag		0	○
F15.49	Phase Angle Difference	0~180	°	0	●
F15.50	The current phase Angle error	-180~180	°	0	●
F15.51	The phase adjusting gain	0.00-600.00		1.00	×
F15.52	Phase-locked loop proportional gain	0.00~600.00		0.00	●
F15.53	Phase-locked loop integral gain	0.00~600.00		0.00	●
F15.54	Phase-locked loop filtering time	0.00~100.00	ms	0.50	●
F16	Customized Function Group				
F16.00	Industry Application	0: General models 1: Application of Water supply 2: Application of Air compressor 3: Application of Winding rolling		0	○
F16.01	Set Length	1~65535(F16.13=0) 0.1~6553.5(F16.13=1) 0.01~655.35(F16.13=2) 0.001~65.535(F16.13=3)	m	1000	●
F16.02	Pulse Count Per Meter	0.1 - 6553.5		100.0	●
F16.03	Set Count Value	F16.04 - 65535		1000	●
F16.04	Designated Count Value	1 - F16.03		1000	●
F16.05	Set Timed Running time	0.0 - 6500.0, 0.0: Disabled	min	0.0	●
F16.06	Agent Password	0 - 65535		0	○
F16.07	Set Accumulated Power-On Time Reach	0 - 65535, 0: Power-on Reach Time Protection Disabled	H	0	○
F16.08	Set Accumulated	0 - 65535, 0: Running time Reach	H	0	○

EM500 Open-Loop Vector Control Inverter User Manual

	Running time Reach	Protection Disabled										
F16.09	Factory Password	0 - 65535								XXXX X	●	
F16.10	The percentage of analog output when the count value is zero	0.00~100.00								%	0.00	○
F16.11	The percentage of analog output when the count value is the setting count value	0.00~100.00								%	100.00	○
F16.12	EC - A card slot expansion card type	0: No Expansion Card 1: Clock Card 2: Air compressor interface Card 3: Phase sequence phase detection card									0	○
F16.13	Set Resolution Of The Length	0: 1m 1: 0.1m 2: 0.01m 3: 0.001m									0	○
F17	Virtual I/O Function Group											
F17.00	VX1 Virtual Input Function	Same as numeric input terminal function of F02 group									0	○
F17.01	VX2 Virtual Input Function										0	○
F17.02	VX3 Virtual Input Function										0	○
F17.03	VX4 Virtual Input Function										0	○
F17.04	VX5 Virtual Input Function										0	○
F17.05	VX6 Virtual Input Function										0	○
F17.06	VX7 Virtual Input Function										0	○
F17.07	VX8 Virtual Input Function										0	○
F17.08	Positive/Negative Logic of Virtual Input	D7	D6	D5	D4	D3	D2	D1	D0		000 00000	○
		VX8	VX7	VX6	VX5	VX4	VX3	VX2	VX1			
		0: Positive Logic, Enabled at On/Disabled at Off										

EM500 Open-Loop Vector Control Inverter User Manual

		1: Negative Logic, Disabled at On/Enabled at Off										
F17.09	VX1 - VX8 Status Setting	D7	D6	D5	D4	D3	D2	D1	D0	000 00000	○	
		VX8	VX7	VX6	VX5	VX4	VX3	VX2	VX1			
		0: VXn Is Same as VYn Output 1: Status to be Set by F17.10										
F17.10	VX1 - VX8 Status Setting	D7	D6	D5	D4	D3	D2	D1	D0	000 00000	●	
		VX8	VX7	VX6	VX5	VX4	VX3	VX2	VX1			
		0: Disabled 1: Enabled										
F17.11	VX1 Effective Delay Time	0.000 - 30.000								s	0.000	●
F17.12	VX1 Ineffective Delay Time	0.000 - 30.000								s	0.000	●
F17.13	VX2 Effective Delay Time	0.000 - 30.000								s	0.000	●
F17.14	VX2 Ineffective Delay Time	0.000 - 30.000								s	0.000	●
F17.15	VX3 Effective Delay Time	0.000 - 30.000								s	0.000	●
F17.16	VX3 Ineffective Delay Time	0.000 - 30.000								s	0.000	●
F17.17	VX4 Effective Delay Time	0.000 - 30.000								s	0.000	●
F17.18	VX4 Ineffective Delay Time	0.000 - 30.000								s	0.000	●
F17.19	VY1 Virtual Output Function	Same as numeric output terminal function of F03 group									0	○
F17.20	VY2 Virtual Output Function										0	○
F17.21	VY3 Virtual Output Function										0	○
F17.22	VY4 Virtual Output Function										0	○
F17.23	VY5 Virtual Output Function										0	○
F17.24	VY6 Virtual Output Function										0	○
F17.25	VY7 Virtual Output Function										0	○

EM500 Open-Loop Vector Control Inverter User Manual

Function													
F17.26	VY8 Virtual Output Function									0	○		
F17.27	Positive/Negative Logic of Virtual Input	D7	D6	D5	D4	D3	D2	D1	D0	0: Positive Logic, Enabled at On/ Disabled at Off 1: Negative Logic, Disabled at On /Enabled at Off	000 00000	○	
		VY8	VY7	VY6	VY5	VY4	VY3	VY2	VY1				
F17.28	Virtual Output Terminal Control	D7	D6	D5	D4	D3	D2	D1	D0	0: To be determined by the status of X1 – X7(No VY8) 1: To be determined by the output function status	111 11111	○	
		VY8	VY7	VY6	VY5	VY4	VY3	VY2	VY1				
F17.29	VY1 Effective Delay Time	0.000 - 30.000								s	0.000	●	
F17.30	VY1 Ineffective Delay Time	0.000 - 30.000								s	0.000	●	
F17.31	VY2 Effective Delay Time	0.000 - 30.000								s	0.000	●	
F17.32	VY2 Ineffective Delay Time	0.000 - 30.000								s	0.000	●	
F17.33	VY3 Effective Delay Time	0.000 - 30.000								s	0.000	●	
F17.34	VY3 Ineffective Delay Time	0.000 - 30.000								s	0.000	●	
F17.35	VY4 Effective Delay Time	0.000 - 30.000								s	0.000	●	
F17.36	VY4 Ineffective Delay Time	0.000 - 30.000								s	0.000	●	
F17.37	Virtual Input Terminal Status	VX8	VX7	VX6	VX5	VX4	VX3	VX2	VX1	0: Disabled 1: Enabled	000 00000	×	
F17.38	Virtual Output Terminal Status	VY8	VY7	VY6	VY5	VY4	VY3	VY2	VY1	0: Disabled 1: Enabled	000 00000	×	
F18	Monitoring Parameter Group												
F18.00	Output Frequency	0.00 - Upper Limit Frequency							Hz	xxx	×		

EM500 Open-Loop Vector Control Inverter User Manual

F18.01	Set Frequency	0.00 - Maximum Frequency F00.16					Hz	xxx	×
F18.02	Not Used								
F18.03	Estimated Feedback Frequency	0.00 - Upper Limit Frequency					Hz	xxx	×
F18.04	Output Torque	-200.0 - 200.0					%	xxx	×
F18.05	Torque Setting	-200.0 - 200.0					%	xxx	×
F18.06	Output Current	0.00 - 650.00 (Motor Rated Power ≤ 75kW) 0.0 - 6500.0 (Motor Rated Power >75kW)					A	xxx	×
F18.07	Output Current Percentage	0.0 - 300.0 (100.0= Inverter Rated Current)					%	0.0	×
F18.08	Output Voltage	0.0 - 690.0					V	xxx	×
F18.09	DC bus Voltage	0 - 1200					V	xxx	×
F18.10	Simple PLC Running Times	0 - 10000						xxx	×
F18.11	Simple PLC Running Stage	1 - 15						xxx	×
F18.12	PLC Running Time of Present Stage	0.0 - 6000.0						xxx	×
F18.13	Not Used								
F18.14	Load Speed	0 - 65535					rpm	xxx	×
F18.15	UP/DOWN Offset Frequency	0.00 - 2*Maximum Frequency F00.16					Hz	xxx	×
F18.16	PID Setting	0.0 – PID Maximum Range						xxx	×
F18.17	PID Feedback	0.0 – PID Maximum Range						xxx	×
F18.18	Kilowatt-Hour Meter, MWh	0 - 65535					MWh	xxx	×
F18.19	Kilowatt-Hour Meter, kWh	0.0 - 999.9					kWh	xxx	×
F18.20	Output Power	0.00 - 650.00					kW	xxx	×
F18.21	Output Power Factor	-1.000 - 1.000						xxx	×
F18.22	Numeric Input Terminal Status 1	X5	X4	X3	X2	X1		xxx	×
		0/1	0/1	0/1	0/1	0/1			
F18.23	Numeric Input	A13	A12	A11	X7	X6		xxx	×

EM500 Open-Loop Vector Control Inverter User Manual

	Terminal Status 2	0/1	0/1	0/1	0/1	0/1			
F18.24	Numeric Input Terminal Status 3	AI4	X11	X10	X9	X8		xxx	×
		0/1	0/1	0/1	0/1	0/1			
F18.25	Output Terminal Status	Y3	R2	R1	Y2	Y1		xxx	×
		0/1	0/1	0/1	0/1	0/1			
F18.26	AI1	0.0 - 100.0				%	xxx	×	
F18.27	AI2	0.0 - 100.0				%	xxx	×	
F18.28	AI3	0.0 - 100.0				%	xxx	×	
F18.29	AI4	-100.0 - 100.0				%	xxx	×	
F18.30	Communication Setting	-100.0 - 100.0				%	xxx	×	
F18.31	High-Frequency Pulse Input Frequency: kHz	0.00 - 100.00				kHz	xxx	×	
F18.32	High-Frequency Pulse Input Frequency: Hz	0 - 65535				Hz	xxx	×	
F18.33	Count Value	0 - 65535					xxx	×	
F18.34	Actual Length	0 - 65535				m	xxx	×	
F18.35	Remaining Time of Timed Run	0.0 - 6500.0				min	xxx	×	
F18.36	Position of Rotor of Synchronous Motor	0.0 - 359.9				°	xxx	×	
F18.37	Rotary Transformer Position	0 - 4095					xxx	×	
F18.38	Motor Temperature	0 - 200				°C	xxx	×	
F18.39	VF Separation Target Voltage	0 - 690				V	xxx	×	
F18.40	VF Separation Output Voltage	0 - 690				V	xxx	×	
F18.41 - F18.50	Not Used								

F18.51	PID Output	-100.0~100.0	%	XXX	×
F18.52 - F18.59	Not Used				
F18.60	Inverter temperature	-40~200	°C	0	×
F19	Fault Record Group				
F19.00	Last Fault Type	<i>0</i> : No Fault <i>5C</i> : Output Short Circuit Protection <i>HOC</i> : Instantaneous Overcurrent <i>HOU</i> : Instantaneous Overvoltage <i>SOC</i> : Stable Overcurrent <i>SOV</i> : Stable Overvoltage <i>SUV</i> : Stable Undervoltage <i>ILP</i> : Input Phase Loss <i>OLP</i> : Output Phase Lose <i>OL</i> : Inverter Overload <i>OH</i> : Inverter Overheating Protection <i>E11</i> : Parameter Setting Conflict <i>E12</i> : Motor Overheating <i>E13</i> : Motor Overload <i>E14</i> : External Fault <i>E15</i> : Inverter EEPROM Fault <i>E16</i> : Communication Abnormality <i>E17</i> : Temperature Sensor Abnormality <i>E18</i> : Soft Start Relay Off <i>E19</i> : Current Detection Circuit Abnormality <i>E20</i> : Stall Fault <i>E21</i> : PID Feedback Disconnection <i>E22</i> : Not Used <i>E23</i> : Keypad EEPROM Fault <i>E24</i> : Parameter Autotuning Abnormality <i>E25</i> : Not Used <i>E26</i> : Offload Protection <i>E27</i> : Accumulated Power-On Time		0	×

		<p>Reach</p> <p>E28: Accumulated Running time Reach</p> <p>E29: Internal Communication Fault</p> <p>E30 - E32: Not Used</p> <p>E33: CANopen Communication Overtime</p> <p>E34: DeviceNET without Network Power Supply</p> <p>E35: DeviceNET BUS-OFF</p> <p>E36: DeviceNET MACID Detection Failure</p> <p>E37: DeviceNET IO Communication Overtime</p> <p>E38: DeviceNET IO Mapping Error</p> <p>E39: Profibus-DP Parameterization Data Error</p> <p>E40: Profibus-DP Configuration Data Error</p> <p>E41: Profibus-DP IO Disconnection</p> <p>E42: Not Used</p> <p>E43: Material supply disruptions Error</p> <p>E44: Winding traverse Error</p> <p>E45: Air pressure over voltage Error</p> <p>E46: Air pressure feedback Disconnection</p> <p>E47: Oil Temperature Over-temperature Error</p> <p>E48: Oil Temperature Feedback Disconnection</p> <p>E49: Motor Over-temperature Error</p> <p>E50: Motor Temperature Feedback Disconnection Error</p> <p>E51: It's Time For Mechanical Maintenance</p> <p>E52~E55: Not Used</p> <p>E56: Pump Error</p>			
--	--	---	--	--	--

EM500 Open-Loop Vector Control Inverter User Manual

		E57: Pipe networks Overpressure E58: Pipe networks Undervoltage E59: water supply tank Water shortage E60: Not Used E61: CANSinec Communication Timeout			
F19.01	Output Frequency at Fault	0.00 - Upper Limit Frequency	Hz	0.00	×
F19.02	Output Current at Fault	0.00 - 650.00 (Motor Rated Power ≤ 75kW) 0.0 - 6500.0 (Motor Rated Power >75kW)	A	0.00	×
F19.03	Bus Voltage at Fault	0 - 1200	V	0	×
F19.04	Running Mode at Fault	0: Not Running 1: Forward Acceleration 2: Reverse Acceleration 3: Forward Deceleration 4: Reverse Deceleration 5: Forward Constant Speed 6: Reverse Constant Speed		0	×
F19.05	Working Time at Fault		h	0	×
F19.06	Last Fault Type	See F19.00 Parameter Description		0	×
F19.07	Output Frequency at Fault		Hz	0.00	×
F19.08	Output Current at Fault		A	0.00	×
F19.09	Bus Voltage at Fault		V	0	×
F19.10	Running Mode at Fault	See F19.00 Parameter Description		0	×
F19.11	Working Time at Fault		h	0	×
F19.12	Types of Last Two Faults	See F19.04 Parameter Description		0	×
F19.13	Output Frequency at Fault		Hz	0.00	×
F19.14	Output Current at Fault		A	0.00	×
F19.15	Bus Voltage at Fault		V	0	×

F19.16	Running Mode at Fault	See F19.04 Parameter Description		0	×
F19.17	Working Time at Fault		h	0	×
F25	Application of water supply basic groups				
F25.00	Run Mode Selection	0: The basic mode of constant pressure water supply 1: Not Used		0	○
F25.01	Not Used				
F25.02	Upper Limit Pressure	F25.03~F09.03	% /MP a	100.0	○
F25.03	Lower Limit Pressure	0.1~F25.02	% /MP a	0.1	○
F25.04	Overpressure alarm pressure of pipe networks	0.1~F09.03	% /MP a	100.0	●
F25.05	Under-voltage alarm pressure of pipe networks	0.1~F09.03	% /MP a	0.1	●
F25.06	overpressure And under-voltage protection action time	0~3600	s	500	●
F25.07 ~ F25.15	Not Used				
F25.16	H Pump Definition	0: No H Pump 1: H Pump is Sewage pump 2: H Pump is primary pump(Only when F25.00=0)		0	○
F25.17	I Pump Definition	0: No I Pump 1: I Pump is Auxiliary(Sleep) pump 2:I Pump is Emergency pump (Only when F25.00=0)		0	○
F25.18	Not Used				
F25.19	Electromagnetic switch switching time	0.1~5.0	S	0.5	○

EM500 Open-Loop Vector Control Inverter User Manual

F25.20 ~ F25.28	Not Used				
F25.29	Pump Timing Rotation cycle	0~9999	h	0	●
F25.30	Rapid pump rotation function verification	0: The normal rotation clock 1: Rotation clock Speed Up		0	●
F25.31	The timing pump switch signal output ahead of time	0.0~1000.0	S	10.0	●
F25.34 ~ F25.37	Not Used				
F25.38	Water Supply Pool the water level measuring function	0: Disabled 1: Switch quantity detection 2: Analog quantity detection		0	○
F25.39	The water level signal analog input channel selection	0: AI1 1: AI2 2: AI3 3: AI4 4: HDI 5: Communications input		2	○
F25.40	Upper Limit water level analog level	0.0~100.0	%	60.0	●
F25.41	Lower Limit water level analog level	0.0~100	%	40.0	●
F25.42	Water shortage level analog level	0.0~100.0	%	20.0	●
F25.43	Non-normal standby pressure	F25.03~F09.01	%/ MPa	0.1	○
F25.44	Sewage pool water level detection function	0: Disabled 1: Enabled		0	○
F25.45	Inverter fault handling	0: All Stop 1: Maintain the status quo.		0	○
F25.46	Feedback disconnection handling	0: All Stop 1: Maintain the status quo.		0	○
F25.47	Pipe network overpressure alarm	Ones Place: Overpressure alarm selection		10	○

	handling	0: Error 1: Alarm Tens Place:Switching mode under overpressure 0: Not Used 1:Scram standby			
F25.48 ~ F25.60	Not Used				
F25.61	Primary pump current running time	0~65535	h		×
F25.62	Primary pump total running time	0~65535	h		●
F25.63	Standby pump current running time	0~65535	h		×
F25.64	Standby pump total running time	0~65535	h		●
F25.65 ~ F25.74	Not Used				
F25.75	Reset the current running time	0: Not Used 1: Reset		0	○
F26	Application of water supply advanced group				
F26.00	The Gregorian calendar year Set	2000~2099		XXX	○
F26.01	The Gregorian calendar Dater Set	01~12(Month). 01~31(Day)		XXX	○
F26.02	The Gregorian calendar Week	0~6 0: Sunday		XXX	○
F26.03	Real time setting	00~23(Hour).00~59(Minutes)		XXX	○
F26.04	Conventional Day timing choice of water supply	0: Disabled 1: Enabled		0	○
F26.05	T1 Start time	00.00~23.59		0.00	○
F26.06	Pressure at time T1	F25.03~F25.02	% /MP a	0.1	○
F26.07	T2 Start time	T1~23.59		0.00	○
F26.08	Pressure at time T2	F25.03~F25.02	% /MP	0.1	○

EM500 Open-Loop Vector Control Inverter User Manual

			a		
F26.09	T3 Start time	T2~23.59		0.00	○
F26.10	Pressure at time T3	F25.03~F25.02	% /MP a	0.1	○
F26.11	T4 Start time	T3~23.59		0.00	○
F26.12	Pressure at time T4	F25.03~F25.02	% /MP a	0.1	○
F26.13	T5 Start time	T4~23.59		0.00	○
F26.14	Pressure at time T5	F25.03~F25.02	% /MP a	0.1	○
F26.15	T6 Start time	T5~23.59		0.00	○
F26.16	Pressure at time T6	F25.03~F25.02	% /MP a	0.1	○
F26.17	Unconventional Day timing choice of water supply	0: Saturday And Sunday effective 1: Effective on Sunday, Saturday is invalid 2: Saturday and Sunday is invalid		0	○
F26.18	T1 Start time	00.00~23.59		0.00	○
F26.19	Pressure at time T1	F25.03~F25.02	% /MP a	0.1	○
F26.20	T2 Start time	T1~23.59		0.00	○
F26.21	Pressure at time T2	F25.03~F25.02	% /MP a	0.1	○
F26.22	T3 Start time	T2~23.59		0.00	○
F26.23	Pressure at time T3	F25.03~F25.02	% /MP a	0.1	○
F26.24	T4 Start time	T3~23.59		0.00	○
F26.25	Pressure at time T4	F25.03~F25.02	% /MP a	0.1	○
F26.26	T5 Start time	T4~23.59		0.00	○
F26.27	Pressure at time T5	F25.03~F25.02	% /MP	0.1	○

			a		
F26.28	T6 Start time	T5~23.59		0.00	○
F26.29	Pressure at time T6	F25.03~F25.02	% /MP a	0.1	○
F27	Winding rolling application				
F27.00	The application of macro	0: Winding mode 1: Unwinding mode 2: Wire drawing mode 3: Straight wire drawing machine mode		0	○
F27.01	Feedforward Gain Effect channel	0: Feedforward Gain *Given source B 1: Feedforward Gain *Given source A 2: Feedforward Gain *10V		1	○
F27.02	Feedforward Gain input mode	0: Feedforward gain invariability 1: 0.00~Upper Limit feedforward gain 2: - Upper Limit feedforward gain~+ Upper Limit feedforward gain		1	○
F27.03	Feedforward Control	Ones Place: Feedforward reset option 0: Automatic reset 1: Terminal reset Tens Place: Feedforward power off and parking choice 0: Power off saved 1: Power off unsaved		10	○
F27.04	Upper Limit feedforward gain	0.00~500.00	%	500.00	○
F27.05	Feedforward initial gain	0.00~500.00	%	50.00	●
F27.06	feedforward gain filtering time	0~1000	ms	0	●
F27.07	Feedforward range 0	0.00~ Feedforward range 1	%	4.00	●
F27.08	Feedforward range 1	Feedforward range 1~ Feedforward range 2	%	12.00	●
F27.09	Feedforward range 2	Feedforward range 2~ Feedforward range 3	%	23.00	●
F27.10	Feedforward range 3	Feedforward range 3~ Feedforward range 4	%	37.00	●
F27.11	Feedforward range 4	Feedforward range 4~ Feedforward range 5	%	52.00	●
F27.12	Feedforward range 5	Feedforward range 5~100.00	%	72.00	●

EM500 Open-Loop Vector Control Inverter User Manual

F27.13	Soft start incremental	0.00~50.00	%/s	0.60	●
F27.14	feedforward increment 1	0.00~50.00	%/s	0.11	●
F27.15	feedforward increment 2	0.00~50.00	%/s	0.30	●
F27.16	feedforward increment 3	0.00~50.00	%/s	0.75	●
F27.17	feedforward increment 4	0.00~50.00	%/s	1.55	●
F27.18	feedforward increment 5	0.00~50.00	%/s	4.00	●
F27.19	feedforward increment 6	0.00~50.00	%/s	11.00	●
F27.20	Material supply disruptions control way	<p>Ones Place:Material supply disruptions detection mode 0: Automatic detection 1: external signal</p> <p>Tens Place:Material supply disruptions detection control 0: Detect when output is greater than the lower limit of material supply interrupt detection 1: No detection</p> <p>hundreds place: Material supply disruptions process mode 0:Only Error terminal act 1:Parking time delay and Err 2:Material supply disruptions Error 3.Material supply disruption error resumed automatically</p> <p>Thousands place:Brake mode 0:Mode 0 1:Mode 1</p> <p>Myriad bit: Unwinding reverse mode 0:unrestricted speed 1: Reverse speed limit as per F27.24</p>		11211	○
F27.21	Material supply disruptions Detection delay	0.0~10.0	s	6.0	●

F27.22	The lower limit of material supply interruption detection when parking	0.00~60.00	Hz	5.00	●
F27.23	Continuous running time after the material supply disruptions	0.0~60.0	s	10.0	●
F27.24	Continuous running Frequency after the material supply disruptions	0.00~Fmax	Hz	5.00	●
F27.25	Brake signal output frequency	0.00~Fup	Hz	2.50	●
F27.26	Brake signal duration	0.0~100.0	s	5.0	●
F27.27	Winding traverse detection minimum frequency	0.00~20.00	Hz	10.00	●
F27.28	Winding traverse signal invalid judge time	0.1~20.0	s	10.0	●
F27.29	Winding traverse signal effective judge time	0.1~20.0	s	2.0	●
F27.30	Material supply disruptions Detection filtering time	1~100	s	5	●
F27.31 ~ F27.35	Not Used				
F27.36	The current feedforward gain value	-500.0~500.0	%	XXX	×
F28	Air Compressor Application				
F28.00	The application of macro	0: Application of air compressor all-in-one macros		0	○
F28.01	Air compressor	0: Local		0	○

EM500 Open-Loop Vector Control Inverter User Manual

	start-stop way	1: Remote control			
F28.02	Loading way	0: Automatic 1: Manual		0	○
F28.03	Loading Lower limit Frequency	0.00~Fup	Hz	25.00	●
F28.04	Manual loading control command	0: reset 0 uninstal 1: To 1 Load		0	●
F28.05	Dormancy Delay	10~7200	s	1200	●
F28.06	Unloading operation frequency	0.00~Fup	Hz	20.0	●
F28.07	Shutdown and restart delay time	1~300	s	60	●
F28.08	Shutdown delay time	0~60000	s	5	●
F28.09	Maximum pressure range	0.5~25.00	MPa	1.60	○
F28.10	Pressure feedback selection	0: AI1 1: AI2 2: AI3 3: AI4 4: HDI		0	○
F28.11	Pressure Digital given	0.00~Upper Limit Pressure value	MPa	0.80	●
F28.12	Early-warning pressure	Pressure Digital given~ Warning pressure	MPa	0.98	●
F28.13	Warning pressure	Early-warning pressure~ Maximum pressure range	MPa	1.00	●
F28.14	Pressure proportional gain GP	0.00~100.00		5.00	●
F28.15	Pressure integral time GTi	0.000~60.000, 0.000: No Integral	s	10.000	●
F28.16	Pressure differential time GTd	0.000~60.000	ms	0.000	●
F28.17	Pressure integral action range	0.00~100.00	%	100.00	●
F28.18	Pressure Regulation Upper Limit	0.00~100.00	%	100.00	●
F28.19	Pressure regulation Lower Limit	0.00~100.00	%	25.00	●
F28.20	lower Limit	0.00~ Upper Limit pressure value	MPa	0.75	●

EM500 Open-Loop Vector Control Inverter User Manual

	pressure value				
F28.21	Upper Limit pressure value	lower Limit pressure value~ Maximum pressure range	MPa	0.85	●
F28.22	Pressure limit deviation	0.00~100.00	%	0.00	●
F28.23	Pressure disconnection detection threshold	0.00~ Maximum pressure range	MPa	0.08	○
F28.24	Pressure disconnection detection Time	0.0~6000.0, 0.0 :The Function is Disabled	s	0.0	●
F28.25	sensor selection	Ones Place:oil temperature sensor 0: General channel 1: Interface card Tens Place: motor sensor 0: General channel 1: PT100 2: KTY84-130/150 3: PTC130/150 hundreds place: Air pressure sensor 0: General channel 1: Interface card		101	○
F28.26	Maximum temperature range	60.0~160.0	°C	125.0	○
F28.27	Temperature feedback selection	0: AI1 1: AI2 2: AI3 3: AI4 4: HDI		1	○
F28.28	Temperature Digital given	0.0~ Maximum temperature range	°C	80.0	●
F28.29	Early-warning Temperature	Temperature Digital given~ Warning Temperature	°C	105.0	●
F28.30	Warning Temperature	Early-warning Temperature~ Maximum temperature range	°C	110.0	●
F28.31	Temperature proportional gain GP	0.00~100.00		5.00	●
F28.32	Temperature integral time GTi	0.000~60.000, 0.000: No Integral	s	10.000	●
F28.33	Temperature	0.000~60.000	ms	0.000	●

	differential time GTd				
F28.34	Temperature integral action range	0.00~100.00	%	100.00	●
F28.35	Temperature Regulation Upper Limit	0.00~100.00	%	100.00	●
F28.36	Temperature regulation Lower Limit	0.00~100.00	%	100.00	●
F28.37	Fan stop temperature	0.00~ Maximum temperature range	°C	70.0	●
F28.38	Stopping temperature running time	10~7200	s	1200	●
F28.39	Fan start delay time	1~300	s	10	●
F28.40	Temperature limit deviation	0.00~100.00	%	0.00	●
F28.41	Temperature disconnection detection threshold	0.0~ Maximum temperature range	°C	8.0	○
F28.42	Temperature disconnection detection Time	0.0~6000.0, 0.0 :The Function is Disabled	s	0.0	●
F28.43	Motor Temperature feedback selection	0: AI1 1: AI2 2: AI3 3: AI4 4: HDI		2	○
F28.44	Motor overheating threshold	25.0~200.0	°C	110.0	○
F28.45	Motor PTC disconnection detection threshold	0.0~50.0	°C	8.0	○
F28.46	Motor PTC disconnection detection Time	0.00~6000.0, 0.0:The Function is Disabled	s	0.0	●
F28.47	Oil filter using time presets	0~9000	h	4500	●
F28.48	oil separator using time presets	0~9000	h	4500	●

EM500 Open-Loop Vector Control Inverter User Manual

F28.49	Air filter using time presets	0~9000	h	4500	●
F28.50	Lubricating oil using time presets	0~9000	h	4500	●
F28.51	Grease using time presets	0~9000	h	4500	●
F28.52	Preset alarm delay time	0~100	h	10	●
F28.53	The Power meter timing reset	0: No Used 1: Reset		0	●
F28.54	Inching loading delay	0~60	s	3	○
F28.55	Protection block	First place: mechanical maintenance time up protection Second place: Pressure overrun protection Third place: Pressure feedback disconnection protection Fourth place: Temperature overrun protection Fifth place: Temperature feedback disconnection protection Sixth place: Not Used Seventh place: The motor feedback disconnection protection Eighth place: Not Used From right to left (0- No shield 1-shield)		0000 0001	○
F28.56 ~ F28.65	Not Used				
F28.66	JZ Multi-function set	See the output terminals function table		49	○
F28.67	BJ Multi-function set	See the output terminals function table		7	○
F28.68	Interface card Positive and negative logic setting	0: JT Normally closed 1: JT Normally open		0	○
F28.69	Sensor offset curve setting	Ones Place: Interface board oil temperature		120	○

		0: Curve 1 1: Curve 2 2: Curve 3 3: Curve 4 Tens Place: Interface board Motor temperature 0: Curve 1 1: Curve 2 2: Curve 3 3: Curve 4 hundreds place: Interface board pressure 0: Curve 1 1: Curve 2 2: Curve 3 3: Curve 4			
F28.70	Add and subtract load state	0: Unloading state 1: Loading state 2: Dormant state		0	×
F28.71	Time Error query	First place: Oil filter time Second place: Oil separator time Third place: Air filter time Fourth place: Lubricating oil time Fifth place: Grease time From right to left		00000	×
F28.72	Stop delay remaining time	0~60000	s	XXX	×
F28.73	Continuous no-load running time	0~60000	s	XXX	×
F28.74	Stop and restart remaining time	0~60000	s	XXX	×
F28.75	The electricity meter: MWh	0~65535	Mwh	XXX	×
F28.76	The electricity meter: KWh	0~65535	KWh	XXX	×
F28.77	The Running Time	0~60000	h	XXX	×
F28.78	Pressure feedback	0.00~600.00	MPa	0	×
F28.79	oil passage temperature feedback	0.0~200.0	°C	0	×
F28.80	Motor temperature	0.0~200.0	°C	0	×

EM500 Open-Loop Vector Control Inverter User Manual

	feedback																				
F28.81	Oil filter actual use time	0~9500	h	XXX	●																
F28.82	Oil separator actual use time	0~9500	h	XXX	●																
F28.83	Air filter actual use time	0~9500	h	XXX	●																
F28.84	Lubricating oil actual use time	0~9500	h	XXX	●																
F28.85	Grease actual use time	0~9500	h	XXX	●																
F28.86	Load running time	0~65535	h	XXX	●																
F28.87	unload running time	0~65535	h	XXX	●																
F28.88	The cumulative watt hour meter: MWh	0~65535	MWh	XXX	●																
F28.89	The cumulative watt hour meter: KWh	0.0~999.9	KWh	XXX	●																
F28.90	Cumulative operation time	0~60000	h	XXX	●																
F28.91	Interface card Terminal function query	<table border="1" style="width: 100%; text-align: center;"> <tr> <td>7</td><td>6</td><td>5</td><td>4</td><td>3</td><td>2</td><td>1</td><td>0</td> </tr> <tr> <td>*</td><td>*</td><td>*</td><td>*</td><td>*</td><td>B J</td><td>JZ</td><td>JT</td> </tr> </table> <p>0: Disabled 1: Abled JT: Emergency stop status is displayed JZ: Display JZ terminal state of Interface card BJ: Display BJ terminal state of Interface card</p>	7	6	5	4	3	2	1	0	*	*	*	*	*	B J	JZ	JT		XXX	×
7	6	5	4	3	2	1	0														
*	*	*	*	*	B J	JZ	JT														
F28.92	Air pressure Input monitoring	-10000~10000		XXX	×																
F28.93	Oil temperature input monitoring	-10000~10000		XXX	×																
F28.94	Motor temperature input monitoring	-10000~10000		XXX	×																

7. Parameter Description

7.1 F00 Group: General Parameter

No.	Function	Range	Unit	Default	Type
F00.01	Control Mode of Motor 1	0: V/F control (VVF) 1: Sensorless Vector Control (SVC)		0	○

F00.01=0: V/F control (VVF)

Inverter is applicable for the occasions when multiple motors are driven by a single inverter or it is not required for quick response or high precision.







F00.01=1: Sensorless Vector Control (SVC)

Open loop vector control mode is usually applied to high-performance control occasions and one inverter can drive one motor only. The loads include machine tool, centrifuge, wire-drawing machine and injection moulding machine.

- 
 1. Before running in the vector control mode, inverter needs to autotune motor parameters to obtain correct motor parameters and enhance the control performance.
 2. While using the vector control mode, inverter can only have one motor. Motor and inverter shall not be much different from each other in capacity, otherwise the control performance may decrease or the system cannot work normally.

No.	Function	Range	Unit	Default	Type
F00.02	Command Source	0: Keypad Control (LOC/REM indicator on) 1: Terminal Control (LOC/REM indicator off) 2: Communication Control (LOC/REM indicator flickers)		0	○

F00.02=0: Keypad Control (LOC/REM indicator on)

The start and stop of inverter will be controlled with ,  and  of keypad. Under no fault, press  to enter jog running mode or press  to enter running mode. When the green LED above the  button is always on, it means that inverter is running; when the green LED above the  button flickers, it means that inverter is in the ramp-to-stop status.

No matter whether the reference input of the control mode is speed or torque, inverter always runs at jog input speed control mode as long as jog is enabled.

F00.02=1: Terminal Control (LOC/REM indicator off)

The start/stop control terminal defined through F02.00 - F02.06 controls the start and stop of inverter; the detailed configurations of the terminal control are defined through F00.03.

F00.02=2: Communication Control (LOC/REM indicator flickers)

The host controller controls inverter to start and stop through RS485 communication interface. See 7000H in 12.3.4 Allocation of Register Address for detail.



The final command source is also determined by either “24: Switch Run Command to Keypad” or “25: Switch Run Command to Communication”. When the input function “24: Switch Run Command to Keypad” is enabled, present command source is “Keypad Control”. When the input function “25: Switch Run Command to Communication” is enabled, present command source is “Communication Control”. Otherwise, the final command source is determined through F00.02.

No.	Function	Range	Unit	Default	Type
F00.03	Terminal Control Mode Options	0: Terminal RUN for running, Forward/Reverse (F/R) 1: Terminal RUN for forward, F/R reverse 2: Terminal RUN for forward, Xi stop, F/R reverse 3: Terminal RUN for running, Xi stop Forward/Reverse (F/R)		0	○

Terminal RUN: $X_i=1$, Run Terminal “RUN”

Terminal Forward/Reverse (F/R): $X_i=2$, Direction R/F

There are two terminal control modes, 2-wire sequence and 3-wire sequence.

2-Wire Sequence:

F00.03=0: Terminal RUN, Forward/Reverse (F/R)

ON/OFF of terminal RUN controls the start and stop of inverter and OFF/ON of terminal F/R controls the forward/reverse of inverter; if F00.21 is set as 1 and reverse is prohibited, terminal F/R is disabled. By selecting the ramp-to-stop for the stop mode, the logic diagram is shown in Figure 7-1 (b).

F00.03=1: Terminal RUN forward, F/R reverse

ON/OFF of terminal RUN controls the forward running and stop of inverter and ON/OFF of terminal F/R controls the reverse and stop of inverter. If terminals RUN and F/R are on, inverter stops. If reverse is prohibited, terminal F/R is disabled. When selecting the ramp-to-stop, the control logic of inverter Forward/Reverse is shown in Figure 7-1 (d).

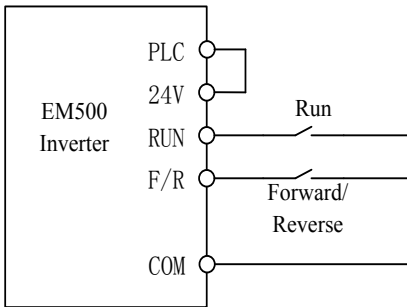

(a) F00.03=0
2-Wire Sequence Wiring Diagram

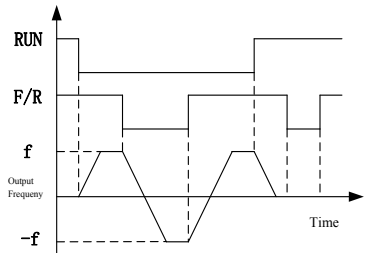

(b) F04.19=0, F00.03=0
Forward/Reverse Running Sequence

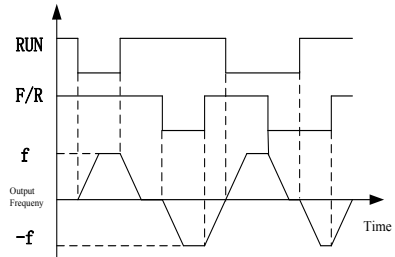
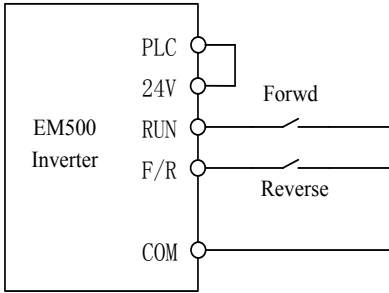

(c) F00.03=1

(d) F04.19=0, F00.03=1

2-Wire Sequence Wiring Diagram

Forward/Reverse Running Sequence

Figure 7-1 2-Wire Sequence



When selecting F00.03 start/stop option as 0 or 1, either pressing  or using an external terminal stop command can stop inverter, even if terminal RUN is on. At this time, terminal RUN should be disabled and then enabled, it can once again enter running state.

3-Wire Sequence:

F00.03=2: Terminal RUN forward, Xi stop, F/R reverse

RUN is a NO forward running button and F/R is a NO reverse running button; both of them are effective at pulse edge; Xi is a NC stop button and enabled at the level. Under running mode, pressing Xi can stop inverter. When stop mode is set as F04.19=0 Ramp-To-Stop, the logic diagram is shown in Figure 7-2 (b). Xi is a terminal among X1 - X7 and defined as 3-Wire Sequence Run/Stop Control.

F00.03=3: Terminal RUN, Xi stop, Forward/Reverse (F/R)

RUN is a NO running button, and will be on at pulse edge (F/R is on at level). F/R is a forward/reverse switching button (inverter forwards when F/R is disabled, and inverter reverses when F/R is enabled). Xi is a NC stop button, and on at the level. When the stop mode is set as F04.19=0 Ramp-To-Stop, the logic sequence is shown in Figure 7-2 (d).

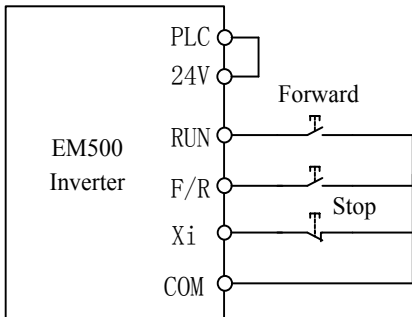

(a) F00.03=2

3-Wire Sequence Wiring Diagram

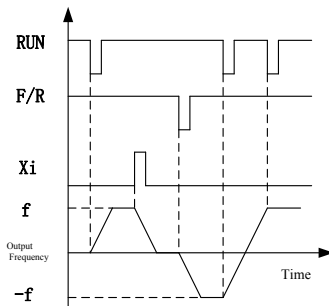

(b) F04.19=0, F00.03=2

Forward/Reverse Running Sequence

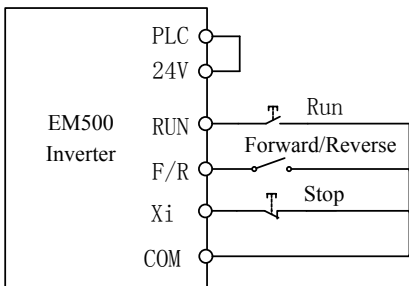

(c) F00.03=3

3-Wire Sequence Wiring Diagram

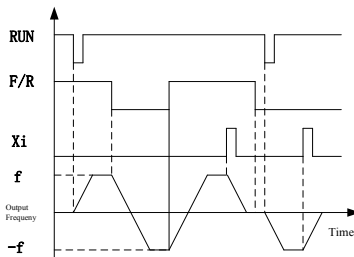

(d) F04.19=0, F00.03=3

Forward/Reverse Running Sequence

Figure 7-2 3-Wire Sequence



The 3-wire sequence of EM500 inverter conforms to traditional electrical control method. Please use buttons and knobs as shown in the diagram correctly so as to avoid malfunctions.

No.	Function	Range	Unit	Default	Type
F00.04	Main Frequency Source A	0: Numeric Frequency Setting F00.07 1: AI1 2: AI2		0	○

		3: AI3 4: AI4 (Expansion Card) 5: High-Frequency Pulse Input (X7) 6: Main Frequency Communication Percentage Setting 7: Direct Main Frequency Communication Setting 8: digital Potentiometer			
--	--	---	--	--	--

F00.04=0: Numeric Frequency Setting F00.07

Main frequency source A is determined through numeric frequency setting F00.07.

F00.04=1: AI1**F00.04=2: AI2****F00.04=3: AI3****F00.04=4: AI4 (Expansion Card)**

Main frequency source A is determined through AI (percentage) * F00.16.

AI1 is 0 V to 10 V voltage input;

AI2/AI3 can be either 0 V to 10 V voltage input or 0 mA to 20 mA current input.

Specific options can be made through the terminal of terminal plate S4/S5.

AI4 is -10 V to 10 V voltage input and IO expansion card (EC-IO-A1) of SINEE is required.

The percentage corresponding to the input of AI terminal is set through F02.31 - F02.36. 100.00% corresponds to the value set through F00.16 (Maximum Frequency).

F00.04=5: High-Frequency Pulse Input (X7)

Main frequency source A is determined through HDI (percentage) * F00.16.

X7 can also be used as high-frequency pulse input (terminal function F02.06 shall be set as "40: Pulse Input"), with set frequency range of 0.00 to 100.00 kHz and set voltage range of 12 to 48 V. The percentage of terminal input pulse frequency shall be set through F02.06 - F02.29 and 100.00% is the percentage set through F00.16 (Maximum Frequency).

F00.04=6 or 7: Main Frequency Setting by Communication

For master-slave communication (F10.05=1) and the inverter is slave (F10.06=0) main frequency source A is set as “700FH (Main Frequency Setting by Communication) * F00.16 (Maximum Frequency)* F10.08 (Receiving Proportionality Factor of Slave)”. The range of 700FH is -100.00% to 100.00%. See Table 12-2 for details.

For general communication (F10.05=0):

a) F00.04=6 Main Frequency Communication Percentage Setting. Main frequency source A is set as “7001H (communication setting of main channel frequency A) * F00.16 (Maximum Frequency)”.

b) F00.04=7 Main Frequency Communication Direct Setting. Main frequency source A is set as “7015H (communication setting of main channel frequency A)”.

The range of 7001H is -100.00% to 100.00%. The range of 7015H is 0.00 to F00.16 (Maximum Frequency). See Table 12-2 for details.

F00.04=8: digital Potentiometer

For speed mode main frequency source A is set as digital Potentiometer. F12.42 is the frequency setting by digital potentiometer.

If F12.12=1 the frequency setting by digital potentiometer is saved in EEPROM after power off.

Table 7-1 Setting of Main Frequency Source A

Terminal Function	Description	Type
11 - 14: Preset Speed Terminal 1 - 4	It is preset speed when any terminal is enabled (F08.00 - F08.14).	1
51: Switch Main Frequency Source to Numeric Frequency Setting	If enabled, the numeric frequency is determined by F00.07, whose description refers to F00.04=0; it works the same way as that for F00.04=0.	2
52: Switch Main Frequency Source to AI1	If enabled, main frequency source A is determined by the percentage inputted through AI1; it works the same way as that for F00.04=1.	3
53: Switch Main Frequency Source to AI2	If enabled, main frequency source A is determined by the percentage inputted through AI2; it works the same way as that for F00.04=2.	4
54: Switch Main Frequency Source to AI3	If enabled, main frequency source A is determined by the percentage inputted through	5

		AI3; it works the same way as that for F00.04=3.			
	55: Switch Main Frequency Source to High-Frequency Pulse Input	If enabled, main frequency source A is determined by the percentage inputted through high-frequency pulse input; it works the same way as that for F00.04=5.			6
	56: Switch Main Frequency Source to Communication Setting	If enabled, main frequency source A is determined through communication; it works the same way as that for F00.04=6.			7
	--	If neither of terminals above is enabled, main frequency source A is determined through F00.04.			8
No.	Function	Range	Unit	Default	Type
F00.05	Auxiliary Frequency Source B	0: Numeric Frequency Setting F00.07 1: AI1 2: AI2 3: AI3 4: AI4 (Expansion Card) 5: High-Frequency Pulse Input (X7) 6: Auxiliary Frequency Communication Percentage Setting 7: Direct Auxiliary Frequency Communication Setting 8: digital Potentiometer 9: Not Used 10: Process PID 11: Simple PLC		0	○

F00.05=0: Numeric Frequency Setting F00.07

Auxiliary frequency source B is determined through numeric frequency setting F00.07.

F00.05=1: AI1**F00.05=2: AI2****F00.05=3: AI3**

F00.05=4: AI4 (Expansion Card)

Auxiliary frequency source B is determined through AI (percentage) * F00.16.

F00.05=5: High-Frequency Pulse Input (X7)

Auxiliary frequency source B is determined through HDI (percentage) * F00.16.

Please refer to the description of F00.04 for detailed explanations of AI1-AI4 and X7. F00.04 has the same meanings as AI1-AI4 and X7. 100.00% is the percentage inputted through F00.16 (Maximum Frequency).

F00.05=6 or 7: Auxiliary Frequency Setting by Communication

For master-slave communication (F10.05=1) and the inverter is slave (F10.06=0) auxiliary frequency source B is set as “700FH (Main Frequency Setting by Communication) * F00.16 (Maximum Frequency) * F10.08 (Receiving Proportionality Factor of Slave)”. The range of 700FH is -100.00% to 100.00%. See Table 12-2 for details.

For general communication (F10.05=0):

a) F00.05=6 Auxiliary Frequency Communication Percentage Setting. Auxiliary frequency source A is set as “7002H (communication setting of auxiliary channel frequency B) * F00.16 (Maximum Frequency)”.

b) F00.05=7 Auxiliary Frequency Communication Direct Setting. Auxiliary frequency source B is set as “7016H (communication setting of auxiliary channel frequency B)”.

The range of 7002H is -100.00% to 100.00%. The range of 7016H is 0.00 to F00.16 (Maximum Frequency). See Table 12-2 for details.

F00.05=8: digital Potentiometer

For speed mode auxiliary frequency source B is set as digital Potentiometer. F12.42 is the frequency setting by digital potentiometer.

If F12.12=1 the frequency setting by digital potentiometer is saved in EEPROM after power off.

F00.05=10: Process PID

Auxiliary frequency B is determined by the output of Process PID (refer to 7.10).

Generally, it is used for on-site closed loop control mode, for example closed loop control under constant pressure and closed loop control under constant tensile force.

F00.05=11: Simple PLC

Auxiliary frequency B is determined by the output of Simple PID (refer to 7.9).

1. User can not select the same terminal (AI1-4/X7) for main frequency source A and auxiliary frequency source B;
2. Process PID or simple PLC will be enabled only after being selected.

No.	Function	Range	Unit	Default	Type
F00.06	Frequency Source Options	0: Main Frequency Source A 1: Auxiliary Frequency Source B 2: Main and Auxiliary Arithmetic Results 3: Switching between Main Frequency Source A and Auxiliary Frequency Source B 4: Switching between Main Frequency Source A and Main & Auxiliary Arithmetic Results 5: Switching between Auxiliary Frequency Source B and Main & Auxiliary Arithmetic Results 6: Auxiliary Frequency Source B+ Feedforward arithmetic (Winding application)		0	○

Select final frequency setting channel and arithmetic mode.

F00.06=0: Main Frequency Source A

Final setting frequency is only determined through main frequency source A.

F00.06=1: Auxiliary Frequency Source B

Final setting frequency is only determined through auxiliary frequency source B.

F00.06=2: Main and Auxiliary Arithmetic Results

Final setting frequency is determined through main and auxiliary arithmetic results (refer to F00.08).

F00.06=3: Switching between Main Frequency Source A and Auxiliary Frequency Source B

Final setting frequency is determined through input function “26: Frequency Source Switching”. If the input function is disabled, final setting frequency is determined by main frequency source A; if the input function is enabled, final setting frequency is determined by auxiliary frequency source B.

F00.06=4: Switching between Main Frequency Source A and Main & Auxiliary Arithmetic Results

Final setting frequency is determined through input function “26: Frequency Source Switching”. If the input function is disabled, final setting frequency is determined by main frequency source A; if the input function is enabled, final setting frequency is determined by main and auxiliary arithmetic results. See F00.08 for details.

F00.06=5: Switching between Auxiliary Frequency Source B and Main & Auxiliary Arithmetic Results

Final setting frequency is determined through input function “26: Frequency Source Switching”. If the input function is disabled, final setting frequency is determined by auxiliary frequency source B; if the input function is enabled, final setting frequency is determined by main and auxiliary arithmetic results. See F00.08 for details

No.	Function	Range	Unit	Default	Type
F00.07	Numeric Frequency Setting	0.00 Hz - Maximum Frequency	Hz	50.00	●

F00.07 is used to set the numeric frequency, with its maximum value limited by the maximum frequency (F00.16)

No.	Function	Range	Unit	Default	Type
F00.08	Main and Auxiliary Arithmetic	0: Main Frequency Source A + Auxiliary Frequency Source B		0	○

		1: Main Frequency Source A - Auxiliary Frequency Source B 2: The Bigger of Main A and Auxiliary B 3: The Smaller of Main A and Auxiliary B			
--	--	---	--	--	--

As for main and auxiliary arithmetic, final results are limited by both the lower limit frequency (F00.19) and the upper limit frequency (F00.18).

F00.08=0: Main Frequency Source A + Auxiliary Frequency Source B

Main and auxiliary arithmetic result is the sum (main frequency source A + auxiliary frequency source B); the result can be either a positive figure or a negative number. For example, the arithmetic result of 20.00 Hz (forward) and 40.00 Hz (reverse) is 20.00 Hz (reverse).

F00.08=1: Main Frequency Source A - Auxiliary Frequency Source B

The arithmetic result is the difference between main frequency source A and auxiliary frequency source B, which can be positive or negative; take forward 20.00Hz and reverse 40.00Hz for example, the arithmetic result is 50.00Hz given upper limit frequency F00.18=50.00.

F00.08=2: Maximum of Main Frequency Source A and Auxiliary Frequency Source B

A main and auxiliary arithmetic result is the bigger of main frequency source A and auxiliary frequency source B; the result can be either a positive figure or a negative number. For example, the arithmetic result of 20.00 Hz (forward) and -40.00 Hz (reverse) is 20.00 Hz (forward).

F00.08=3: Minimum of Main Frequency Source A and Auxiliary Frequency Source B

Main and auxiliary arithmetic result is the smaller of main frequency source A and auxiliary frequency source B; the result can be either a positive figure or a negative number. For example, the arithmetic result of 20.00 Hz (forward) and -40.00 Hz (reverse) is -40.00Hz (reverse).

No.	Function	Range	Unit	Default	Type
F00.09	Reference Option for Auxiliary Frequency Source B at Main and Auxiliary Arithmetic	0: Relative to Maximum Frequency 1: Relative to Main Frequency Source A		0	○

At main and auxiliary arithmetic, the range of auxiliary frequency source B follows the object option, and the default is the maximum frequency. If the selection corresponds to main frequency source A (F00.09=1), auxiliary frequency source B changes along with main frequency source A (the default is to follow the maximum frequency).

No.	Function	Range	Unit	Default	Type
F00.10	Main Frequency Source Gain	0.0 - 300.0	%	100.0	●
F00.11	Auxiliary Frequency Source Gain	0.0 - 300.0	%	100.0	●
F00.12	Synthetic Gain of Main and Auxiliary Frequency	0.0 - 300.0	%	100.0	●
F00.13	Analog Input Adjustment of Synthetic Frequency	0: Synthetic Frequency of Main and Auxiliary Channels 1: AI1* Synthetic Frequency of Main and Auxiliary Channels 2: AI2* Synthetic Frequency of Main and Auxiliary Channels 3: AI3 * Synthetic Frequency of Main and Auxiliary Channels 4: AI4 * Synthetic Frequency of Main and Auxiliary Channels 5: High-Frequency Pulse (PULSE) * Synthetic		0	○

		Frequency of Main and Auxiliary Channels			
--	--	--	--	--	--

The parameters above are mainly used to adjust the gain of various setting sources (refer to Figure 7-3). Both main frequency source A and auxiliary frequency source B have the setting gain; there is the synthetic gain by combination with the selected function code F00.06. The final setting is limited by analog adjustment input, upper limit frequency and lower limit frequency.

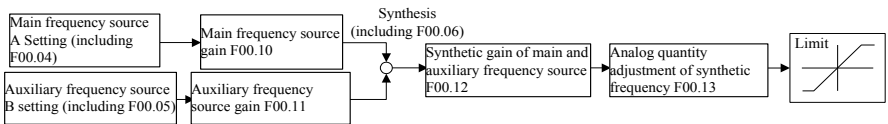

Figure 7-3 Frequency Source Setting Control (Gain Description)

The action mode of function codes about gain (F00.10 - F00.12) is “multiply”, i.e., “Setting=Former setting * gain”. The following will describe the analog input adjustment of synthetic frequency (F00.13).

F00.13=0: Synthetic Frequency of Main and Auxiliary Channels

Synthetic frequency is directly set by the synthetic frequency of main and auxiliary channels.

F00.13=1: AI1 * Synthetic Frequency of Main and Auxiliary Channels

F00.13=2: AI2 * Synthetic Frequency of Main and Auxiliary Channels

F00.13=3: AI3 * Synthetic Frequency of Main and Auxiliary Channels

F00.13=4: AI4 (Expansion Card) * Synthetic Frequency of Main and Auxiliary Channels

The synthetic frequency is determined through “AI (percentage) * Synthetic Frequency of Main and Auxiliary Channels”.

F00.13=5: High-Frequency Pulse (X7) * Synthetic Frequency of Main and Auxiliary Channels

The synthetic frequency is determined through “HDI (percentage) * Synthetic Frequency of Main and Auxiliary Channels”.

Please refer to the description of F00.04 for detailed explanations of AI1-AI4 and

X7. F00.04 has the same meanings as A11-A14 and X7. 100.00% is the percentage inputted through Synthetic Frequency of Main and Auxiliary Channels.

No.	Function	Range	Unit	Default	Type
F00.14	Acceleration Time 1	0.00 - 650.00 (F15.13=0) 0.0 - 6500.0 (F15.13=1) 0 - 65000 (F15.13=2)	s	15.00	●
F00.15	Deceleration Time 1	0.00 - 650.00 (F15.13=0) 0.0 - 6500.0 (F15.13=1) 0 - 65000 (F15.13=2)	s	15.00	●

Acceleration time refers to the time required for output frequency going from 0.00Hz to the acceleration/deceleration reference frequency F_{base} , or the time required for output frequency coming down from the acceleration/deceleration reference frequency F_{base} to 0.00Hz; this has nothing to do with forward/reverse. See Figure 7-4.

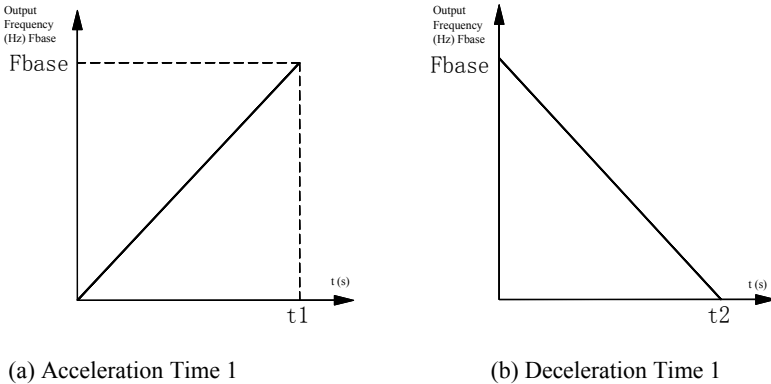

Figure 7-4 Acceleration/Deceleration Time

Note: There are three acceleration/deceleration time units, 0.01 s, 0.1 s and 1 s, which are determined through F15.13.

No.	Function	Range	Unit	Default	Type
F00.16	Maximum Frequency	1.00 - 600.00	Hz	50.00	○

F00.16 is the maximum frequency allowed by inverter and denoted by F_{max} (range: 1.00 - 600.00 Hz).

No.	Function	Range	Unit	Default	Type
F00.17	Upper Limit Frequency Control Options	0: Set through F00.18 1: AI1 2: AI2 3: AI3 4: AI4 (Expansion Card) 5: High-Frequency Pulse Input (X7) 6: Communication Percentage Setting 7: Direct Upper Limit Frequency Communication Setting		0	
F00.18	Upper Limit Frequency	Lower Limit Frequency F00.19 - Maximum Frequency F00.16	Hz	50.00	●
F00.19	Lower Limit Frequency	0.00 - Upper Limit Frequency F00.18	Hz	0.00	●

F00.17=0: Set through F00.18

Upper limit frequency is set through F00.18.

F00.17=1: AI1**F00.17=2: AI2****F00.17=3: AI3****F00.17=4: AI4 (Expansion Card)**

Upper limit frequency is set through "AI (percentage) * F00.18".

F00.17=5: High-Frequency Pulse Input (X7)

Upper limit frequency is set through "HDI (percentage) * F00.18".

Please refer to the description of F00.04 for detailed explanations of AI1-AI4 and X7. F00.04 has the same meanings as AI1-AI4 and X7. 100.00% is the percentage inputted through F00.18 (Upper Limit Frequency).

F00.17=6 or 7: Communication Setting

For master-slave communication (F10.05=1) and the inverter is slave (F10.06=0) upper limit frequency is set as "700FH (Main Frequency Setting by Communication) * F00.18 (upper limit frequency)* F10.08 (Receiving Proportionality Factor of Slave)".

The range of 700FH is -100.00% to 100.00%. See Table 12-2 for details.

For general communication (F10.05=0)

★ For F00.17=6, upper limit frequency is “700AH (communication setting of upper limit frequency) * F00.18 (upper limit frequency)” .

★ For F00.17=7, upper limit frequency is “7017H (communication setting of upper limit frequency)”

The range of 700AH is 0.00% to 200%. The range of 7017H is 0.00 to F00.16 (maximum frequency). See Table 12-2 for details.

F00.18 is the maximum operating frequency after inverter starts and denoted by Fup (range: Fdown - Fmax).

F00.19 is the minimum operating frequency after inverter starts and denoted by Fdown (range: 0.00 Hz - Fup).



1. Upper limit frequency and lower limit frequency shall be set carefully according to the nameplate parameters and working conditions of the controlled motor. Otherwise, motor, after having worked for a long time at a low frequency, would lose its service life due to overheating.
2. The relationship among maximum frequency, upper limit frequency and lower limit frequency: $0.00 \text{ Hz} \leq F_{\text{down}} \leq F_{\text{up}} \leq F_{\text{max}} \leq 600.00 \text{ Hz}$.
3. When the set frequency is lower than F00.19 (lower limit frequency), the running mode of inverter is determined through F15.33.

No.	Function	Range	Unit	Default	Type
F00.20	Running Direction	0: Same 1: Opposite		0	●

By changing the function code, user may reverse motor rotation direction without changing motor wiring. Its function is the same as the switching of any two terminals of motor (U, V and W) in turning motor rotation direction.



1. After parameter initialization, the running direction of motor will be restored to the original status.
 2. After system debugging, this function should be used with caution for occasion where motor is not allowed to be reversed.
- his function is disabled, if inverter is not allowed to be reversed (for example .21=1).

No.	Function	Range	Unit	Default	Type
F00.21	Reverse Control	0: Permit forward/reverse 1: Prohibit reverse		0	○
F00.22	F/R Deadband Time	0.00 - 650.00	s	0.00	●

F00.21=0: Permit forward/reverse

The rotation direction of motor can be controlled by the set F/R terminal or F00.20.

F00.21=1: Prohibit reverse Motor can run at one direction only and neither terminal F/R nor F00.20 is enabled.

Select the status when motor switches between forward and reverse.

If F00.22=0.00, the switch between forward and reverse completes smoothly.

If F00.22≠0, then inverter runs for the time set through F00.22 at 0.00 Hz and runs at the reverse direction until the set frequency is reached, after the rotation speed decreases to 0.00 Hz at the time of switching between forward and reverse. See Figure 7-5 for details.

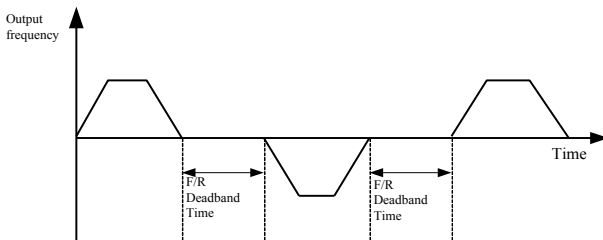

Figure 7-5 Forward/Reverse Deadband Time



Inverter judges the direction according to the status of terminal F/R and the value set through F00.20. If the set forward direction is inconsistent with the wished motor direction, switch any two of inverter's output terminals U, V and W, or change F00.20 to an inverse value.

No.	Function	Range	Unit	Default	Type
F00.23	Carrier Frequency	1.0 - 16.0 (inverter rated power 4 kW) 1.0 - 10.0 (inverter rated power 5.50 – 7.50 kW)	kHz	4.0 (7.5kW and	●

		1.0 - 8.0 (inverter rated power 11.00 - 45.00 kW) 1.0 - 4.0 (inverter rated power 55.00 - 90.00 kW) 1.0 - 3.0 (inverter rated power 110.00 - 560.00 kW)		below/2.0)	
--	--	---	--	------------	--

Increasing carrier frequency can reduce motor noise, but it will increase inverter heat as well. When the carrier frequency is higher than the default value, increasing the carrier frequency by 1 kHz requires the load to decrease to some extent. Please set F00.24=1, and at this time, inverter will automatically adjust the actual carrier frequency based upon the actual condition.

It's recommend to set the relationship between inverter's rated power and carrier frequency as shown in Table 7-2.

Table 7-2 Setting Relationship between Inverter Rated Power and Carrier Frequency

Inverter Frequency Pe	Pe≤4kW	5.5kW - 7.5kW	11kW - 45kW	55kW - 90kW	110kW - 560kW
Rated Carrier	4.0 kHz		2.0kHz		
Maximum Carrier	16.0 kHz	10.0kHz	8.0kHz	4.0kHz	3.0kHz

No.	Function	Range	Unit	Default	Type
F00.24	Automatic Adjustment of Carrier Frequency	0: Disabled 1: Enabled 1 2: Enabled 2		1	○

F00.24=0: Disabled

The carrier frequency is set through F00.23, limited by maximum carrier and will not change during running.

F00.24=1: Enabled 1

The carrier frequency set through F00.23 is affected by inverter temperature and load level. If inverter has an excessively high temperature or load, the carrier wave will be limited. When the set carrier frequency F00.23 is greater than the limit value, the limit value shall be used as the carrier frequency of inverter.

F00.24=2: Enabled 2

Conduct carrier frequency self-tuning based on the setting of F00.23.

No.	Function	Range	Unit	Default	Type
F00.25	Carrier Frequency Noise Suppression	0: Disabled 1: Enabled		0	○
F00.26	Noise Suppression Tone	20 - 200	Hz	40	●
F00.27	Noise Suppression Intensity	10 - 150	Hz	100	●

When noise suppression function is enabled (F00.25=1), a sine wave may be superposed on the basis of the set carrier wave (the frequency is set through F00.26 and the intensity is set through F00.27), which may suppress present motor noise to some extent.

No.	Function	Range	Unit	Default	Type
F00.28	Motor Parameter Group	0: Motor 1 Parameter 1: Motor 2 Parameter		0	○

EM500 inverter supports the time interval based control of two motors, of which motor parameter and control parameter can be set separately. Motor 1 corresponds to parameters of F00, F01 and F06, and motor 2 corresponds to parameters of F14.

In combination with the input function “30: Switch between Motor 1 and Motor 2”, F00.28 can be used to select present motor (see Table 7-3 for details).

Table 7-3 Motor Parameter Group Selection

F00.28: Motor Parameter Group	30: Switch between Motor 1 and Motor 2	Enabled Motor	Parameter Groups
0: Motor 1 Parameter	Disabled	Motor 1	F00/F01/F06
	Enabled	Motor 2	F14
1: Motor 2 Parameter	Disabled	Motor 2	
	Enabled	Motor 1	F00/F01/F06

No.	Function	Range	Unit	Default	Type
F00.29	User Password	0 - 65535		0	○

F00.29 is used to set a new password to enable the password protection function and avoid misoperation of the function codes of inverter. If the new password is 0, then the

password protection function is disabled. After setting the user password (none 0), in addition to the function code, all the parameters can only be viewed, cannot be modified.

No.	Function	Range	Unit	Default	Type
F00.30	Inverter Type	0: G 1: P		0	○

F00.30=0 Set inverter as Type G, which applies to mechanical and constant torque load;

F00.30=1 Set inverter as Type P, which applies to fan, water pump and other square or cubic load.

★ When inverter is set as Type P, please refer to motor nameplate for applicable motor power. **Make sure that it cannot be applied to constant torque load at this type.**

7.2 F01 Group: Motor 1 Parameter

No.	Function	Range	Unit	Default	Type
F01.00	Motor Type	0: Common Induction Motor 1: Inverter Induction Motor 2: Permanent Magnet Synchronous Motor		0	○

EM500 supports the induction motor and the synchronous motor. Please set this parameter according to actual applications.

No.	Function	Range	Unit	Default	Type
F01.01	Motor Rated Power	0.10 - 650.00	kW	Jp To Specific Model	○
F01.02	Motor Rated Voltage	50 - 2000	V	Jp To Specific Model	○
F01.03	Motor Rated Current	0.01 - 600.00 (Motor Rated Power ≤ 75kW) 0.1 - 6000.0 (Motor Rated Power >75kW)	A	Jp To Specific Model	○
F01.04	Motor Rated Frequency	0.01 - 600.00	Hz	Jp To Specific Model	○
F01.05	Motor Rated Speed	1 - 60000	rpm	Jp To Specific	○

				Model	
F01.06	Motor Winding Connection	0: Y 1: Δ		Up To Specific Model	○
F01.07	Motor Rated Power Factor	0.600 - 1.000		Up To Specific Model	○
F01.08	Motor Efficiency	30.0 - 100.0	%	Up To Specific Model	○

Function codes mentioned above are nameplate parameters of induction motor. For the first time when inverter is wired to motor, please set the parameters above as per motor nameplate before inverter running, regardless of the control mode, VF control mode or vector control mode.

When motor rated power (F01.01) is set, inverter will modify the values of the parameters of F01.03 - F01.08 automatically. Please pay attention while using inverter.

No.	Function	Range	Unit	Default	Type
F01.09	Stator Resistor of Induction Motor	1 - 60000 (Motor Rated Power \leq 75kW) 0.1 - 6000.0 (Motor Rated Power $>$ 75kW)	m Ω	Up To Specific Model	○
F01.10	Stator Resistor of Induction Motor	1 - 60000 (Motor Rated Power \leq 75kW) 0.1 - 6000.0 (Motor Rated Power $>$ 75kW)	m Ω	Up To Specific Model	○
F01.11	Leakage Inductance of Induction Motor	0.01 - 600.00 (Motor Rated Power \leq 75kW) 0.001 - 60.000 (Motor Rated Power $>$ 75kW)	mH	Up To Specific Model	○
F01.12	Mutual Inductance of Induction Motor	0.1 - 6000.0 (Motor Rated Power \leq 75kW) 0.01 - 600.00 (Motor Rated Power $>$ 75kW)	mH	Up To Specific Model	○
F01.13	Idling Excitation Current of Induction Motor	0.01 - 600.00 (Motor Rated Power \leq 75kW) 0.1 - 6000.0 (Motor Rated Power $>$ 75kW)	A	Up To Specific Model	○

F01.09 - F01.13 are parameters of induction motor. However, user can not get these parameters generally. Please autotune motor parameters by using F01.34.

After motor parameters of F01.01 - F01.08 are modified, inverter will modify the

parameters of F01.09 - F01.13. Please pay attention.

User must set the parameters of F01.00 - F01.08 as per actual conditions before motor parameter autotuning.

Meanings of motor parameters are illustrated in Figure 7–6:

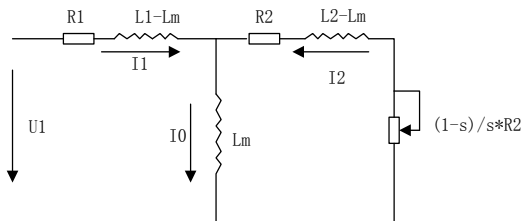

Figure 7–6 Induction Motor Stable Equivalent Model

In the figure, R1, L1, R2, L2, Lm and I0 refer to stator resistor, stator inductance, rotor resistor, rotor inductance, stator & rotor mutual inductance, and idling excitation current respectively.

Function Code	Name of Function Code	Parameter Description	Unit	Default	Property
F01.14	Induction Motor Field Weakening Factor 1	10.00 - 100.00	%	87.00	○
F01.15	Induction Motor Field Weakening Factor 2	10.00 - 100.00	%	80.00	○
F01.16	Induction Motor Field Weakening Factor 3	10.00 - 100.00	%	75.00	○
F01.17	Induction Motor Field Weakening Factor 4	10.00 - 100.00	%	72.00	○
F01.18	Induction Motor Field Weakening Factor 5	10.00 - 100.00	%	70.00	○

The field weakening factor of induction motor will be automatically set in motor parameter autotuning. User does not need to set these factors.

No.	Function	Range	Unit	Default	Type
F01.19	Stator Resistor of Synchronous Motor	1 - 60000 (Motor Rated Power \leq 75kW) 0.1 - 6000.0 (Motor Rated Power $>$ 75kW)	m Ω	Up To Specific Model	<input type="radio"/>
F01.20	d-Shaft Inductance of Induction Motor	0.01 - 600.00 (Motor Rated Power \leq 75kW) 0.001 - 60.000 (Motor Rated Power $>$ 75kW)	mH	Up To Specific Model	<input type="radio"/>
F01.21	q-Shaft Inductance of Synchronous Motor	0.01 - 600.00 (Motor Rated Power \leq 75kW) 0.001 - 60.000 (Motor Rated Power $>$ 75kW)	mH	Up To Specific Model	<input type="radio"/>
F01.22	Counter Electromotive Force of Synchronous Motor	10.0 - 2000.0 (Counter Electromotive Force of Rated Rotation Speed)	V	Up To Specific Model	<input type="radio"/>
F01.23	Initial Electric Angle of Synchronous Motor	0.0 - 359.9 (Synchronous motor enabled)			<input type="radio"/>

F01.09 - F01.13 are parameters of synchronous motor. However, user can not get these parameters generally. Please autotuning motor parameters by F01.34.

User must set the parameters of F01.00 - F01.08 as per actual conditions before motor parameter autotuning and make sure to select a proper type of motor (F01.00=2).

No.	Function	Range	Unit	Default	Type
F01.34	Motor Parameter Autotuning	0: No Autotuning 1: Stationary Autotuning of Induction Motor 2: Rotational Autotuning of Induction Motor 11: Stationary Autotuning of Synchronous Motor 12: Rotational Autotuning of Synchronous Motor		0	<input type="radio"/>

F01.34=0: No Autotuning

F01.34=1: The induction motor remains stationary in parameter autotuning.

User must set motor type (F01.00) and motor nameplate parameters (F01.01 - F01.08) correctly before the stationary autotuning of induction motor. By stationary autotuning, user may get relevant parameters of induction motor, including F01.09 - F01.13.

This method mainly applies to the working condition where motor can not rotate, but its effect is not as good as that of rotational autotuning.

F01.34=2: The induction motor remains rotational in the parameter autotuning.

User must set motor type (F01.00) and motor nameplate parameters (F01.01 - F01.08) correctly before rotational autotuning of induction motor. By rotational autotuning, user may get relevant parameters of induction motor, including F01.09 - F01.13.

This method mainly applies to the working condition where motor can rotate, but better not to have a load or better to have a light load in parameter autotuning; otherwise the autotuning effect will go down.

F01.34=11: Synchronous motor remains stationary in parameter autotuning.

User must set motor type (F01.00) and motor nameplate parameters (F01.01 - F01.05) correctly before the stationary autotuning of the synchronous motor. By stationary autotuning, user may get relevant parameters of induction motor (F01.19 - F01.21), current loop parameters (F06.12 - F06.15), etc.



This method mainly applies to the condition where motor can not rotate and user needs to input the “Counter Electromotive Force” (F01.22) manually.

F01.34=12: Synchronous motor remains rotational in parameter autotuning.

User must set motor type (F01.00) and motor nameplate parameters (F01.01 - F01.05) correctly before rotational autotuning of the synchronous motor. By rotational autotuning, user may get relevant parameters of synchronous motor (F01.19 - F01.21), current loop parameters (F06.12 - F06.15), Counter Electromotive Force of synchronous motor (F01.22), etc.

This method mainly applies to the working condition where motor can rotate, but better not to have a load or better to have a light load in parameter autotuning; otherwise the autotuning effect will go down.



1. Motor autotuning will be only enabled under keypad start/stop control mode (F00.02=0): Only after setting F01.34 to corresponding value and press , and press run  for confirmation can motor autotuning be started. After autotuning finishes, inverter will set F01.34 to 0 automatically.
2. In case of overcurrent or overvoltage fault in autotuning, please lengthen the acceleration/deceleration time first and try it again.
3. Motor parameters of the first group above are only taken as an example. For motor parameters of the second group, please refer to those parameters of the first group.

7.3 F02 Group: Input Terminal Parameter

EM500 inverter has 7 multi-functional input terminals (X1 - X7) and 3 analog input terminals (AI1 - AI3, only enabled when corresponding function is the numeric input; refer to F02.31). In addition, user may select an IO expansion card (EC-IO-A1, refer to Appendix I), which offers 4 multi-function numeric input terminals (X8 - X11) and 1 analog voltage signal input terminal (AI4, with the same setting as AI1 - AI3).

No.	Function	Range	Unit	Default	Type
F02.00	X1 Numeric Input Function	See Table 7-4 Functions of Numeric Multi-Function Input Terminals		1	○
F02.01	X2 Numeric Input Function			2	○
F02.02	X3 Numeric Input Function			11	○
F02.03	X4 Numeric Input Function			12	○
F02.04	X5 Numeric Input Function			13	○
F02.05	X6 Numeric Input Function			14	○
F02.06	X7 Numeric Input Function			10	○
F02.07	AI1 Numeric Input Function			0	○
F02.08	AI2 Numeric Input Function			0	○
F02.09	AI3 Numeric Input Function			0	○
F02.10	AI4 Numeric Input Function (Expansion Card)			0	○
F02.11	X8 Numeric Input Function		0	○	

	(Expansion Card)			
F02.12	X9 Numeric Input Function (Expansion Card)		0	○
F02.13	X10 Numeric Input Function (Expansion Card)		0	○
F02.14	X11 Numeric Input Function (Expansion Card)		0	○

X1 - X11 and AI1 - AI4 are 15 numeric multi-function input terminals. By setting the function codes F02.00 - F02.14, user can define the functions of those input terminals respectively.

For example, if F02.00=1, X1 is “RUN”. If the terminal control (F00.02=1) is selected as the command source, then inverter starts the function RUN when X1 terminal input is valid. See Table 7-4 for specific function options.

If more than one terminal is set to the same function (except the function 34), the function is determined by the state of two terminals or logic. For example, If F02.00=1 and F02.05=1 either X1 or X6 is effective “RUN” of inverter is effective.

Table 7-4 Numeric Multi-Function Input Terminals

Value	Function	Description
0	No Function	Set “0: No Function” for an unused or fault terminal to prevent false output.
1	Run Terminal “RUN”	If the terminal control (F00.02=1) is selected as the command source, inverter executes the function F/R according to the setting value of the terminal control mode F00.03 under the condition that the function terminal is enabled. (See F00.03 Function Code)
2	Direction R/F	If the terminal control (F00.02=1) is selected as the command source, inverter executes the function F/R according to the setting value of the terminal control mode F00.03 under the condition that the function terminal is enabled. (See F00.03 Function Code)
3	3-Wire Sequence Stop Control	If the terminal control (F00.02=1) is selected as the command source and the terminal control mode is 3-wire sequence control (F00.03=2/3), inverter executes the stop command under the condition that the function terminal is enabled. (See F00.03 Function Code)

4	Forward JOG (FJOG)	If the command source is selected as terminal control (F00.02=1), inverter runs forward under the condition that FJOG function terminal is enabled. Inverter runs reversely, if RJOG function terminal is enabled. If both FJOG and RJOG are enabled at the same time, inverter will ram to stop. See Figure Table 7-20.										
5	Reverse JOG (RJOG)	★ If reverse is prohibited, FJOG is disabled.										
6	Terminal UP	If the function terminal UP is enabled, the frequency offset will increase at the speed defined through F12.11; if the function terminal DOWN is enabled, the frequency offset will decrease at the speed defined through F12.11.										
7	Terminal DOWN	If UP/DOWN offset clear terminal is enabled, the frequency offset will be cleared;										
8	UP/DOWN Offset Clear	Setting source of the final frequency source A = Setting frequency of the frequency source A + UP/DOWN offset. ★ The UP/DOWN function is only enabled when main frequency source A is involved in setting; The offset frequency can be viewed through F18.15. The terminal UP/DOWN has the same function as UP/DOWN on the keypad.										
9	Coast-to-Stop	Inverter will be blocked for output and coast to stop, if this function terminal is enabled during the running. At this time, inverter is not controlled by inverter.										
10	Fault Reset	This terminal can be used for reset if inverter fails and the failure is remedied. It has the same functions as the reset button on the keypad.										
11	Preset Speed Terminal 1	If inverter is in the speed control mode and main frequency source A is involved in setting, user can define 4 function input terminals as preset speed terminals. The combined code of the 4 terminals and the setting of relevant function codes determine present frequency setting of inverter. As stated in the following table: (0/1: Present function terminal disabled/enabled). See table 7-10.										
12	Preset Speed Terminal 2	★ If no option has been selected for the input terminal of a function, the default value is 0 (disabled).										
		<table border="1"> <thead> <tr> <th>14</th> <th>13</th> <th>12</th> <th>11</th> <th>Inverter Setting Frequency</th> </tr> </thead> <tbody> <tr> <td>0</td> <td>0</td> <td>0</td> <td>0</td> <td>Determined by main frequency source A (F00.04)</td> </tr> </tbody> </table>	14	13	12	11	Inverter Setting Frequency	0	0	0	0	Determined by main frequency source A (F00.04)
14	13	12	11	Inverter Setting Frequency								
0	0	0	0	Determined by main frequency source A (F00.04)								

13	Preset Speed Terminal 3	0	0	0	1	Preset Speed 1 (F08.00)
		0	0	1	0	Preset Speed 2 (F08.01)
		0	0	1	1	Preset Speed 3 (F08.02)
		0	1	0	0	Preset Speed 4 (F08.03)
		0	1	0	1	Preset Speed 5 (F08.04)
		0	1	1	0	Preset Speed 6 (F08.05)
14	Preset Speed Terminal 4	0	1	1	1	Preset Speed 7 (F08.06)
		1	0	0	0	Preset Speed 8 (F08.07)
		1	0	0	1	Preset Speed 9 (F08.08)
		1	0	1	0	Preset Speed 10 (F08.09)
		1	0	1	1	Preset Speed 11 (F08.10)
		1	1	0	0	Preset Speed 12 (F08.11)
		1	1	0	1	Preset Speed 13 (F08.12)
		1	1	1	0	Preset Speed 14 (F08.13)
1	1	1	1	Preset Speed 15 (F08.14)		
15	Preset PID Terminal 1	With these two terminals, inverter can realize 4 preset PID settings. See the table below (0/1: Present function terminal is disabled / enabled) or table 7-16.				
16	Preset PID Terminal 2	16	15	Preset PID Setting		
		0	0	Determined by PID setting source (F09.00)		
		0	1	Preset PID Setting 1 (F09.32)		
		1	0	Preset PID Setting 2 (F09.33)		
1	1	Preset PID Setting 3 (F09.34)				
17	Preset Torque Terminal 1	With these two terminals, inverter can realize 4 torque settings. See the table below (0/1: Present function terminal is disabled / enabled) or table 7-19.				
18	Preset Torque Terminal 2	18	17	Preset Torque Setting		
		0	0	Determined by the torque setting source (F13.01)		
		0	1	Preset Torque 1 (F13.03)		
		1	0	Preset Torque 2 (F13.04)		
1	1	Preset Torque 3 (F13.05)				
19	Acceleration/Deceleration Time Terminal 1	EM500 inverter has four groups of acceleration/deceleration terminals, each group having two input terminals for acceleration and deceleration. The setting of the combined code of the 4 terminals, and relevant functions determines present acceleration/deceleration time. As stated in the following table: (0/1: Present function terminal disabled/enabled). See function				

		codes F15.03 - F15.13.		
20	Acceleration/Deceleration Time Terminal 2	20	19	Acceleration/Deceleration Time
		0	0	Group 1 (Acceleration Time: F00.14, Deceleration Time: F00.15)
		0	1	Group 2 (Acceleration Time: F15.03, Deceleration Time: F15.04)
		1	0	Group 3 (Acceleration Time: F15.05, Deceleration Time: F15.06)
		1	1	Group 4 (Acceleration Time: F15.07, Deceleration Time: F15.08)
21	Acceleration/Deceleration Prohibited	If the acceleration/deceleration time terminal is disabled, the command for acceleration/deceleration is prohibited and inverter's output frequency remains the same. If inverter is under the overcurrent protection status, run inverter as per current limit mode.		
22	Operation Pause	Inverter ramps to stop, but all running parameters are memorized, for example PLC parameter and PID parameter. If the terminal is disabled, inverter is reset to the pre-stop running status.		
23	External Fault Input	The fault signal of external devices can be inputted through this terminal, so that inverter monitors and protects peripherals at fault. Upon receiving external fault signal, inverter displays "E14", and coast to stop.		
24	Switch Run Command to Keypad	Together with F00.02, these two terminals determine the present command channel. The priority rule is "24: Switch Run Command to Keypad" > "25: Switch Run Command to Communication" > "F00.02: Command Source" (see F00.02).		
25	Switch Run Command to Communication			
26	Frequency Source Switching	Mainly used with F00.06, and applied to the switching of the frequency source. This terminal works only when F00.06=3 - 5. See F00.06 for details		
27	Clear Timed Running time	This terminal is defined through F16.05 and used to clear the time that inverter has run (reset the remaining time of the timed run). See F16.05 for details.		
28	Switch between	The control mode of inverter is selected by these two terminals		

	Speed Control and Torque Control	and F13.00: if no.28 terminal is enabled, the control mode of inverter will switch between speed control and torque control; if
29	Torque Control Disabled	no.29 terminal is enabled, only the speed control works. See F13.00 for details.
30	Switch between Motor 1 and Motor 2	This terminal and F00.28 are used together to determine present set motor: if no.30 terminal is enabled, the switch can be completed based upon F00.28. See F00.28 for details.
31	Simple PLC Status Reset (Start to Run with Preset Speed 1, Clear Running time)	When this terminal is enabled, simple PLC module will start to run again from the first preset speed. To further understand this function, user may view the simple PLC description of F08.
32	Simple PLC Time Pause (Keep Running at Preset Speed)	When this terminal is enabled, the simple PLC module will keep running at present speed; after it is disabled, the simple PLC module will continue running after present speed stage is completed.
33	Not used	
34	Count Input ($\leq 250\text{Hz}$)	The pulse input terminal with the count function limits the input pulse frequency to $\leq 250\text{Hz}$. Only one terminal can be set with this function. See F16.03 - F16.04 for details
35	High-Speed Count Input ($\leq 100\text{kHz}$, Only Enabled for X7)	The pulse input terminal with the count function limits the input pulse frequency to $\leq 100\text{kHz}$. Only one terminal can be set with this function. See F16.03 - F16.04 for details.
36	Counter Clear	Clear the counter that has the counter function
37	Length Count Input ($\leq 250\text{Hz}$)	The pulse input terminal with the length count function limits the input pulse frequency to $\leq 250\text{ Hz}$. Only one terminal can be set with this function. See F16.01 - F16.02 for details.
38	High-Speed Length Count Input ($\leq 100\text{kHz}$, Only Enabled for X7)	The pulse input terminal with the count function limits the input pulse frequency to $\leq 100\text{kHz}$. This terminal is only enabled for X7 (i.e., F02.06=38). See F16.01 - F16.02 for details
39	Length Clear	A length clear terminal with the length count function
40	Pulse Input ($\leq 100\text{kHz}$, Only Enabled for X7)	This is a pulse signal input terminal with the input pulse frequency $\leq 100\text{kHz}$. It is only enabled for X7. ★ This function can not be used for special functions (for example, count). This terminal is only used as the setting equivalent to AI percentage. If F00.04=5, then set F02.06=40 and set the frequency pulse through the terminal X7.
41	Process PIC Pause	When this terminal is enabled, then PID stops the adjustment. At this time, the process maintains the output. For more

		information, please refer to the function code F09.18.
42	Process PID Integral	When this terminal is enabled, the integral adjustment function of PID pauses, but proportional adjustment and differential adjustment of PID are still enabled, so this function is called “integral separation”. See F09.20 for details
43	PID Parameter Switching	PID parameter switch is completed by the numeric input terminal (F09.11=2). If the terminal is Enabled, then PID parameters may be switched. See F09.05 - F09.13 for details
44	PID Positive/Negative Action Switch	When the terminal is enabled, inverter will switch between PID action mode and positive/negative action
45	Stop and DC Brake	Trigger the stop command, and start braking when the start frequency of DC brake at stop (F04.20) is reached. The brake time shall be either terminal closing time or the time of DC brake at stop (F04.22), see whichever is longer.
46	DC Brake at Stop	Not to trigger stop command. In case of stop command, start braking when the start frequency of DC brake at stop (F04.20) is reached. The brake time shall be either terminal closing time or the time of DC brake at stop (F04.22), see whichever is longer.
47	Immediate DC Brake	After this terminal is enabled, inverter stops and starts DC brake at present frequency immediately. The brake current is determined by DC Brake Current at Stop (F04.21).
48	Fastest Coast-To-Stop	When this terminal is enabled, inverter stops at the permitted fastest acceleration/deceleration time.
49	Not Used	
50	External Stop	Inverter stops as set stop mode (F04.19) and acceleration/deceleration time 4 (F15.07/F15.08) when this terminal is enabled.
51	Switch Main Frequency Source to Numeric Frequency Setting	If this terminal is enabled, the main frequency source will be switched to corresponding setting under the conditions that main frequency source A is involved in setting and inverter is not in preset speed mode; functions of 51 to 56 may work independently, but have a priority sequence. See Table 7-1 of F00.04 for details.
52	Switch Main Frequency Source to AI1	
53	Switch Main Frequency Source to AI2	
54	Switch Main	

	Frequency Source to AI3	
55	Switch Main Frequency Source to High-Frequency Pulse Input	
56	Switch Main Frequency Source to Communication Setting	
57	Inverter Enabled	<p>If inverter meets other running conditions and this terminal is enabled, then inverter can run; otherwise, inverter can not run if inverter meets other running conditions but this terminal is disabled.</p> <p>★ Enable inverter: if no terminal option is selected, the default is enabled; if there is only one terminal option, the selected terminal status works; if there are more than one terminal, this terminal will be disabled as long as one of the selected terminals is disabled.</p>
57~78	Not Used	
79	Remote Start	<p>Air compressor Special Function, set as air compressor applications (F16.00 = 2) and the remote control (F28.01 = 1). When the inverter is not running, remote control is closed and the system restarts, disconnected and the system shutdown. If the inverter has started in the other way, the function will be invalid.</p>
80	Power Frequency Conversion	<p>When F16.12 = 3 (Phase sequence phase card) and selection for the manual switch (F15.45 = 1), if the phase sequence detected meets the switching condition, then close this function terminal and it can be switched, otherwise it can not be switched.</p>
81~88	Not Used	
89	Feedforward Reset	<p>Winding application-specific function, close the terminal, feedforward value will be reset to the starting feedforward</p>

90 ~ 103	Not Used	
104	Inlet pool Upper Limit Water Level Signal	Water supply application-specific functions, set this function must be set Inlet pool lower limit water level signal (105) function, Inlet pool function to take effect
105	Inlet pool Lower Limit Water Level Signal	Water supply application-specific functions, set this function must be set Inlet pool upper limit water level signal (104) function, Inlet pool function to take effect
106	Inlet pool Lack Of Water Level Signal	Water supply application-specific functions, Inlet pool related functions
107	Sewage Pool upper Limit Water Level Signal	Water supply application-specific functions,, set this function must be set Sewage Pool lower Limit Water Level Signal (108) function, Sewage Pool function to take effect
108	Sewage Pool lower Limit Water Level Signal	Water supply application-specific functions,, set this function must be set Sewage Pool upper Limit Water Level Signal (107) function, Sewage Pool function to take effect
109	Not Used	
110	External Overpressure Signal	Water supply application-specific function, for providing an external overpressure signal.
111	Not Used	
112	Switch The Pump	Water supply application-specific function, For the Primary pump and standby pump switch is used.
113 ~ 120	Not Used	

121	External Signals Of Material supply disruptions	Winding application-specific function, used to provide Material supply disruptions external input function, when the Material supply disruptions detection for the external signal and the terminal is closed (Satisfy the constraints) reported E43 error.
122	Winding traverse Detection Signal	Winding application-specific function, Used to provide cable detection function, when the Winding traverse detection signal valid time or invalid time time-out that reported E44 error.
123	Braking Reset Terminals	Winding application-specific function, When the brake output is active, the brake output can be reset by closing the terminal.

No.	Function	Range									Unit	Default	Type				
		D7	D6	D5	D4	D3	D2	D1	D0								
F02.15	Positive/Negative Logic 1 of Numeric Input Terminal	*	X7	X6	X5	X4	X3	X2	X1		*00 00000	○					
		0: Positive Logic, Enabled at On/Disabled at Off															
		1: Negative Logic, Disabled at On/Enabled at Off															
F02.16	Positive/Negative Logic 2 of Numeric Input Terminal	D7	D6	D5	D4	D3	D2	D1	D0		000 00000	○					
		X11	X10	X9	X8	A14	A13	A12	A11								
		0: Positive Logic, Enabled at On/Disabled at Off															
									1: Negative Logic, Disabled at On/Enabled at Off								

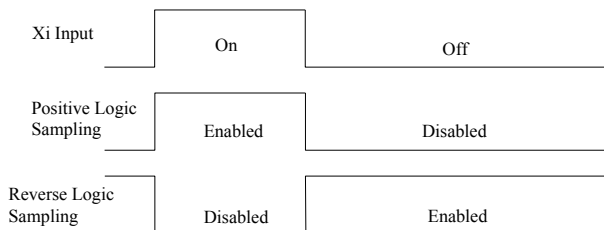

Figure 7-7 Terminal Positive and Negative Logic Sampling

0: enabled when the multi-function input terminal is on, disabled when the multi-function input terminal is off;

1: enabled when the multi-function input terminal is off, disabled when the multi-function input terminal is on

Such function codes are under the bit operation. Set corresponding position as 0 or 1 while setting them. Take F02.15 as example (see the table below):

Table 7-5 Function Code of Bit Operation

Item	*	X7	X6	X5	X4	X3	X2	X1
Bit	7	6	5	4	3	2	1	0
Value	*	0/1	0/1	0/1	0/1	0/1	0/1	0/1

The 7th bit will not be used. This bit can not be set and the displayed value does not have any meaning.

For example: set X1 to negative logic by setting its corresponding bit 0 as 1, i.e., F02.15=xxx xxxx1.

Set X1 and X6 to negative logic by setting corresponding bit 0 of X1 and corresponding bit of X6 as 1, i.e., 02.15=xx1 xxxx1.

★ This function is used for matching with the logic of other peripherals

No.	Function	Range	Unit	Default	Type
F02.17	Filter Times of Numeric Input Terminal	0-100, 0 for No Filter, n for sampling once every n ms		2	○

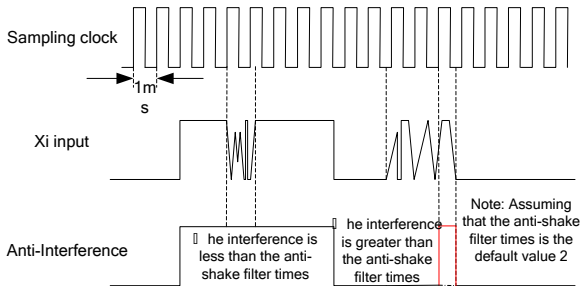

Note: Assuming that anti-shake filter times is the default value 2

Figure 7-8 Terminal Filter Sampling

Because multi-function input terminals adopt level triggered mode or pulse triggered

mode, when inverter is reading terminal status, the multi-function input terminal signal have to be processed by digital filtering in order to avoid interference.

★ This code does not need to be adjusted on general conditions. When an adjustment is required, please note the relations between filter times and lasting time when terminal is on. It is to avoid that inverter is easy to be interfered with due to insufficient filter times, or slow response or command loss due to too many filter times.

No.	Function	Range	Unit	Default	Type
F02.18	X1 Effective Delay Time	0.000 - 30.000	s	0.000	●
F02.19	X1 Ineffective Delay Time	0.000 - 30.000	s	0.000	●
F02.20	X2 Effective Delay Time	0.000 - 30.000	s	0.000	●
F02.21	X2 Ineffective Delay Time	0.000 - 30.000	s	0.000	●
F02.22	X3 Effective Delay Time	0.000 - 30.000	s	0.000	●
F02.23	X3 Ineffective Delay Time	0.000 - 30.000	s	0.000	●
F02.24	X4 Effective Delay Time	0.000 - 30.000	s	0.000	●
F02.25	X4 Ineffective Delay Time	0.000 - 30.000	s	0.000	●

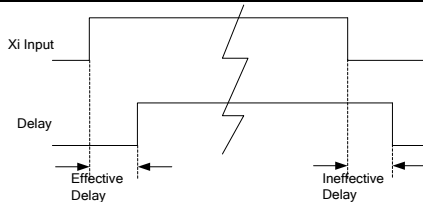

Figure 7-9 Terminal Delay Sampling

The terminal will delay to response according to the function code setting when the function terminal status changes. At present, terminals X1 - X4 support this function. Specific actions: this function will be active after the function terminal changes from disabled status to enabled status and the effective delay time is reached; this function terminal becomes inactive after the function terminal changes from enabled status to disabled status and the ineffective delay time is reached.

★ If the function code is set as 0.000s, the delay is disabled accordingly.

No.	Function	Range	Unit	Default	Type
F02.26	Minimum Input Pulse Frequency	0.00 - Maximum Input Pulse Frequency F02.28	kHz	0.00	●
F02.27	Setting Corresponding to Minimum Input	-100.0 - +100.0	%	0.0	●
F02.28	Maximum Input Pulse Frequency	0.01 - 100.00	kHz	50.00	●
F02.29	Setting Corresponding to Maximum Input	-100.0 - +100.0	%	100.0	●
F02.30	Pulse Input Filter Time	0.00 - 10.00	s	0.10	●

EM500 inverter supports high-speed pulse input (HDI) function, and terminal X7 is shared. F02.26 - F02.30 are used to set the pulse filter time and corresponding offset curve.

As indicated in Figure 7-10, the system realizes the line offset through the setting of the two points (F02.26, F02.27) and (F02.28, F02.29) according to the input pulse frequency size, and the input outside the frequency range will be cut off.

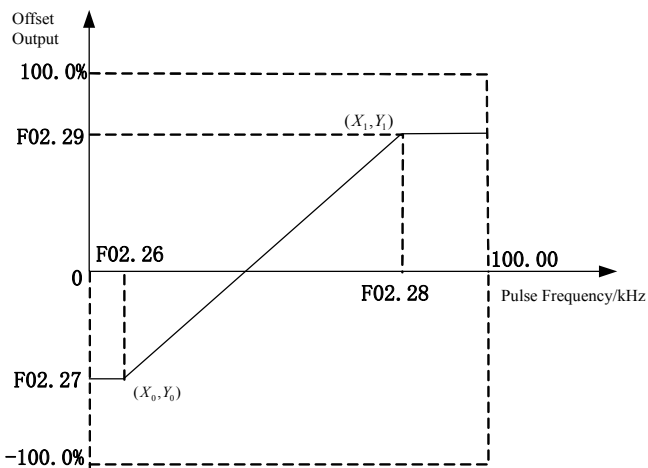

Figure 7-10 High-Speed Pulse Input Offset Curve

When input pulse frequency changes fast or the system does not need to make a quick response to the input pulse, user may properly increase the filter time to stabilize the system.

No.	Function	Range	Unit	Default	Type
F02.31	Analog Input Function	Ones Place: AI1 0: Analog Input 1: Numeric Input (0 for less than 1V, 1 for over 3V, contrary to the last time for 1V-3V) Tens Place: AI2 0: Analog Input 1: Numeric Input (the same as above) Hundreds Place: AI3 0: Analog Input 1: Numeric Input (the same as above) Thousands Place: AI4 (expansion card) 0: Analog Input 1: Numeric Input (the same as above)		0000D	○

Analog input terminals AI1 - AI4 of EM500 inverter can be used as numeric terminals. User only needs to set them as 1. If terminal AI2 is used as a numeric terminal, i.e., F02.31=xx1x, its analog input and numeric logic are switched as follows:

- When the terminal input voltage <1V, corresponding logic status is disabled;
- When the terminal input voltage >3V, the corresponding logic status is enable;
- When the terminal input voltage falls between 1V and 3V, corresponding logic remains.

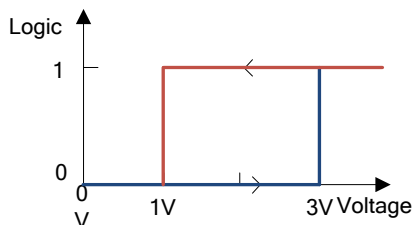

Figure 7-11 Analog Input Terminal Voltage and Present Logic Status Relationship

Diagram

If the terminal is used as an analog input terminal, user may set the filter time and corresponding offset curve through F02.32 - F02.60. AI1 - AI4 can be set respectively.

No.	Function	Range	Unit	Default	Type
F02.32	Analog Input Curve Options	Ones Place: AI1 Curve 0: Curve 1 1: Curve 2 2: Curve 3 3: Curve 4 Tens Place: AI2 Curve 0: Curve 1 1: Curve 2 2: Curve 3 3: Curve 4 Hundreds Place: AI3 Curve 0: Curve 1 1: Curve 2 2: Curve 3 3: Curve 4 Thousands Place: AI4 Curve 0: Curve 1 1: Curve 2 2: Curve 3 3: Curve 4		3210D	○
F02.33	Minimum Input of Curve 1	0.00 - F02.35	V	0.10	●
F02.34	Setting Corresponding to Minimum Input of Curve 1	-100.0 - +100.0	%	0.0	●
F02.35	Maximum Input of Curve 1	F02.33 - 10.00	V	9.90	●
F02.36	Setting Corresponding to Maximum Input of Curve 1	-100.0 - +100.0	%	100.0	●
F02.37	Minimum Input of Curve 2	-10.00 - F02.39	V	0.10	●
F02.38	Setting Corresponding to Minimum Input of Curve 2	-100.0 - +100.0	%	0.0	●
F02.39	Maximum Input of Curve 2	F02.37 - 10.00	V	9.90	●
F02.40	Setting Corresponding to	-100.0 - +100.0	%	100.0	●

	Maximum Input of Curve 2				
F02.41	Minimum Input of Curve 3	0.00 - F02.43	V	0.10	●
F02.42	Setting Corresponding to Minimum Input of Curve 3	-100.0 - +100.0	%	0.0	●
F02.43	Input of Inflexion 1 of Curve 3	F02.41 - F02.45	V	2.50	●
F02.44	Setting Corresponding to Input of Inflexion 1 of Curve 3	-100.0 - +100.0	%	25.0	●
F02.45	Input of Inflexion 2 of Curve 3	F02.43 - F02.47	V	7.50	●
F02.46	Setting Corresponding to Input of Inflexion 2 of Curve 3	-100.0 - +100.0	%	75.0	●
F02.47	Maximum Input of Curve 3	F02.45 - 10.00	V	9.90	●
F02.48	Setting Corresponding to Maximum Input of Curve 3	-100.0 - +100.0	%	100.0	●
F02.49	Minimum Input of Curve 4	-10.00 - F02.51	V	-9.90	●
F02.50	Setting Corresponding to Minimum Input of Curve 4	-100.0 - +100.0	%	-100.0	●
F02.51	Input of Inflexion 1 of Curve 4	F02.49 - F02.53	V	-5.00	●
F02.52	Setting Corresponding to Input of Inflexion 1 of Curve 4	-100.0 - +100.0	%	-50.0	●
F02.53	Input of Inflexion 2 of Curve 4	F02.51 - F02.55	V	5.00	●
F02.54	Setting Corresponding to Input of Inflexion 2 of Curve 4	-100.0 - +100.0	%	50.0	●
F02.55	Maximum Input of Curve 4	F02.53 - 10.00	V	9.90	●
F02.56	Setting Corresponding to Maximum Input of Curve 4	-100.0 - +100.0	%	100.0	●
F02.57	AI1 Filter Time	0.00 - 10.00	s	0.10	●
F02.58	AI2 Filter Time	0.00 - 10.00	s	0.10	●
F02.59	AI3 Filter Time	0.00 - 10.00	s	0.10	●
F02.60	AI4 Filter Time (Expansion Card)	0.00 - 10.00	s	0.10	●

F02.32 is used to select the offset curve corresponding to each analog input terminal and there are 4 groups of offset curves available for selection. Of the 4 groups of curves, curves 1 and 2 are of two-point offset type, and curves 3 and 4 are of four-point offset type; the minimum input voltage of curves 2 and 4 can be as low as -10V and meet the requirements of AI4 input. After having selected the offset curve, user may set corresponding function code to meet the input requirements. It shall have the same meanings as HDI. See F02.26 - F02.29 for details.

User may properly adjust the filter time according to the analog input status and the actual working condition. Please refer to the actual result.

No.	Function	Range	Unit	Default	Type
F02.61	AD Sampling Hysteresis	2 - 50		2	○

User may properly increase the function code, if the input fluctuates greatly due to analog input hysteresis, long input line or severe field interference. The principle of adjustment is to reduce the adjustment as possible

7.4 F03 Group: Output Terminal Function Parameter

EM500 inverter has 2 multi-functional input terminals (Y1 and Y2) and 2 relay output terminals (R1 and R2). In addition, IO expansion card (EC-IO-A1, see Appendix I) is optional and offers 1 multi-functional input output terminals (Y3).

No.	Function	Range	Unit	Default	Type
F03.00	Y1 Output Function	See Table 7-6 Functions of Numeric Multi-Function Input Terminals		1	○
F03.01	Y2 Output Function			3	○
F03.02	R1 Output Function			7	○
F03.03	R2 Output Function			8	○
F03.04	Y3 Output Function (Expansion Card)			0	○

Y1 – Y3, R1 and R2 are 5 numeric multi-function output terminals. By setting the function codes F03.00 - F03.04, user may define the functions of output terminals respectively.

For example, if F03.02=7, the function of terminal R1 is “inverter fault”. If inverter is in the fault status, R1 is in active output status; if inverter is normal status, R1 is in inactive output status. Specific functions available are shown in Table 7-6.

Table 7–6 Numeric Multi-Function Output Terminals

Value	Function	Description
0	No Output	Set “0: No Function” for an unused or fault terminal to prevent false output.
1	Inverter Running (RUN)	When inverter is in slave running, slave stop, JOG running or JOG stop status, present output is active; in other status, present output is inactive.
2	Frequency Reach Range (FAR)	When inverter is in running status and the absolute value of “output frequency – the set frequency” \leq frequency reach detection width (F15.20), present output is active; when inverter is not in running status or the absolute value of “output frequency – the set frequency” $>$ frequency reach range (F15.20), present output is inactive. See the function code F15.20 for details.
3	Output Frequency Detection Range FDT1	When inverter is in running status, and the absolute value of output frequency $>$ output frequency detection range FDT1 (F15.21), then present output is active; when inverter is not in running status, or the absolute value of output frequency \leq output frequency detection range FDT1 (F15.21) - hysteresis FDT1 (F15.22), present output is inactive; for other status, present output status remains unchanged. See the Function Codes F15.21 and F15.22 for details
4	Output Frequency Detection Range FDT2	When inverter is in running status, and the absolute value of output frequency $>$ output frequency detection range FDT1 (F15.23), then present output is active; when inverter is not in running status, or the absolute value of output frequency \leq output frequency detection range FDT2 (F15.23) - hysteresis FDT1 (F15.24), present output is inactive; for other status, present output status remains unchanged. See the function codes F15.23 and F15.24 for details.
5	Reverse Running (REV)	When the running direction and acceleration/deceleration status of inverter are reverse acceleration, reverse deceleration or reverse constant speed, present output is active.
6	JOG Running	When inverter is in JOG running or JOG stop status, present output is active. In other status, present output is inactive

7	Inverter Fault	When inverter is in fault status, present output is active; in other status, present output is inactive.
8	Inverter Ready	When inverter is ready for running after it is powered on and finishes initialization without any abnormality, present output is active.
9	Upper Limit Frequency Reach	When inverter is in JOG or slave running status, output frequency (F18.00) \geq the upper limit frequency (F00.17 F00.18) and the set frequency (F18.01) \geq the upper limit frequency (F00.17 F00.18), present output is active. Otherwise, present output is inactive.
10	Lower Limit Frequency Reach	When inverter is in JOG or slave running status, output frequency (F18.00) \leq the lower limit frequency (F00.19) and the set frequency (F18.01) \leq the lower limit frequency (F00.19), present output is active. Otherwise, present output is inactive.
11	Current Limit Reach	When output current (F18.06) \geq current limit level (F07.12), present output is active. When output current (F18.06) \leq current limit level (F07.12) -5.0%, present output is inactive. When the voltage is the intermediate value, present output status remains the same.
12	Overvoltage Stall Voltage Reach	When output voltage (F18.07) \geq Overvoltage stall control voltage (F07.07), present output is active. When output voltage (F18.07) \leq Overvoltage stall control voltage (F07.07) -10V, present output is inactive. When the voltage is the intermediate value, present output status remains the same.
13	Simple PLC Cycle Finished	When the simple PLC running mode is “stop after single running” (F18.15=0), inverter stops after single running, and present output is active; when the simple PLC running mode is “stop after limited times of running” (F18.15=1), inverter stops after running as per F08.16, present output is active; otherwise (run again, simple PLC status reset, etc.), present output is inactive.
14	Set Count Value Reach	When input pulse count value (F18.34) \geq set count value (F16.03), present output is active, otherwise the output is inactive. See the function codes F16.03 - F16.04 for details.
15	Designated Count	When input pulse count value (F18.34) \geq designated count

	Value Reach	value (F16.04), present output is active, otherwise the output is inactive. See the function codes F16.03 - F16.04 for details.
16	Length Reach	When the input pulse conversion value (F18.34) \geq the set count value (F16.01), present output is active, otherwise the output is inactive. See the function codes F16.01 - F16.02 for details.
17	Motor Overload Pre-alarmed	When present motor current \geq motor pre-alarmed factor (F07.02), present output is active. Otherwise, the output is inactive.
18	Inverter Overheating Pre-Alarm	When inverter temperature \geq overheat spot -25°C , the pre-alarmed output is active, otherwise the pre-alarmed output is inactive.
19	PID Feedback Upper Limit Reach	If PID feedback (F18.17) \geq the upper limit of PID output (F09.16) when inverter is running, present output is active. Otherwise, present output is inactive.
20	PID Feedback Lower Limit Reach	If PID feedback (F18.17) \leq the lower limit of PID output (F09.17) when inverter is running, present output is active. Otherwise, present output is inactive.
21	Analog Input Level Detection ADT1	If the selected analog input channel \geq the analog input level detection (F15.26/28), corresponding output is active; if the selected analog input channel \leq the analog input level detection (F15.26/28) – the hysteresis (F15.27/29), present output is inactive; When inverter is in other status except the two above, present output status remains the same. See F15.25 - F15.29 for details.
22	Analog Input Level Detection ADT2	
23	Not Used	
24	Undervoltage Status	When DC bus voltage (F18.08) \leq undervoltage stall control voltage (F07.08), present output is active. When DC bus voltage (F18.08) \geq Judgment Voltage at Power Failure Ending (F07.09), and maintenance time \geq judgment delay time at power failure ending (F07.10), present output is inactive.
25	Motor Overload Pre-alarmed	When present motor temperature (F18.38) \geq motor overheating pre-alarmed threshold (F07.05), present output is active. Otherwise, the output is inactive. See F07.03 - F07.05 for details.

26	Set Time Reach	When the timed running time is reached, present output is active. Otherwise, present output is inactive. See F16.09 for details.
27	Zero Speed Running	When inverter is in JOG or slave running status, and output frequency (F18.00) \leq zero servo start frequency (F04.29), present output is active. Otherwise, present output is inactive.
28~48	Not Used	
38	Off Loading	The inverter is in the Loss Of Loading state
49	Inlet Valve Control	Air compressor dedicated function, this function is used to control the air compressor inlet valve.
50	Fan Start-stop Control Signals	Air compressor dedicated function, this function is used to control the air compressor start and stop
51	Phase Angle Of Arrival	Phase Sequence Phase Detection Card-specific function, which is used to indicate that the set phase angle difference has been reached.
52	Inverter Startup Is Completed	Phase sequence phase detection card special function, when using a phase-sequence phase detection card function, this function is used to control the output of the inverter circuit.
53	Switch to The Power frequency	Phase sequence phase detection card special function, when using a phase-sequence phase detection card function,, This function is used to control the contactor of Power frequency switch to
54~55	Not Used	
56	Pipeline Overpressure Alarm	Water supply application-specific function, when the pipeline is meet the over-pressure conditions, the terminal output is valid
57	Under-voltage Alarm	Water supply application-specific function, when the pipeline is meet the under-pressure conditions, the terminal output is valid
58	Water Shortage Alarm	Water supply application-specific function, When it have Inlet pool water level control, and includes lack of water level switch, disconnect the lack of water level switch ,the output function is valid.
59	Dormancy Instructions	Water supply application-specific function, This function output is valid when the water pump meets the sleep

		condition and sleep is completed.
60	The Pump Rotation Instructions	Water supply application-specific function, This function output is valid when the rotary pump to meet ahead of the output
61	The Standby Pressure Operation Instructions	Water supply application-specific function, This function output is valid when the Inlet pool water level control is effective and water level given is standby pressure
62	Not Used	
63	H Pump Control	Water supply application-specific function, This function output is valid when the H pump is action
64	I pump control	Water supply application-specific function, This function output is valid when the I pump is action
65~66	Not Used	
67	Brake Control	Winding application-specific function, the function output is valid when the brake is valid,
68	Material supply disruptions Detection Output	Winding application-specific function, the function output is valid when the Material supply disruptions is happened
69	FDT1 Lower Bound (Impulse)	The function is similar to 3/4 ,The difference is that the output is valid only after the frequency is lower than the "set-hysteresis" and is automatically disabled for keep a period of time. If set to monopulse output, the time is set by F03.17 ~ F03.20; if the output is level of output, the time defaults to 0.1s.
70	FDT2 Lower Bound (Impulse)	
71	FDT1 Lower Bound (Impulse When JOG Is Invalid)	The function is similar to 69/70, The difference is that the output is invalid in JOG
72	FDT1 Lower Bound (Impulse When JOG Is Invalid)	

If the two multi-function output ports are of OC output type and the common terminal of the output is COM. If the selected function is inactive, the electronic switch is OFF; if the selected function is active, the electronic switch is ON. OC can be powered by internal power supply, as shown in Figure 7-12 (a), or by external power supply, as

shown in Figure 7-12 (b). For external power supply, the required voltage range is 12 - 30 V.

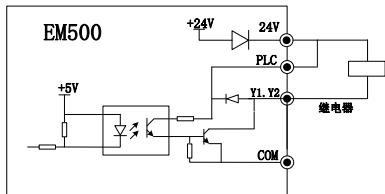

a) Internal Power Supply

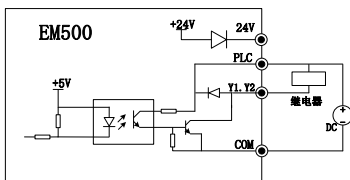

b) External Power Supply

Figure 7-12 Power Supply Mode of Multi-Function Terminal

The relay output is provided by the internal relay of inverter; the relay has 1 group of NO contacts and 1 group of NC contacts; when the selected function is inactive, EB-EC is NC and EA-EC is NO (Refer to Figure 7-13); when the selected function is active, the internal relay coil is powered on, EB-EC is off and EA-EC is on.

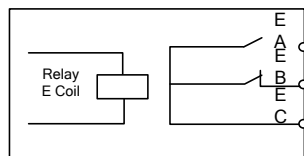

Figure 7-13 Relay Contactor

No.	Function	Range								Unit	Default	Type
		D7	D6	D5	D4	D3	D2	D1	D0			
F03.05	Output Signal Type	*	*	*	*	R2	R1	Y2	Y1		*0000	○
		0: Level				1: Monopulse						

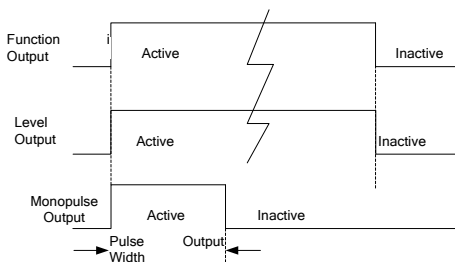

Figure 7-14 Numeric Output Terminal Level and Monopulse Output

Numeric output terminals Y1 and Y2, and relay output terminals R1 and R2 have two output types, level and monopulse (see Figure 7-14). For level output, the function

terminal’s output status is consistent with its function status; for monopulse output, the active level of certain pulse width can be output only when the function is enabled.

This function code is of bit operation type. For specific settings, please refer to table 7-5 of the description part for F02.15.

No.	Function	Range	Unit	Default	Type
F03.06	Positive/Negative Logic of Numeric Output	D7 D6 D5 D4 D3 D2 D1 D0		00000	○
		* * * Y3 R2 R1 Y2 Y1			
		0: Positive Logic, Enabled at On/Disabled at Off 1: Negative Logic, Disabled at On/Enabled at Off			

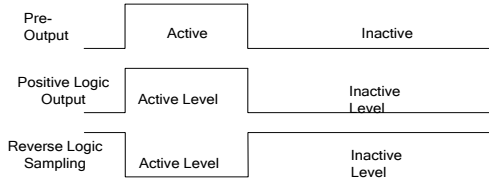

Figure 7-15 Positive and Negative Logic Output of Numeric Output Terminal

According to the design, numeric multi-function output terminal status has two output logics:

0: Positive logic, if the function is on, the multi-function output terminal outputs active level; if the function is off, the multi-function output terminal outputs inactive level.

1: Negative logic, if the function is on, the multi-function output terminal outputs inactive level; if the function is off, the multi-function output terminal outputs active level.

This function code is of bit operation type. For specific settings, please refer to table 7-5 of F02.15.

★ This function is used for matching with the logic of other peripherals

Actual level: Y1/Y2, the default active level is low level; the default actual level of R1/R2 is high level.

No.	Function	Range	Unit	Default	Type
F03.07	Y2 Output Type	0: Common Numeric Output 1: High-Frequency Pulse Output		0	○

EM500 inverter supports the high-speed pulse output (HDO) function, which is similar to the analog output function. The output of inverter is in pulse of different frequency sizes other than voltage values.

No.	Function	Range								Unit	Default	Type
		D7	D6	D5	D4	D3	D2	D1	D0			
F03.08	Output Status Control at JOG	*	*	*	REV	FDT2	FDT1	FAR	RUN		00000	○
		0: Enabled at JOG										
		1: Disabled at JOG										

When inverter is in jog running, user does not need DO to output some status, so setting this function code as 1 to shield corresponding output. If F03.08=xxx1x when FAR is in active output status, then the actually selected output terminal does not output the active level.

This function code is of bit operation type. For specific settings, please refer to table 7-5 of F02.15.

No.	Function	Range	Unit	Default	Type
F03.09	Y1 Effective Delay Time	0.000 - 30.000	s	0.000	●
F03.10	Y1 Ineffective Delay Time	0.000 - 30.000	s	0.000	●
F03.11	Y2 Effective Delay Time	0.000 - 30.000	s	0.000	●
F03.12	Y2 Ineffective Delay Time	0.000 - 30.000	s	0.000	●
F03.13	R1 Effective Delay Time	0.000 - 30.000	s	0.000	●
F03.14	R1 Ineffective Delay Time	0.000 - 30.000	s </td <td>0.000</td> <td>●</td>	0.000	●
F03.15	R2 Effective Delay Time	0.000 - 30.000	s	0.000	●
F03.16	R2 Ineffective Delay Time	0.000 - 30.000	s	0.000	●

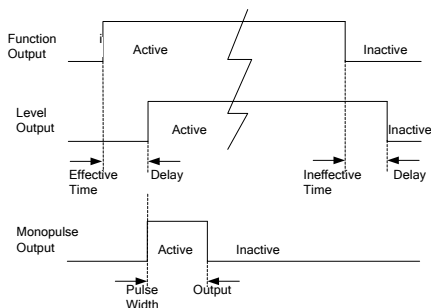

Figure 7-16 Numeric Output Terminal Level and Monopulse Output

The terminal will delay to response according to the function code setting when the function terminal changes. At present, terminals Y1/Y2 and R1/R2 support this function. Specific actions: corresponding output terminal outputs active level only when the function terminal changes from disabled status to enabled status and the effective delay time is reached; corresponding output terminal outputs inactive level only when the function terminal changes from enabled status to disabled status and the ineffective delay time is reached.

★ If the function code is set as 0.000s, the delay function will be disabled.

No.	Function	Range	Unit	Default	Type
F03.17	Y1 Output Monopulse Time	0.001 - 30.000	s	0.250	●
F03.18	Y2 Output Monopulse Time	0.001 - 30.000	s	0.250	●
F03.19	R1 Output Monopulse Time	0.001 - 30.000	s	0.250	●
F03.20	R2 Output Monopulse Time	0.001 - 30.000	s	0.250	●

When the output type of a function output terminal is monopulse output (see F03.05), user may control the active level pulse width by setting monopulse output time to meet various process or control requirements. See Figure 7-14 and Figure 7-16 for details.

No.	Function	Range	Unit	Default	Type
F03.21	Analog Output M1	See Table 7-7 Multi-Function Analog Output Terminals		0	○
F03.22	Analog Output M2			2	○
F03.23	Y2 High-Frequency Pulse Output Function			11	○

M1 and M2 are 2 multi-function analog output terminals and Y2 can be set as a high-speed pulse output terminal (F03.07=1). By setting the function codes F03.21 - F03.23, user may define the functions of output terminals.

For example, if F03.21=0, the function of M1 terminal is to output “Running frequency (absolute value)”, and reflects present value of “Running frequency” (absolute value)” by outputting different voltage values. If the running frequency increases from

0.00 Hz to 50.00 Hz (assuming $F00.16=50.00$), then the default condition is that the M1 output voltage increases from 0.00V to 10.00 V, with the same variation trend as that of the running frequency. Specific functions available are shown in Table 7-7.

Table 7-7 Multi-Function Analog Output Terminals

Value	Function	Description
0	Running frequency (absolute value)	0.00 Hz - Fmax, corresponding output 0.0% - 100.0%
1	Set frequency (absolute value)	0.00 Hz - Fmax, corresponding output 0.0% - 100.0%
2	Output torque (absolute value)	0.0% - 200.0%, corresponding output 0.0% - 100.0%
3	Set torque (absolute value)	0.0% - 200.0%, corresponding output 0.0% - 100.0%
4	Output Current	0.0A - 2*Ie, corresponding output 0.0% - 100.0%
5	Output Voltage	0.0V - 1.5*Ue, corresponding output 0.0% - 100.0%
6	Bus voltage	0V - 1000V, corresponding output 0.0% - 100.0%
7	Output Power	0.00kW - 2*Pe, corresponding output 0.0% - 100.0%
8	AI1	Output the actual input voltage, other than the results after offset 0.0% - 100.0%, corresponding output 0.0% - 100.0%
9	AI2	
10	AI3	
11	AI4 (Expansion Card)	
12	High-Speed Pulse Input	F02.26 - F02.28, corresponding output 0.0% - 100.0%
13	Not Used	
14	The Count Value	0~F16.03 corresponding output F16.10~F16.11
15	Length Value	0~F16.01 corresponding output F16.10~F16.11
16	The PID Output Percentage	-100.0%~100.0% corresponding output 0.0%~100.0%
18	PID Feedback	-100.0%~100.0% corresponding output 0.0%~100.0%
19	PID Is Given	-100.0%~100.0% corresponding output 0.0%~100.0%
20~37	Not Used	
38	The Fan Speed Output	Air compressor special function 0%~100% Corresponding to the maximum frequency inverter for fan

★ Fmax, Maximum Frequency (F00.16)

Ie, Inverter Rated Current (F12.21)

U_e, Inverter Rated Voltage (F12.20)

P_e, Inverter Rated Power (F12.19)

The output of the analog output terminal can be switched through DIP between the voltage signal 0.00V - 10.00 V and the current signal 0.00mA - 20.00mA. For voltage signal, 0.0% - 100.0% corresponds to the output 0.00V - 10.00 V; for current signal, 0.0% - 100.0% corresponds to 0.00mA - 20.00mA. See 3.3.7 Analog Output Terminal Wiring for details.

No.	Function	Range	Unit	Default	Type
F03.24	Maximum Frequency of Y2 High-Frequency Pulse Output	0.00 - 100.00	kHz	50.00	●
F03.25	Minimum Frequency of Y2 High-Frequency Pulse Output	0.00 - 100.00	kHz	0.00	●
F03.26	Filter Time of Y2 High-Frequency Pulse Output	0.00 - 10.00	s	0.10	●

High-Frequency Pulse Output Rating: As indicated in Table 7-7, for output of 100.0%, the setting shall correspond to maximum output frequency; for output of 0.0%, the setting shall correspond to minimum output frequency; output between 100.0% and 0.0% maintains a linear relationship with setting values.

F03.26 performs first-order inertia filter with respect to output.

No.	Function	Range	Unit	Default	Type
F03.27	M1 Output Offset	-100.0 - 100.0	%	0.0	●
F03.28	M1 Output Gain	-10.00 - 10.00		1.00	●
F03.29	M2 Output Offset	-100.0 - 100.0	%	0.0	●
F03.30	M2 Output Gain	-10.00 - 10.00		1.00	●

These function codes are used to correct the zero shift and output amplitude deviation of the analog output generally, and they can also be used to define the desired AO output curve to meet different instrument or other requirements. If use “b” for offset, “k” for gain, “Y” for actual output, and “X” for standard output, then the actual output is: $Y=kX + b$.



1. In order to meet the requirements of various instruments or peripherals, the full-scale voltage of M1 and M2 is 10.9V actually and the full-scale current is 22mA actually.
2. The default settings of M1 and M2 are 0.00 - 10.00 V.
3. Please use a multimeter to test the idling output of terminals M1 and M2, if there is requirement on the accuracy of the analog output.

7.5 F04 Group: Start/Stop Control Parameter

No.	Function	Range	Unit	Default	Type
F04.00	Start Mode	0: Start Directly 1: Rotation Speed Tracking Start		0	○

F04.00=0: Start Directly

Inverter starts with DC brake (not available if F04.04=0), conducts the pre-excitation (not available if F04.07=0), starts at the start frequency, and enters the set frequency running after the retention time of the start frequency.

F04.00=1: Rotation Speed Tracking Start

Inverter will first perform the rotation speed tracking (size and direction) at startup, and start up smoothly from the actual rotation frequency of present motor

No.	Function	Range	Unit	Default	Type
F04.01	Start Frequency	0.00 - 10.00	Hz	0.00	○
F04.02	Start Frequency Retention Time	0.00 - 60.00, Disabled at 0.00	s	0.00	○

Set an appropriate start frequency, in order to guarantee motor torque at start. In order to enable motor to make magnetic flux fully, it's required to maintain motor's start frequency for certain time. The start frequency F04.01 is not limited by the lower limit frequency.

No.	Function	Range	Unit	Default	Type
F04.03	DC Brake Current at Start	0.0 - 100.0 (100.0= Motor Rated Current)	%	100.0	○
F04.04	DC Brake Time at Start	0.00 - 30.00	s	0.00	○

Before inverter starts, motor may run at low speed or reverse. Starting inverter at

this time immediately may result in overcurrent fault. In order to avoid such a fault, add the link of DC brake at first prior to inverter start to stop motor, and then start inverter to the set frequency according to the set direction.

Different values of F04.03 may realize different start DC brake torques.

By setting the action time of DC brake through F04.04, inverter starts immediately after the set time is out. If F04.04=0.00, DC brake is disabled at start.

★ The process of starting DC brake is shown in Figure 7-18.



This function may be enabled when the single inverter serves multiple motors and inverter is starting

No.	Function	Range	Unit	Default	Type
F04.06	Pre-Excitation Current	50.0 - 500.0 (100.0=Idling Current)	%	100.0	○
F04.07	Pre-Excitation Time	0.00 - 10.00	s	0.10	○

Inverter develops a magnetic field as the set pre-excitation current, and starts running after the set pre-excitation time (F04.07) is out. If the set pre-excitation is 0, inverter will start directly without the pre-excitation link.

F04.06 pre-excitation current is a percentage relative to motor's rated no load current.

No.	Function	Range	Unit	Default	Type
F04.08	Rotation Speed Tracking Method	0: Start from Maximum Frequency 1: Start from Stop Frequency 2: Start from Power frequency		0	○

When the starting mode is selected as the torque tracking start (F04.00=1), inverter will perform the torque tracking as per the setting through F04.08 at start. Please select a proper mode according to the working condition, so as to better track present motor running frequency.

This mode can be selected when inverter starts tracking downwards from the maximum frequency (F04.08=0) and the running status of motor is completely unsure (motor is in rotation status when inverter is powered on);

If F04.08=1, it means that inverter starts tracking from the stop frequency. Generally, this mode is selected;

If F04.08=2, it means that inverter starts tracking from the power frequency. This mode can be selected if the power frequency changes to the frequency conversion.

No.	Function	Range	Unit	Default	Type
F04.09	Rise Time of Rotation Speed Tracking Voltage	0.05 - 10.00	s	0.30	○
F04.10	Deceleration Time of Rotation Speed Tracking	0.1 - 20.0	s	2.0	○
F04.11	Rotation Speed Tracking Current	30.0 - 150.0 (100.0=Inverter Rated Current)	%	60.0	●
F04.12	Rotation Speed Tracking Compensation Gain	1.00 - 1.30		1.05	●

F04.09: Rise Speed of Rotation Speed Tracking Voltage.

F04.10: The scanning speed starting from the set frequency to downward tracking at the torque tracking; this time refers to the period that the rated frequency decreases to 0.00 Hz.

F04.11: Tracking current, which is a ratio relative to inverter rated current. The lower the current is, the smaller the impact of motor will be, so is the tracking accuracy. However, if the current is set as an excessively low value, the tracking results may be inaccurate, which result in the start failure. The higher the current is, the fewer motor rotation speed drop at tracking will be; please increase the set value for heavy load tracking occasions.

F04.12: Tracking intensity. Generally, the default is usually adopted. This value may be increased when the tracking speed is high and results in a voltage fault.

No.	Function	Range	Unit	Default	Type
F04.14	Acceleration/Deceleration Mode	0: Linear Acceleration/Deceleration 1: S Curve Acceleration/Deceleration		0	○
F04.15	S Curve Start	0.00 - System acceleration time/2	s	1.00	●

	Section Time at Acceleration	(F15.13=0) 0.0 - System acceleration time/2 (F15.13=1) 0 - System acceleration time/2 (F15.13=2)			
F04.16	S Curve End Section Time at Acceleration	0.00 - System acceleration time/2 (F15.13=0) 0.0 - System acceleration time/2 (F15.13=1) 0 - System acceleration time/2 (F15.13=2)	s	1.00	●
F04.17	S Curve Start Section Time at Deceleration	0.00 - System deceleration time/2 (F15.13=0) 0.0 - System deceleration time/2 (F15.13=1) 0 - System deceleration time/2 (F15.13=2)	s	1.00	●
F04.18	S Curve End Section Time at Deceleration	0.00 - System deceleration time/2 (F15.13=0) 0.0 - System deceleration time/2 (F15.13=1) 0 - System deceleration time/2 (F15.13=2)	s	1.00	●

F04.14=0: Linear Acceleration/Deceleration

Output frequency increases or decreases in a straight line progressively and the default acceleration/deceleration time is set through the function codes F00.14 and F00.15.

F04.14=1: S curve acceleration/deceleration

During the acceleration in Figure 7–15: t1 is the value set through F04.15 and t2 is the value set through F04.16; during the deceleration: t3 is the value set through F04.17 and t4 is the value set through F04.18. During the time period of t1 and t2, and t3 and t4, the gradient for output frequency changes is fixed.

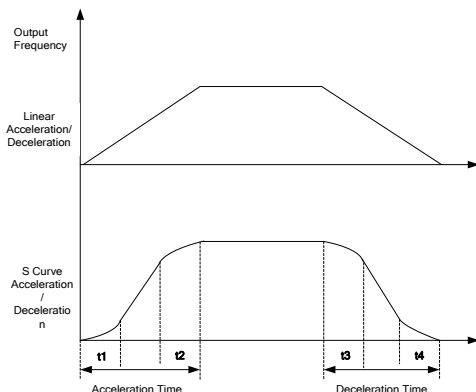

7-17 Acceleration/Deceleration Time Control

No.	Function	Range	Unit	Default	Type
F04.19	Stop Mode	0: Ramp-To-Stop 1: Coast-to-Stop		0	○

F04.19=0: Ramp-To-Stop

Motor ramps to stop after the set deceleration time is out [default setting is as per F00.15 (deceleration time 1)]

F04.19=1: Coast-to-Stop

After enabling the stop command, inverter will stop output immediately and motor will coast to stop. Specific stop time depends upon the inertia of motor and the load.

If the coast-to-stop terminal is set, inverter coasts to stop immediately after the coast-to-stop terminal is enabled; inverter will not run again even if the terminal is disabled unless a run command is inputted.

No.	Function	Range	Unit	Default	Type
F04.20	DC Brake Start Frequency at Stop	0.00 - Maximum Frequency F00.16	Hz	0.00	○
F04.21	DC Brake Current at Stop	0.0-150.0 (100.0= Motor Rated Current)	%	100.0	○
F04.22	DC Brake Time at Stop	0.00 - 30.00, Disabled at 0.00	s	0.00	○
F04.23	DC Brake Field	0.00 - 30.00	s	0.50	○

	Weakening Time at Stop				
--	------------------------	--	--	--	--

F04.20 set the starting DC brake frequency during ramp-to-stop. During ramp-to-stop, once output frequency is lower than this value, inverter will start DC brake if the DC brake time at stop is not set as 0.

Different values of F04.21 may realize different DC brake torques at stop.

F04.22 is used to set the action time of DC brake at stop. If F04.22=0.00, DC brake at stop will be disabled. If there is also a signal of DC brake from an external terminal, then the DC brake time at stop shall be the bigger of the following two: the action time of DC brake signal of an external terminal, and the time set through F04.22.

For 04.23, inverter starts DC brake in ramp-to-stop when output frequency reaches the value set through F04.20 and the time set by F04.24 is reached.

The process of DC brake at stop is shown in Figure 7-19.

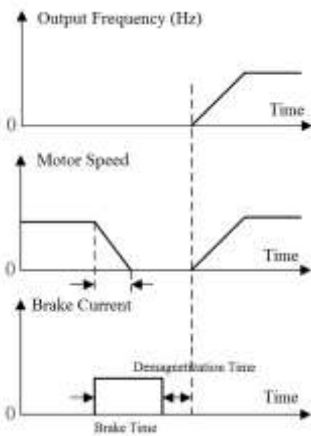

Figure 7-18 Start Process of DC Brake

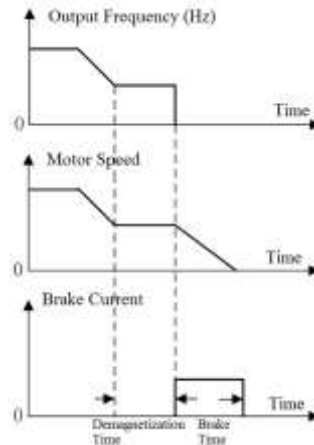

Figure 7-19 Stop Process of DC Brake



Generally, for a heavy load, the deceleration operation may not stop motor completely after the deceleration time is out due to inertia; extending the DC brake time at stop or increasing DC brake current at stop can stop motor

No.	Function	Range	Unit	Default	Type
F04.24	Magnetic Flux Brake Gain	100 – 150 (100: No Magnetic Flux Brake)		100	○

When magnetic flux brake is enabled (F04.24>100), inverter may enable motor for rapid deceleration by the method of increasing the magnetic flux of motor. At this time, the electric energy in motor brake process can be transformed into thermal energy

The magnetic flux brake can be used to realize the rapid deceleration, but output current may be large; user may set the magnetic flux brake intensity (F04.24) for limit protection so as to avoid damaging motor; if the magnetic flux brake is disabled, the deceleration time will be long, but output current is small.

No.	Function	Range	Unit	Default	Type
F04.26	Start Mode after Fault/Coast to Stop	0: Start as per the Set Mode of F04.00 1: Rotation Speed Tracking Start		0	○

As for the start mode after fault or coast to stop, the default is the start as per the setting of F04.00 (F04.26=0), but user may select the torque tracking start (F04.26=1) in a fixed way. For various stop modes, see the function code F04.00.

No.	Function	Range	Unit	Default	Type
F04.27	Terminal Start Command Reconfirmation	0: Not to Confirm 1: Confirm		0	○

F04.27=0: Not to Confirm

If the running terminal (RUN or F/R) is on and F00.03 is set as 0 or 1, inverter is powered on while enabling or disabling the terminal, or inverter runs directly while the start/stop mode is switched to the terminal.

F04.27=1: Confirm

Close running terminal, set F00.03 as 0 or 1, inverter cannot run directly when start or stop by the terminal at power-on or when the starting or stop mode is switched to terminal mode.

No.	Function	Range	Unit	Default	Type
F04.30	Initial Position Search after Power-on or Fault	0: Disabled 1: Enabled		0	●

When present motor is a synchronous motor (eg: F01.00=2) and in the VF control mode, the initial angle is crucial to the control performance; especially, motor may reverse at the moment of start. Therefore, the default of inverter is to perform the initial position search after power-on or fault, so as to obtain better control performance.

7.6 F05 Group: VF Control Parameter

This group of function codes is only valid for V/F control and not valid for vector control.

V/F control applies to the general loads like fan and water pump, or to the occasion “one inverter shared by multiple motors” or the occasion where there is high difference between inverter power and motor power

No.	Function	Range	Unit	Default	Type
F05.00	V/F Curve Setting	0: Straight Line V/F 1: Multi-Dot Polyline V/F 2: VF to the 1.3rd 3: VF to the 1.7th 4: Square V/F 5: VF Complete Split Mode (Ud=0, Uq=K*t=Split voltage source voltage) 6: VF Half-Split Mode (Ud=0, Uq=K*t=F/Fe*2*Split voltage source voltage)		0	○

F05.00=0: Straight Line V/F

Applies to general constant torque load

F05.00=1: Multi-Pot V/F

Applicable for dehydrator, centrifuge, crane and other special loads. By setting parameters of F05.01 - F05.06, user may obtain a user-defined V/F curve.

F05.00=2/3: VF to the 1.3rd / VF to the 1.7th

Refers to a VF curve that goes between the linear VF and the square VF.

F05.00=4: Square V/F

Applies to centrifugal loads like fan and water pump.

F05.00=5: VF Complete Split Mode

Inverter output frequency and output voltage are independent, with output frequency determined by the frequency source and output voltage determined by F05.07 (Voltage Source of VF Separation Mode).

This mode is generally used for occasions such as induction heating, inversion power supply and torque motor control.

F05.00=6: VF Half-Split Mode

In this mode, V and F are proportional. However, the proportion can be set through the power supply source (F05.07) and this proportion has something to do with motor rated voltage and rated frequency of F1 group.

Assuming that the power supply source is X (0 - 100%), the relationship between output voltage V and frequency F is as follows:

$$V/F=2*X* (\text{motor rated voltage}) / (\text{motor rated frequency})$$

No.	Function	Range	Unit	Default	Type
F05.01	Multipoint VF Frequency Point F1	0.00 - F05.03	Hz	0.50	●
F05.02	Multipoint VF Voltage Point V1	0.0 - 100.0 (100.0= Rated Voltage)	%	1.0	●
F05.03	Multipoint VF Frequency Point F2	F05.01 - F05.05	Hz	2.00	●
F05.04	Multipoint VF Voltage Point V2	0.0 - 100.0	%	4.0	●
F05.05	Multipoint VF Frequency Point F3	F05.03 - Motor Rated Frequency (Reference Frequency)	Hz	5.00	●
F05.06	Multipoint VF Voltage Point V3	0.0 - 100.0	%	10.0	●

Parameters of the function codes F05.05 - F05.10 will be enabled if Multi-Dot Polyline V/F is selected (F05.00=1).

A user-defined V/F curve is determined by the curve set with the input frequency percentage and output voltage percentage, and it is linearized at different segments in different input ranges.

Motor rated frequency is the ultimate frequency reached by the V/F curve and also

the frequency at maximum voltage output. The input frequency percentage: if motor rated frequency is the input frequency, the percentage is 100.0%; output voltage percentage: if motor rated voltage is output voltage (U_e), the percentage is 100.0%.



The relationship between the three voltage points and the frequency point must meet the following requirements: $V1 < V2 < V3$, $F1 < F2 < F3$.

An excessive slope of the V/F curve may result in an “overcurrent” fault.

Especially, an excessively high voltage at low frequency may cause motor to be overheated or burn motor and inverter may get in overcurrent stall or overcurrent protection.

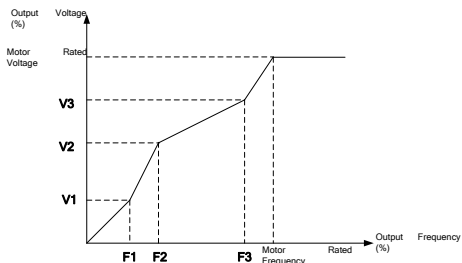

Figure 7-20 Multi-Dot Polyline V/F Curve

No.	Function	Range	Unit	Default	Type
F05.07	Voltage Source of VF Separation Mode	0: Numeric Setting of VF Separation Voltage 1: AI1 2: AI2 3: AI3 4: High-Frequency Pulse (X7) 5: PID 6: Communication Percentage Setting Note: Motor Rated Voltage is 100%		0	○
F05.08	Numeric Setting of VF Separation Voltage	0.0 - 100.0 (100.0=Motor Rated Voltage)	%	0.0	●

The VF separation is generally used for occasions such as induction heating, inversion power supply and torque motor control.

In VF separation control, output frequency can be set by F05.08 as well as analog input, high speed pulse, PID or communication setting. In nonnumeric setting, 100% of each setting refers to motor's rated voltage. When the set percentage of analog output is negative, then take the set absolute value as effective value.

F05.07=0: Numeric Setting of VF Separation Voltage (F05.08)

VF separation output voltage is determined by the numeric setting of VF separation voltage (F05.08).

F05.07=1: AI1

F05.07=2: AI2

F05.07=3: AI3

F05.07=4: High-Frequency Pulse Input (X7)

VF separation output voltage is determined by AI/HDI (percentage) * Numeric Setting of VF Separation Voltage (F05.08).

Please refer to the description of F00.04 for detailed explanations of AI1-AI3 and X7. F00.04 has the same meanings as AI1-AI3 and X7. 100.00% is the percentage inputted through F05.08 (Numeric Setting of VF Separation Voltage).

F05.07=5: Process PID

VF separation output voltage is determined by the process PID (see 7.10).

F05.07=6: Communication Percentage Setting

The VF separation output voltage is determined through communication.

- If inverter is under master-slave communication control (F10.05=1) and present inverter is a slave (F10.06=0), the VF separation output voltage is set as “700FH (Communication Percentage Setting) * F01.02 (Motor Rated Voltage) * F10.08 (Receiving Proportionality Factor of Slave)”. The range of 700FH is 0.00% to 100.00%. See Table 12-2 for details.
- For general communication (F10.05=0), VF separation output voltage is set as “7006H (VF separation mode voltage setting) * F05.08 (Numeric Setting of VF Separation Voltage)”. The range of 7006H is 0.00% to 100.00%. See Table 12-2 for details.

No.	Function	Range	Unit	Default	Type
F05.09	Rise Time of VF Separation Voltage	0.00 - 60.00	s	2.00	●

The voltage rise time of VF separation is the time that the voltage increases from 0 to motor rated voltage.

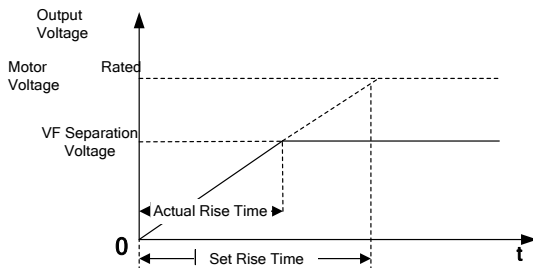

Figure 7-21 Voltage Rise Time of VF Separation

No.	Function	Range	Unit	Default	Type
F05.10	V/F Stator Voltage Drop Compensation Gain	0.00 - 200.00	%	100.00	●

This function code is used to compensate for the voltage drop generated by the rotor resistor and cable, and promote the loading capacity at low frequency of inverter.

No.	Function	Range	Unit	Default	Type
F05.11	V/F Slip Compensation Gain	0.00 - 200.00	%	100.00	●
F05.12	V/F Slip Filter Time	0.00 - 10.00	s	1.00	●

When rotor's speed drops by an increase of load, to ensure the rotor's speed is close to synchronous speed under rated load, slip compensation can be applied, increase the setting value of F05.11.

★ If F05.11=0, the slip compensation is disabled; this parameter is only enabled for the synchronous motor.

When inverter makes a quick start under large inertia, the slip is 100%; after reaching the set frequency, the slip is 0; quick decrease of output frequency would result in overvoltage or overcurrent. F05.02 may mitigate the boost of voltage and current.

No.	Function	Range	Unit	Default	Type
F05.13	Oscillation Suppression Gain	0 - 20000		100	●
F05.14	Oscillation Suppression End Frequency	0.00 - 600.00	Hz	55.00	●

In VVF, adjusting this parameter can suppress motor oscillation. However, do not adjust it or adjust this parameter to a smaller value properly if there is no motor oscillation; in case of apparent oscillation, adjust this parameter to a bigger parameter properly.

No.	Function	Range	Unit	Default	Type
F05.15	Sagging Control Frequency	0.00 - 10.00	Hz	0.00	●

This function is usually applied to the load distribution when multiple motors bear one load.

Inverter output frequency goes down as the load increases; when multiple motors bear the same one load, motor output frequency for the load will decrease more, thus reducing the load of motor and realizing the even load of multiple motors.

This parameter refers to the decline of output frequency when inverter is in rated load output.

No.	Function	Range	Unit	Default	Type
F05.16	Energy Saving Rate	0.00 - 50.00	%	0.00	●
F05.17	Energy Saving Actuation Time	1.00 - 60.00	s	5.00	●

The energy saving rate (F05.16) indicates the energy saving capacity. The higher the set value is, the better the energy saving effect will be. If it is set as 0.00, the energy saving is disabled.

When the energy saving running is enabled, the energy saving conditions are reached and the energy saving actuation time (F05.17) is maintained, then the energy saving control will start.

No.	Function	Range	Unit	Default	Type
F05.18	Compensation Gain of Magnetic Flux of Synchronous Motor	0.00 - 500.00	%	100.00	●
F05.19	Filter Time Constant of	0.00 - 10.00	s	0.50	●

	Magnetic Flux Compensation of Synchronous Motor				
--	---	--	--	--	--

These are optimized parameters for VF control of the synchronous motor. Generally, user adopts the defaults

7.7 F06 Group: Vector Control Parameter

No.	Function	Range	Unit	Default	Type
F06.00	Speed Proportional Gain ASR_P1	0.00 - 100.00		12.00	●
F06.01	Speed Integral Time Constant ASR_T1	0.000 - 30.000 0.000: No Integral	s	0.200	●
F06.02	Speed Proportional Gain ASR_P2	0.00 - 100.00		8.00	●
F06.03	Speed Integral Time Constant ASR_T2	0.000 - 30.000 0.000: No Integral	s	0.300	●
F06.04	Switching Frequency 1	0.00 - Switching Frequency 2	Hz	5.00	●
F06.05	Switching Frequency 2	Switching Frequency 1 - Maximum Frequency F00.16	Hz	10.00	●

Under the vector control mode, inverter adjusts the speed dynamic response of the vector control by adjusting the PI regulator's speed proportional gain (ASR_P) and speed integral time (ASR_T). Either increasing ASR_P or reducing ASR_T would quicken the speed loop's dynamic response. However, if ASR_P is excessive or ASR_T is insufficient or excessive, this will result in oscillation due to over regulation.

User shall adjust the aforesaid PI parameters according to actual load characteristics. Generally, user shall increase ASR_P as possible and regulate ASR_T, so as to enable the system to response quickly without over control.

To enable the system to have a quick dynamic response at both low speed and high speed, it's required to perform PI regulation at both speed modes. In actual running, the speed regulator would automatically calculate present PI parameter according to present frequency. If present PI parameter is below the switching frequency 1, the speed PI parameter is P1, T1; if above the switching frequency 2, the speed parameter PI is P2, T2. If greater than the switching frequency 1(F06.04), but less than the switching frequency 2

(F06.05), the movement from switching frequency 1 to switching frequency 2 presents a linear transition procedure. See Figure 7-22 for details.

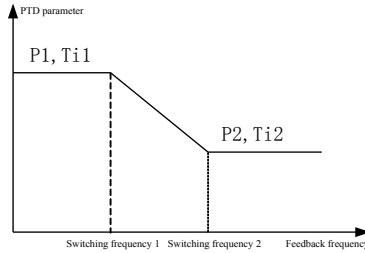

Figure 7-22 PI Parameter



1. Generally, user does not need to adjust F06.00 - F06.05 parameters, so please pay enough attention when you decide to adjust these parameters.
2. While setting the switching frequency, please note that the switching frequency 1 (F06.04) must be lower than or equivalent to the switching frequency 2 (F06.05).

No.	Function	Range	Unit	Default	Type
F06.06	Speed Loop Anti-Saturation Factor	0.000 - 1.000		0.500	●

When there is overshoot with the speed, properly increase this parameter, if there is no overshoot, try to reduce this parameter and keep the factory setting.

No.	Function	Range	Unit	Default	Type
F06.07	Time Constant of Output Filter of Speed Loop	0.000 - 0.100	s	0.001	●

The speed loop output filter can reduce the impacts upon current loop, but better not to set a large value for F06.07, which may cause slow response. Generally, user may use the defaults.

No.	Function	Range	Unit	Default	Type
F06.08	Vector Control Slip Gain	50.00 - 200.00	%	100.00	●

Motor speed goes down as load increases. To ensure that rotor speed gets close to synchronous rotation speed under motor rated load and slip compensation can be enabled. If motor speed goes below the target value, increase the value set through F06.08.

When inverter is in SVC control mode, this parameter is used to adjust the speed stability accuracy of motor: if the accuracy is relatively lower, increase the value set by the parameter and vice versa.

No.	Function	Range	Unit	Default	Type
F06.09	Speed control torque limit source selection	0: F06.10 and F06.11 1: AI1 2: AI2 3: AI3 4: AI4 (Expansion Card) 5: communication 6: maximum of AI2 and AI3 7: minimum of AI2 and AI3		0	○
F06.10	Upper Limit of Electric Torque for Speed Control	0.0 - 250.0	%	165.0	●
F06.11	Upper Limit of Brake Torque for Speed Control	0.0 - 250.0	%	165.0	●

This function code is used to set the action condition of the torque limit during vector control. If inverter output torque is higher than the torque limit, the torque limit function is enabled, so as to control the output torque to be not higher than the upper torque limit for speed control mode.

F06.09=0: the torque limit is set by F06.10 and F06.11

F06.09=1: the torque limit is set by AI1* F06.10 and F06.11

F06.09=2: the torque limit is set by AI2* F06.10 and F06.11

F06.09=3: the torque limit is set by AI3* F06.10 and F06.11

F06.09=4: the torque limit is set by AI4* F06.10 and F06.11

F06.09=5: the torque limit is set by communication

If it's master-slave communication (F10.05=1) and the inverter is slave (F10.06=0), the torque limit is “700FH (communication setting) * 250.0% * F10.08 (proportional coefficient)”. The range of 700FH is 0.00% to 100.00%. Details are shown on table 12-2.

If it's general communication (F10.05=0) the torque limit is “7019H (communication setting) * F06.10/ F06.11”. The range of 7019H is 0.00% to 250.0%. Details are shown on table 12-2.



1. This code indicates the ratio between the output torque at the torque limit and inverter rated output torque.
2. User can set the upper limit of the torque as per actual demands to protect motor or meet the operating mode requirements
3. The electric mode and the brake mode shall be set separately.

No.	Function	Range	Unit	Default	Type
F06.12	Excitation Current Proportional Gain ACR-P1	0.00 - 100.00		0.50	●
F06.13	Excitation Current Integral Time Constant ACR-T1	0.00 - 600.00 0.00: No Integral	ms	10.00	●
F06.14	Torque Current Proportional Gain ACR-P2	0.00 - 100.00		0.50	●
F06.15	Torque Current Integral Time Constant ACR-T2	0.00 - 600.00 0.00: No Integral	ms	10.00	●

Current loop PID regulator parameter can directly affect system performance and stability. On general conditions, user does not have to change the default value.

No.	Function	Range	Unit	Default	Type
F06.16	Position Loop Gain	0.000 - 40.000		1.000	●

The simple servo function is effective to synchronous motor control, gain adjustment can increase system rigidity.

No.	Function	Range	Unit	Default	Type
F06.17	SVC Zero Frequency Processing Method	0: Band-Type Brake 1: Not to Process 2: Pipe Sealing		2	○
F06.18	SVC Zero Frequency Band-Type Brake Current	50.0 - 400.0 (100.0=Idling Current)	%	100.0	○

When inverter is at the zero frequency running stage in FVC control mode (eg: F00.01=1), inverter acts as per the setting of F06.17.

If F06.17=0, inverter performs the band-type brake as per the set current of F06.18 to realize the zero servo function.

F06.17=1, Not to Process.

F06.17=2, Inverter will be blocked for output and coast to stop.

No.	Function	Range	Unit	Default	Type
F06.20	Voltage Feedforward Gain	0 - 100	%	0	●

When inverter is in the vector control, add the voltage feedforward gain to realize the automatic torque boost, i.e., stator voltage drop compensation.

Function Code	Name of Function Code	Parameter Description	Unit	Default	Default
F06.21	Field Weakening Control Options of Synchronous Motor	0: Disabled 1: Direct Calculation 2: Automatic Adjustment		1	○
F06.22	Field Weakening Factor of Synchronous Motor	100.00 - 200.00	%	100.00	●
F06.23	Maximum Field Weakening Current of Synchronous Motor	0.0 - 150.0 (100.0=Motor Rated Current)	%	50.0	●
F06.24	Proportional Gain of Field Weakening Regulator of Synchronous Motor	0.00 - 10.00		0.50	●
F06.25	Integral Time of Field Weakening Regulator of Synchronous Motor	0.00 - 6000.00	ms	100.00	●

Field weakening control of synchronous motor

F06.21=0: Disabled

If F06.21=0, the field weakening control will not work. At this time, the maximum value of motor rotation speed is related to bus voltage of inverter. When the maximum speed of motor can not meet the user requirements, user needs to start the field weakening function of synchronous motor for field weakening speed rise.

EM500 offers two field weakening modes: direct calculation mode and automatic adjustment mode

F06.21=1 Direct Calculation

In the direct calculation method, the required field weakening current is calculated as per the target rotation speed and its size can also be adjusted manually through 06.22. The lower the field weakening current is, the lower the total output current will be, but this may not achieve the required field weakening effect.

F06.21=2: Automatic Adjustment

In the automatic adjustment method, inverter will select the optimum field weakening current automatically, but this may affect the dynamic performance of the system or cause the system to be unstable.

Setting the proportional gain (F06.24) and the integral time (F06.25) can change the adjustment speed of the field weakening current, but the fast adjustment of the field weakening current may result in instability. Generally, user does not need to make manual modification.

No.	Function	Range	Unit	Default	Type
F06.27	Gain of Autotuning at Initial Position	0 - 600	%	80	●

User may adjust the autotuning effect by this parameter when inverter is in the initial position autotuning. The value of this parameter is usually got by autotuning and user does not need to set it manually. The higher the injection voltage is, the better the autotuning effect will be.

No.	Function	Range	Unit	Default	Type
F06.28	Frequency of Injection Current	0.00 - 100.00 (100.00= Motor Rated Frequency)	%	10.00	●

	at Low Frequency Range				
F06.29	Injection Current at Low Frequency Range	0.0 - 60.0 (100.0= Motor Rated Current)	%	20.0	●
F06.30	Low Frequency Range Regulator Gain of Injection Current	0.00 - 10.00		0.50	●
F06.31	Integral Time of Low Frequency Range Regulator of Injection Current	0.00 - 300.00	ms	10.00	●
F06.32	Frequency of Injection Current at High Frequency Range	0.00 - 100.00 (100.00= Motor Rated Frequency)	%	20.00	●
F06.33	Injection Current at High Frequency Range	0.0 - 30.0 (100.0= Motor Rated Current)	%	8.0	●
F06.34	High Frequency Range Regulator Gain of Injection Current	0.00 - 10.00		0.50	●
F06.35	Integral Time of High Frequency Range Regulator of Injection Current	0.00 - 300.00	ms	10.00	●

The high frequency current injection method realizes the detection of the initial position of the rotor. When inverter is in stationary status, inject the high frequency current to motor stator winding so as to estimate motor rotor position accurately by taking advantage of saliency effect and magnetic flux saturation characteristics and detecting the time of the high frequency current peak. According to the experimental result, this method does not have a high accuracy or depend upon any motor parameter.

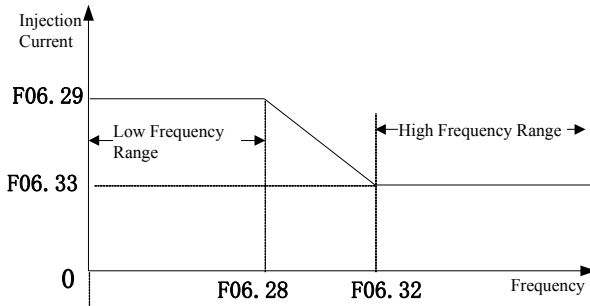

Figure 7-23 High Frequency Injection

At the low frequency range (output frequency < F06.28), the injection current is determined by F06.29; at the high frequency range (output frequency > F06.32), the injection current is determined through F06.33.

User may adjust the gain and the integral time with the regulator to achieve better effects. Generally, user may use the default value. Please do not adjust it if you are not a professional.

7.8 F07 Group: Fault Protection Parameter

No.	Function	Range							Unit	Default	Type
F07.00	Protection block	E20	E22	E13	SLU	SOU	SOC	ILP	ULP		000 00000
		0: Valid Protection 1: Protection blocked									

Bit setting value=0: After detecting the fault corresponding to the bit, inverter will stop output and enter the fault status.

Bit setting value=1: After detecting the fault corresponding to the bit, inverter will not enable the protection and remains the previous status.

This code is bit operation. Only corresponding bit has to be set as 0 or 1. See the table below:

Figure 7-8 Fault Protection blocking Bit

Protection Code	<i>E20</i>	<i>E22</i>	<i>E13</i>	<i>SLU</i>	<i>SOU</i>	<i>SOC</i>	<i>ILP</i>	<i>OLP</i>
Corresponding Bit	7	6	5	4	3	2	1	0
Set Value	0/1	0/1	0/1	0/1	0/1	0/1	0/1	0/1

For instance: for shielded *ILP* protection, only the first bit corresponding to *ILP* needs to be set as 1, i.e., F07.00=xxxxxx1x

For shielded *OLP* and *E13* protection, only the zero bit corresponding to *OLP* and the fifth bit corresponding to *E13* are set to 1, i.e., F07.00=xx1 xxxx1.



Please do not shield any protection function unless specially required.

Otherwise, inverter may be damaged due to no protection in case of a fault.

No.	Function	Range	Unit	Default	Type
F07.01	Motor Overload Protection Gain	0.20 - 10.00		1.00	●
F07.02	Motor Overload Pre-Alarming Factor	50 - 100	%	80	●

The inverse-time curve for motor overload protection: $200\% \times (F07.01) \times \text{Motor Rated Current}$, for 1 seconds continuously, an alarm is given for motor overload fault (E13); $150\% \times (F07.01) \times \text{Motor Rated Current}$, for 15 minutes continuously, an alarm is given for motor overload. User must set F07.01 according to motor's actual overload capacity. Excessive F07.01 value may easily pose a hazard of motor overheating without an alarm.

F07.02 pre-alarm factor is used to determine what degree prior to motor overload protection will trigger an alarm. The higher this factor is, the smaller the advance time of the pre-alarm will be.

If the accumulative output current of inverter is greater than the product of the overload inverse-time curve and F07.02, the multi-function numeric Do of inverter outputs "17: motor overload pre-alarm" ON signal.

No.	Function	Range	Unit	Default	Type
F07.03	Motor Temperature Sensor Type	0: No Temperature Sensor 1: PT100 2: PT1000 3: KTY84-130/150 4: PTC130/150		0	●

F07.04	Motor Overheating Protection Threshold	0 - 200	°C	110	●
F07.05	Motor Overheating Pre-Alarming Threshold	0 - 200	°C	90	●

To enable this protection, please confirm that present motor has a temperature sensor and transmits the temperature signal to the analog input terminal, and set the temperature sensor type (F07.03) to start motor overheating protection.

User may view present motor temperature through the function code F18.38; if motor temperature is greater than motor overheating alarm threshold (F07.05), the numeric output terminal “25: Motor Overload Pre-alarming” is enabled and this signal is used for instruction; if motor temperature is greater than motor overheating protection threshold (F07.04), inverter will give an alarm about motor overheating fault (E12) and start corresponding protection action.

★ Motor overheating fault (E12) can not be reset immediately until motor temperature drops to a value far below the protection threshold.

No.	Function	Range	Unit	Default	Type
F07.06	Bus Voltage Control Options	0: Disabled 1: Undervoltage Stall, Enabled 2: Overvoltage Stall, Enabled 3: Overvoltage Stall and Undervoltage Stall, Enabled		2	○
F07.07	Overvoltage Stall Control Voltage	110.0 - 150.0 (380V,100.0=537V)	%	131.0 (703V)	○
F07.08	Undervoltage Stall Control Voltage	60.0 - Judgment Voltage at Power Failure Ending (100.0= Standard Bus Voltage)		76.0	○

F07.06=0: Disabled

Overvoltage stall disabled; it's not recommended to set F07.06 as 0, if there is no external braking unit.

Undervoltage stall disabled;

F07.06=1: Undervoltage Stall, Enabled

When bus voltage is lower than the value set through F07.08, inverter stops after decelerating to zero, and gives an alarm for stable undervoltage fault (SIU).

F07.06=2: Overvoltage Stall, Enabled

If overvoltage stall is enabled, the stall voltage is set by F07.07.

DC bus overvoltage is generally caused by deceleration, because at the time of deceleration, DC bus voltage rises due to energy feedback. When DC bus voltage is higher than the overvoltage threshold:

If the overvoltage stall is enabled (F07.06=2/3) when the DC bus voltage is higher than the overvoltage threshold, inverter stops the deceleration and keeps output frequency unchanged; as a result, the energy feedback stops; until the DC bus voltage backs to normal, inverter starts deceleration again. During the deceleration, the overvoltage stall protection process is shown in Figure 7-24.

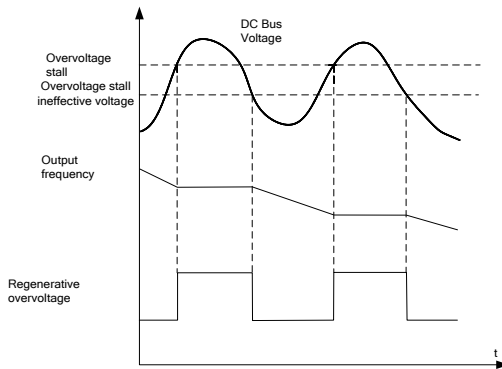

Figure 7-24 Overvoltage Stall Protection

F07.06=3: Overvoltage Stall and Undervoltage Stall, Enabled

Inverter is protected for both overvoltage stall and undervoltage stall.

No.	Function	Range	Unit	Default	Type
F07.09	Judgment Voltage at Power Failure Ending	Undervoltage Stall Control Voltage - 100.0	%	86.0	●
F07.10	Judgment Delay Time at Power Failure Ending	0.00 - 100.00	s	5.00	●

If bus voltage is lower than the value set through F07.08 (Undervoltage Stall Control Voltage), inverter will enter the power failure status. If bus voltage is greater than F07.09 (Judgment Voltage at Power Failure Ending), which lasts for the time set by F07.10 (Judgment Delay Time at Power Failure Ending), then inverter returns to the normal status

No.	Function	Range	Unit	Default	Type
F07.11	Current Limit Control	0: Disabled 1: Limit Mode 1 2: Limit Mode 2		3	○
F07.12	Current Limit Level	20.0 - 180.0 (100.0= Inverter Rated Current)	%	150.0	●

F07.11=0: Disabled

Current limit does not work

F07.11=1: Limit Mode 1

F07.11=2: Limit Mode 2

During operation, if output current reaches to current limit level F07.12 and current limit control is effective (F07.11=1), then the system will automatically start current limit: reducing output frequency to restrain the output current from going up, and inverter will quit from over current state. Inverter will return to previous running status, when output current reduces to a value below current limit action level. Current limit action procedure is shown in Figure 7-25.

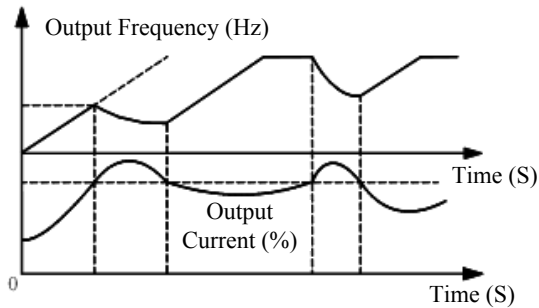

Figure 7-25 Current Limit Action Procedure

F07.12 is used to set the action conditions for enabling current limit. If inverter output current exceeds the set value of this function code, current limit function starts to act, so as to control output current at a level not greater than current limit.



Current limit only works for inverter under the V/F control mode. It's recommended to use this function for occasions of large inertia, fan type load, and the occasion “one inverter shared by multiple motors”.

No.	Function	Range	Unit	Default	Type
F07.13	Rapid Current Limit	0: Disabled 1: Enabled		0	○

F07.13=0: Disabled

The rapid current limit does not work.

F07.13=1: Enabled

The rapid current limit can reduce the overcurrent fault.

No.	Function	Range	Unit	Default	Type
F07.14	Fault Retry Times	0 – 20, 0: Fault Retry Disabled		0	○
F07.15	Numeric Output Action at Fault Retry	0: Disabled 1: Enabled		0	○
F07.16	Fault Retry Interval	0.01 - 30.00	s	0.50	●

F07.17	Recovery Time of Fault Retry Times	0.01 - 30.00						s	10.00	●
F07.18	Fault Retry	<i>ILP</i>	<i>HOU</i>	<i>HOC</i>	<i>SLU</i>	<i>SOU</i>	<i>SOC</i>		**0 00000	○
		0: Permitted 1: Not Permitted								

The fault retry function can be used to prevent the impact of an accident upon the normal system operation. It is only valid for some faults listed by F07.18.

When the fault retry function is enabled, a fault will cause inverter to start a fault retry, i.e., fault reset. Whether a fault status is outputted by the numeric output terminal shall be set through F07.15. If the fault is still detected subsequent to fault retry, continue with the fault retry until the set fault retry times (F07.14) are reached; if the fault is still detected after the fault retry times, an alarm will be given correspondingly; if the fault does not occur again in several following retries, the fault retry succeeds and inverter continues to work normally.

After the fault retry succeeds, the fault retry times will be cleared if no fault occurs in the recovery time of fault retry times (F07.17), and the fault retry still starts from 0 times when a fault occurs in the future; a fault retry time will be counted based upon the last fault retry count, if the fault still occurs in this retry.

No.	Function	Range							Unit	Default	Type	
F07.19	Action 1 at Fault	<i>E21</i>	<i>E16</i>	<i>E15</i>	<i>E14</i>	<i>E13</i>	<i>E12</i>	<i>OLP</i>	<i>ILP</i>	000 00000	○	
		0: Coast to Stop 1: Stop as per Set Stop Mode										
F07.20	Action 2 at Fault	<i>E28</i>	<i>E27</i>	<i>E25</i>	<i>E23</i>						*000	○
		0: Coast to Stop 1: Stop as per Set Stop Mode										

These function codes can be used to set inverter action mode when some faults occur. If any of them is set as 0, inverter coasts to stop; if any of them is set as 1, inverter stops as per the set stop mode (F04.19).

Such function codes are under the bit operation. Set corresponding position as 0 or 1 while setting them. See the table below:

Table 7-9 Action Bit at Fault

F07.19	<i>E21</i>	<i>E16</i>	<i>E15</i>	<i>E14</i>	<i>E13</i>	<i>E12</i>	<i>OLP</i>	<i>ILP</i>
F07.20	*	*	*	*	<i>E28</i>	<i>E27</i>	<i>E25</i>	<i>E23</i>

Corresponding Bit	7	6	5	4	3	2	1	0
Set Value	0/1	0/1	0/1	0/1	0/1	0/1	0/1	0/1

For example, user only needs to set the first bit of $\mathcal{U}LP$ and the third bit of $\mathcal{E}IB$ as 1, in order to set $\mathcal{U}LP$ and $\mathcal{E}IB$ as stop as per the set stop mode (F04.19) in case of a fault. I.e., F07.19=xxx x1x1x.

No.	Function	Range	Unit	Default	Type
F07.21	Offload Protection	0: Disabled 1: Enabled		0	●
F07.22	Offload Detection Level	0.0 - 100.0	%	20.0	●
F07.23	Load Detection Time	0.0 - 60.0	s	1.0	●
F07.24	Offload Protection	0: Coast to Stop 1: Stop as per Set Stop Mode		1	○

If output current is lower than the offload detection level (F07.22) and this status continues for the offload detection time (F07.23) when the offload detection protection is enabled (F07.21=1) and inverter is in the running mode and not in the DC brake, then inverter gives an offload protection fault (E26) report and stops as the offload protection setting (F07.24).

No.	Function	Range	Unit	Default	Type
F07.27	AVR	0: Disable 1: Enable 2: Automatic		1	○

F07.27=0: AVR is disabled.

F07.27=1: AVR is enabled.

AVR function has been effective, if the input voltage is lower than the rated input voltage, the voltage and the output frequency is greater than the VF curve corresponding to the frequency, frequency converter will output the maximum voltage in order to make the most of the motor power output; If the input voltage is higher than the rated input voltage, the frequency converter can reduce the output voltage, keep the VF proportion.

F07.27=2: AVR is automatic.

AVR function automatically effective (decelerating is invalid): the change of the frequency converter based on the actual power grid voltage, automatically adjust the

output voltage, and are keeping its rated output voltage

No.	Function	Range	Unit	Default	Type
F07.28	Stall fault detection time	0.0~6000.0	s	300.0	○
F07.29	The intensity of stall control	0~100	%	100	○

When the stall time is longer than set by F07.28, the drive reports a stall fault;

Stall state, the drive according to F07.29 set value for self-help control. Intensity is set according to Field application situation, is not the bigger the better.

7.9 F08 Group: Preset Speed and Simple PLC Parameter

No.	Function	Range	Unit	Default	Type
F08.00	Preset Speed 1	0.00 - Maximum Frequency F00.16	Hz	0.00	●
F08.01	Preset Speed 2	0.00 - Maximum Frequency F00.16	Hz	5.00	●
F08.02	Preset Speed 3	0.00 - Maximum Frequency F00.16	Hz	10.00	●
F08.03	Preset Speed 4	0.00 - Maximum Frequency F00.16	Hz	15.00	●
F08.04	Preset Speed 5	0.00 - Maximum Frequency F00.16	Hz	20.00	●
F08.05	Preset Speed 6	0.00 - Maximum Frequency F00.16	Hz	25.00	●
F08.06	Preset Speed 7	0.00 - Maximum Frequency F00.16	Hz	30.00	●
F08.07	Preset Speed 8	0.00 - Maximum Frequency F00.16	Hz	35.00	●
F08.08	Preset Speed 9	0.00 - Maximum Frequency F00.16	Hz	40.00	●
F08.09	Preset Speed 10	0.00 - Maximum Frequency F00.16	Hz	45.00	●
F08.10	Preset Speed 11	0.00 - Maximum Frequency F00.16	Hz	50.00	●
F08.11	Preset Speed 12	0.00 - Maximum Frequency F00.16	Hz	50.00	●
F08.12	Preset Speed 13	0.00 - Maximum Frequency F00.16	Hz	50.00	●
F08.13	Preset Speed 14	0.00 - Maximum Frequency F00.16	Hz	50.00	●
F08.14	Preset Speed 15	0.00 - Maximum Frequency F00.16	Hz	50.00	●

16 preset speeds through the control terminal of multiple preset speeds and 15 preset frequency commands, as well as numeric frequency setting F00.07

Table 7-10 Preset Speed Commands and Preset Speed Terminals

Preset speed	Preset speed terminal 4	Preset speed terminal 3	Preset speed terminal 2	Preset speed terminal 1	Selected frequency	Corresponding function code
1	Disabled	Disabled	Disabled	Disabled	Numeric Frequency	Determined by

EM500 Open-Loop Vector Control Inverter User Manual

					Setting	F00.07
2	Disabled	Disabled	Disabled	Enabled	Preset Speed 1	F08.00
3	Disabled	Disabled	Enabled	Disabled	Preset Speed 2	F08.01
4	Disabled	Disabled	Enabled	Enabled	Preset Speed 3	F08.02
5	Disabled	Enabled	Disabled	Disabled	Preset Speed 4	F08.03
6	Disabled	Enabled	Disabled	Enabled	Preset Speed 5	F08.04
7	Disabled	Enabled	Enabled	Disabled	Preset Speed 6	F08.05
8	Disabled	Enabled	Enabled	Enabled	Preset Speed 7	F08.06
9	Enabled	Disabled	Disabled	Disabled	Preset Speed 8	F08.07
10	Enabled	Disabled	Disabled	Enabled	Preset Speed 9	F08.08
11	Enabled	Disabled	Enabled	Disabled	Preset Speed 10	F08.09
12	Enabled	Disabled	Enabled	Enabled	Preset Speed 11	F08.10
13	Enabled	Enabled	Disabled	Disabled	Preset Speed 12	F08.11
14	Enabled	Enabled	Disabled	Enabled	Preset Speed 13	F08.12
15	Enabled	Enabled	Enabled	Disabled	Preset Speed 14	F08.13
16	Enabled	Enabled	Enabled	Enabled	Preset Speed 15	F08.14

Attentions:

- ★ At preset speed running, inverter start/stop is determined by the function code F00.02.
- ★ At preset speed running mode, inverter acceleration/deceleration time can be controlled by the external terminal set as the acceleration/deceleration time.

Direction at preset speed running is controlled by terminals F/R and RUN.

No.	Function	Range	Unit	Default	Type
F08.15	Simple PLC Running Mode	0: Stop after Single Running 1: Stop after Limited Times of Cycles 2. Run at Last Preset Speed after Limited Times of Cycles 3: Continuous Cycle		0	●
F08.16	Limited Times of Cycles	1 - 10000		1	●

In addition to preset speed function, there is simple PLC function, which provides four control modes. See Table 7-11 for details.

Table 7-11 PLC Running Mode

F08.15	Description
0	Inverter stops after running at the last preset speed.
1	Run circularly; the cycle times is set through F08.16; inverter stops after the cycles are complete.
2	Run circularly; the number of cycle times is set through F08.16; after having completed the running at the last preset speed, inverter keeps running at the last preset speed until a stop command is received.
3	Run continuously and circularly until a stop command is received.

★ Inverter starts the judgment from the running time of the 15th preset speed (F08.48) to the first preset speed. A function code not set as 0 is the last preset speed.

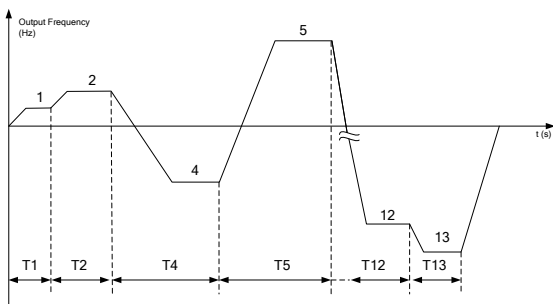

Figure 7-26 Simple PLC Running

As illustrated in Figure 7-26, it is the running mode after setting “0: Stop after Single Running”. Since preset speed 3 is set as 0 (F08.24=0.0), inverter will not run at preset speed 3 actually. Since preset speed 14 and preset speed 15 are set as 0 (F08.46=0.0 and F08.48=0.0), preset speed 13 is the last one and inverter will stop after running at preset speed 13.

No.	Function	Range	Unit	Default	Type
F08.17	Simple PLC Memory	Ones Place: Stop Memory 0: Disabled (Start from Preset Speed 1) 1: Enabled (Start at Power Failure) Tens Place: Power Failure Memory 0: Disabled (Start from Preset Speed 1) 1: Enabled (Start at Power Failure)		00	●

PLC stop memory function enables inverter to record the running times (F18.10), running stage (F18.11) and present running time (F18.12) of present simple PLC at stop.

Inverter continues with the memorized stage for the running of the next time. If the simple PLC memory function is disabled, the PLC process will be started for every time after inverter restart.

PLC power failure memory function enables inverter to record the running times (F18.10), running stage (F18.11) and present running time (F18.12) of present simple PLC before the power failure. Inverter continues with the memorized stage at the next energization. If the PLC power failure memory function is disabled, the PLC process will be started for every time after inverter restart.

No.	Function	Range	Unit	Default	Type
F08.18	Simple PLC Time Unit	0: s (second) 1: min (minute)		0	•

To meet different working conditions, the setting for the running time of PLC can be in figures only. Specific meanings shall be set together with the simple PLC time unit (F08.18). There are two time units available.

No.	Function	Range	Unit	Default	Type
F08.19	Setting of Preset Speed 1	Ones Place: Running Direction 0: Forward 1: Reverse Tens Place: Acceleration/Deceleration Time 0: Acceleration/Deceleration Time 1 1: Acceleration/Deceleration Time 2 2: Acceleration/Deceleration Time 3 3: Acceleration/Deceleration Time 4		0	•
F08.20	Running Time of Preset Speed 1	0.0 - 6000.0		5.0	•
F08.21	Setting of Preset Speed 2	Ones Place: Running Direction 0: Forward 1: Reverse Tens Place: Acceleration/Deceleration Time 0: Acceleration/Deceleration Time 1 1: Acceleration/Deceleration Time 2 2: Acceleration/Deceleration Time 3		0	•

EM500 Open-Loop Vector Control Inverter User Manual

		3: Acceleration/Deceleration Time 4		
F08.22	Running Time of Preset Speed 2	0.0 - 6000.0	5.0	•
F08.23	Running Time of Preset Speed 3	<p>Ones Place: Running Direction 0: Forward 1: Reverse</p> <p>Tens Place: Acceleration/Deceleration Time 0: Acceleration/Deceleration Time 1 1: Acceleration/Deceleration Time 2 2: Acceleration/Deceleration Time 3 3: Acceleration/Deceleration Time 4</p>	0	•
F08.24	Running Time of Preset Speed 3	0.0 - 6000.0	5.0	•
F08.25	Setting of Preset Speed 4	<p>Ones Place: Running Direction 0: Forward 1: Reverse</p> <p>Tens Place: Acceleration/Deceleration Time 0: Acceleration/Deceleration Time 1 1: Acceleration/Deceleration Time 2 2: Acceleration/Deceleration Time 3 3: Acceleration/Deceleration Time 4</p>	0	•
F08.26	Running Time of Preset Speed 4	0.0 - 6000.0	5.0	•
F08.27	Setting of Preset Speed 5	<p>Ones Place: Running Direction 0: Forward 1: Reverse</p> <p>Tens Place: Acceleration/Deceleration Time 0: Acceleration/Deceleration Time 1 1: Acceleration/Deceleration Time 2 2: Acceleration/Deceleration Time 3 3: Acceleration/Deceleration Time 4</p>	0	•
F08.28	Running Time of Preset Speed 5	0.0 - 6000.0	5.0	•
F08.29	Setting of Preset Speed 6	<p>Ones Place: Running Direction 0: Forward 1: Reverse</p> <p>Tens Place:</p>	0	•

EM500 Open-Loop Vector Control Inverter User Manual

		Acceleration/Deceleration Time 0: Acceleration/Deceleration Time 1 1: Acceleration/Deceleration Time 2 2: Acceleration/Deceleration Time 3 3: Acceleration/Deceleration Time 4			
F08.30	Setting of Preset Speed 7	0.0 - 6000.0		5.0	●
F08.31	Running Time of Preset Speed 7	Ones Place: Running Direction 0: Forward 1: Reverse Tens Place: Acceleration/Deceleration Time 0: Acceleration/Deceleration Time 1 1: Acceleration/Deceleration Time 2 2: Acceleration/Deceleration Time 3 3: Acceleration/Deceleration Time 4		0	●
F08.32	Running Time of Preset Speed 7	0.0 - 6000.0		5.0	●
F08.33	Setting of Preset Speed 8	Ones Place: Running Direction 0: Forward 1: Reverse Tens Place: Acceleration/Deceleration Time 0: Acceleration/Deceleration Time 1 1: Acceleration/Deceleration Time 2 2: Acceleration/Deceleration Time 3 3: Acceleration/Deceleration Time 4		0	●
F08.34	Running Time of Preset Speed 8	0.0 - 6000.0		5.0	●
F08.35	Setting of Preset Speed 9	Ones Place: Running Direction 0: Forward 1: Reverse Tens Place: Acceleration/Deceleration Time 0: Acceleration/Deceleration Time 1 1: Acceleration/Deceleration Time 2 2: Acceleration/Deceleration Time 3 3: Acceleration/Deceleration Time 4		0	●
F08.36	Running Time of Preset Speed 9	0.0 - 6000.0		5.0	●

F08.37	Setting of Preset Speed 10	Ones Place: Running Direction 0: Forward 1: Reverse Tens Place: Acceleration/Deceleration Time 0: Acceleration/Deceleration Time 1 1: Acceleration/Deceleration Time 2 2: Acceleration/Deceleration Time 3 3: Acceleration/Deceleration Time 4	0	•
F08.38	Running Time of Preset Speed 10	0.0 - 6000.0	5.0	•
F08.39	Setting of Preset Speed 11	Ones Place: Running Direction 0: Forward 1: Reverse Tens Place: Acceleration/Deceleration Time 0: Acceleration/Deceleration Time 1 1: Acceleration/Deceleration Time 2 2: Acceleration/Deceleration Time 3 3: Acceleration/Deceleration Time 4	0	•
F08.40	Running Time of Preset Speed 11	0.0 - 6000.0	5.0	•
F08.41	Setting of Preset Speed 12	Ones Place: Running Direction 0: Forward 1: Reverse Tens Place: Acceleration/Deceleration Time 0: Acceleration/Deceleration Time 1 1: Acceleration/Deceleration Time 2 2: Acceleration/Deceleration Time 3 3: Acceleration/Deceleration Time 4	0	•
F08.42	Running Time of Preset Speed 12	0.0 - 6000.0	5.0	•
F08.43	Setting of Preset Speed 13	Ones Place: Running Direction 0: Forward 1: Reverse Tens Place: Acceleration/Deceleration Time 0: Acceleration/Deceleration Time 1 1: Acceleration/Deceleration Time 2	0	•

		2: Acceleration/Deceleration Time 3 3: Acceleration/Deceleration Time 4			
F08.44	Running Time of Preset Speed 13	0.0 - 6000.0		5.0	●
F08.45	Setting of Preset Speed 14	Ones Place: Running Direction 0: Forward 1: Reverse Tens Place: Acceleration/Deceleration Time 0: Acceleration/Deceleration Time 1 1: Acceleration/Deceleration Time 2 2: Acceleration/Deceleration Time 3 3: Acceleration/Deceleration Time 4		0	●
F08.46	Running Time of Preset Speed 14	0.0 - 6000.0		5.0	●
F08.47	Setting of Preset Speed 15	Ones Place: Running Direction 0: Forward 1: Reverse Tens Place: Acceleration/Deceleration Time 0: Acceleration/Deceleration Time 1 1: Acceleration/Deceleration Time 2 2: Acceleration/Deceleration Time 3 3: Acceleration/Deceleration Time 4		0	●
F08.48	Running Time of Preset Speed 15	0.0 - 6000.0		5.0	●

In simple PLC running, user can set running frequency, running direction, acceleration/deceleration time and overall running time for preset speed 1 - 15, respectively. Let's take preset speed 13 (last one) as an example; its specific running conditions are shown in Figure 7-26.

F08.12=50.00: The running frequency for preset speed 13 is 50.00 Hz;

F08.43=31: At preset speed 13, inverter runs reversely and acceleration/deceleration is controlled by acceleration/deceleration time 4 (F15.07/F15.08);

F08.44=5.0: Running Time of Preset Speed 13 is 5.0s (default setting: F08.18=0).

7.10 F09 Group: PID Function Parameter

EM500 inverter has a process PID function, which is to be described in this part.

The process PID function is mainly used for pressure control, flow control and temperature control.

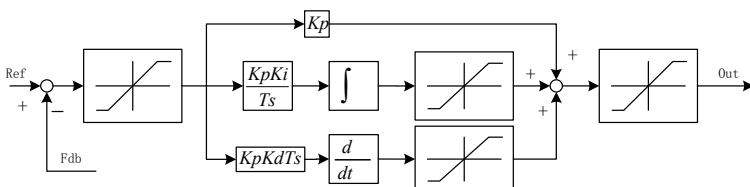

Figure 7-27 Process PID Block Diagram

PID control is a closed loop control mode. The output signal (Out) of the controlled object of the system is fed back to PID controller, which adjusts the output of the controller through PID arithmetic and forms a closed loop or multiple closed loops. By using PID control, the output value and the set target value of the controlled object are consistent. See Figure 7-27 for the functional block diagram.

PID controller implements the control by calculating the three calculation factors, i.e., P (proportional), I (integral) and D (differential) and on the basis of the dispersion between target (Ref) and feedback signal. The features of various calculation factors are as follows:

P (proportion):

Proportional control is the easiest control mode. Output error signal and input error signal of its control are proportional. The system outputs the stable error when inverter is in the proportional control only.

I (integral):

The integrals of output error signal and input error signal of the controller are directly proportional. This control mode can eliminate the stable error and enable the system to be free from stable error after entering the stable status. However, under this mode, inverter can not track intense changes.

D (Differential):

The differential values of output error signal and input error signal of the controller are directly proportional. Its controller can predicate the trend of error changes and respond to intense changes to improve the dynamic characteristics of the system in the regulation process.

No.	Function	Range	Unit	Default	Type
F09.00	PID Setting Source	0: Numeric PID Setting 1: All		0	○

		2: AI2 3: AI3 4: AI4 (Expansion Card) 5: PULSE High-Frequency Pulse (X7) 6: Communication Percentage Setting			
F09.01	Numeric PID Setting	0.0 – PID Setting Feedback Range F09.03		0.0	●
F09.03	PID Setting Feedback Range	0.1 - 6000.0		100.0	●

F09.00=0: Numeric PID Setting

PID setting is done by numeric PID setting, with the specific percentage of F09.01/F09.03 * 100.00%.

F09.00=1: AI1

F09.00=2: AI2

F09.00=3: AI3

F09.00=4: AI4 (Expansion Card)

The specific percentage of PID setting is directly determined by AI (percentage).

F09.00=5: PULSE High-Frequency Pulse (X7)

The specific percentage of PID setting is directly determined by HDI (percentage).

Please refer to the description of F00.04 for detailed explanations of AI1-AI4 and X7. When they are used for PID setting, their percentages are set values, with the maximum output of 100.00%.

F09.00=6: Communication Percentage Setting

The specific percentage of PID setting is directly determined by communication (percentage).

- If inverter is under master-slave communication control (F10.05=1) and present inverter is a slave (F10.06=0), the set percentage is “700FH (Master-Slave Communication Setting) * F10.08 (Receiving Proportionality Factor of Slave)”. The range of 700FH is -100.00% to 100.00%. See Table 12-2 for details.
- For general communication (F10.05=0), the feedback percentage is “7005 H (Communication Setting of Process PID Feedback)”. The range of 7005 H is -100.00% to 100.00%. See Table 12-2 for details.

No.	Function	Range	Unit	Default	Type
F09.02	PID Feedback Source	1: AI1 2: AI2 3: AI3 4: AI4 (Expansion Card) 5: High-Frequency Pulse (X7) 6: Communication Percentage Setting		1	○

F09.02=1: AI1

F09.02=2: AI2

F09.02=3: AI3

F09.02=4: AI4 (Expansion Card)

The specific percentage of PID feedback is directly determined by AI (percentage).

F09.02=5: High-Frequency Pulse (X7)

The specific percentage of PID feedback is directly determined by HDI (percentage)

Please refer to the description of F00.04 for detailed explanations of AI1-AI4 and X7. When they are used for PID setting, their percentages are set values, with the maximum output of 100.00%.

F09.02=6: Communication Percentage Setting

The specific percentage of PID feedback is directly determined by communication (percentage).

- If inverter is under master-slave communication control (F10.05=1) and present inverter is a slave (F10.06=0), the feedback percentage is “700FH (Master-Slave Communication Setting) * F10.08 (Receiving Proportionality Factor of Slave)”. The range of 700FH is -100.00% to 100.00%. See Table 12-2 for details.
- For general communication (F10.05=0), the feedback percentage is “7005 H (Communication Setting of Process PID Feedback)”. The range of 7005 H is -100.00% to 100.00%. See Table 12-2 for details.

No.	Function	Range	Unit	Default	Type
F09.04	PID Positive/Negative Action	0: Positive Action 1: Negative Action		0	○

The action mode of the process PID is determined through the setting of F09.04 and

the status of the input function “PID Positive/Negative Action Switch” together. See Table 7-12 for their relationship details

Table 7-12 PID Positive/Negative Action

F09.04	44: PID Positive/Negative Action Switch	Action mode	Description
0	0	Positive Action	Positive offset and output
0	1	Negative Action	Positive offset, but negative output
1	0	Negative Action	Positive offset, but negative output
1	1	Positive Action	Positive offset and output

Note: The offset is usually “Setting - Feedback” in PID control.

- When feedback signal is greater than PID setting, inverter’s output frequency is required to decrease to make PID reach to a balance. When pressure is higher, the pressure feedback is greater. In this case, inverter’s output frequency falls to reduce the pressure and make it constant. PID should be set as positive effect.
- When feedback signal is greater than PID setting, it’s required to increase inverter output frequency to balance PID. An example is given about supply control: PID regulator shall be in the negative action control

No.	Function	Range	Unit	Default	Type
F09.05	Proportional Gain 1	0.00 - 100.00		0.40	●
F09.06	Integral Time 1	0.000 - 30.000, 0.000: No Integral	s	10.000	●
F09.07	Differential Time 1	0.000 - 30.000	ms	0.000	●
F09.08	Proportional Gain 2	0.00 - 100.00		0.40	●
F09.09	Integral Time 2	0.000 - 30.000, 0.000: No Integral	s	10.000	●
F09.10	Differential Time 2	0.000 - 30.000	ms	0.000	●
F09.11	PID Parameter Switching	0: Disabled 1: Switching through Numeric Input Terminal 2: Automatic Switching by Offset		0	●
F09.12	PID Parameter Switching Offset 1	0.00 - F09.13	%	20.00	●
F09.13	PID Parameter Switching Offset 2	F09.12 - 100.00	%	80.00	●

To meet different complicated applications, the process PID module has introduced two groups of PID parameters. Parameters can be switched between these two groups through the function setting of F09.11 and the input conditions (input function “43: PID Parameter Switching”, offset $e(k)$, etc.) and performed for linear interpolation. See Table 7-13 for details

Table 7-13 PID Parameter Options

Mode		Description
F09.11	Other Conditions	
0	--	Not Switching of PID Parameter, the first group of parameters work
1	43: PID Parameter Switch	PID parameter is switched by the numeric input terminal (43: PID Parameter Switch)
	0	Invalid switching, the first group of parameters work
	1	Invalid switching, the second group of parameters work
2	$ e(k) - F09.12/13$	Automatic Switching by Offset
	$ e(k) < F09.12$	The first group of parameters
	$ e(k) > F09.13$	The first group of parameters
	Intermediate Value	Two groups of parameters are taken as the reference for linear interpolation according to the offset

As listed in the table above, when the function code F09.11 is set as 0, PID parameters will not be switched and the first group of parameters works; when the function code is set as 1, PID parameters will be switched according to the input function “43: PID Parameter Switching”; when the function code is set as 2, PID parameters will be selected or operated by linear interpolation according to the relationship between the absolute value of present offset $e(k)$ ($=|\text{Setting} - \text{Feedback}|$) and the function codes F09.12 and F09.13.

When $F09.12 \leq |e(k)| \leq F09.13$, present PID parameter is obtained through the linear interpolation of parameters of the first group and the second group. See 7-28 median section for specific principles.

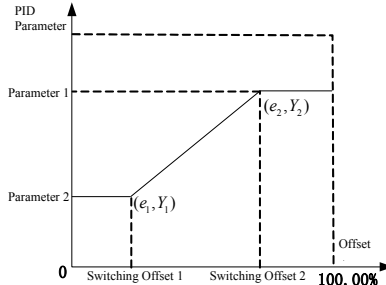

Figure 7-28 PID Automatic Switching of PID Parameters by Offset (F19.11=2)

No.	Function	Range	Unit	Default	Type
F09.14	PID Initial Value	0.00 - 100.00	%	0.00	●
F09.15	PID Initial Value Retention Time	0.00 - 650.00	s	0.00	●

The process PID module outputs PID initial value (F09.14) constantly for PID initial value retention time after inverter starts to run; afterwards, inverter proceeds with PID output regulation. See Figure 7-29 for specific effects.

When PID initial value is held for 0.00s, i.e., F09.15=0.00, the output function of PID initial value is disabled.

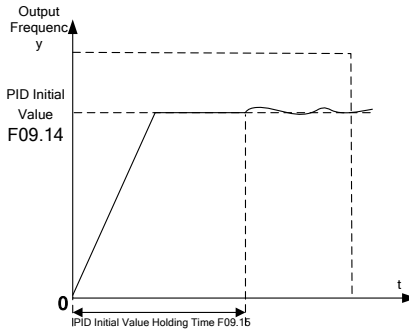



Figure 7-29 PID Initial Value Output

No.	Function	Range	Unit	Default	Type
F09.16	Upper Limit of PID Output	F09.17 ~ +100.0	%	100.0	●
F09.17	Lower Limit of PID Output	-100.0 - F09.16	%	0.0	●

For PID output limit, the output range of the whole process PID module is F09.17 - F09.16, the actual regulation results are in this scope, with the output at the boundary.

No.	Function	Range	Unit	Default	Type
F09.18	PID Offset Limit	0.00 - 100.00, (disabled at 0.00)	%	0.00	●

When the offset between PID setting and feedback is less than and equal to the offset limit (F09.18), PID stops the regulation. In this way, when the offset between the setting and the feedback is low, output frequency stabilizes, which works for some closed loop control occasions.

 When the input terminal function “41: Process PIC Pause” is enabled, PID can also stop the regulation. User may use these two methods together.

No.	Function	Range	Unit	Default	Type
F09.19	PID Differential Limit	0.00 - 100.00	%	5.00	●

The differential (D) component of PID regulator can not be greater than PID differential limit value (F09.19) to avoid excessively high offset, otherwise the output is also greater and causes the system oscillation. Properly setting this value can affect the impact of the occasional interference upon the system.

Function Code	Name of Function Code	Parameter Description	Unit	Default	Property
F09.20	PID Integral Separation Threshold	0.00 - 100.00, (100.00%=Integral Separation Disabled)	%	100.00	●

To perform PID regulation in a faster and better way, it's not required to conduct the integral regulation temporarily sometimes, but only PD or P regulation. EM500 inverter has a particular integral separation function: When the offset between PID setting and feedback is greater than PID integral separation threshold (F09.20), the integral separation is enabled, i.e., the integral (I) regulation function of PID regulator pauses. The input terminal function “42: Process PID Integral Pause” can be used together for

remote control. If the function code setting is disabled (F09.20=100.00), the input terminal function does not work. See Table 7-14 for details

Table 7-14 Integral Separation Function Description

Mode		Description
F09.20	DI (42)	F09.20: PID Integral Separation Threshold; DI (42): Process PID Integral Pause
100.00%	--	The integral (I) is always enabled
0.00%		Up to the relationship between $ e(k) $ and F09.20, and the status of DI
-	Disabled	If $ e(k) > F09.20$, the integral separation will be enabled
99.99%	Enabled	Integral Separation Enabled

No.	Function	Range	Unit	Default	Type
F09.21	PID Setting Variation Time	0.000 - 30.000	s	0.000	●

PID setting variation time refers to the time required for the change from 0.0% to 100.0%. It is similar to an acceleration/deceleration function. If PID setting changes, the actual setting value of PID will have a linear change to reduce the impact incurred upon the system. After the initial value is set, the smooth setting will be invalid.

Function Code	Name of Function Code	Parameter Description	Unit	Default	Property
F09.22	PID Feedback Filter Time	0.000 - 30.000	s	0.000	●
F09.23	PID Output Filter Time	0.000 - 30.000	s	0.000	●

F09.22 is used for filtering of PID feedback. The filtering action is in favour of reducing the interference impact upon the feedback, but causes the response performance of the closed loop system of the process to go down.

F09.23 is used to filter PID output. The filter can reduce the possibility of sudden change of inverter output frequency, but this can also reduce the response performance of process closed loop system.

No.	Function	Range	Unit	Default	Type
F09.24	Upper Limit Detection	0.00 - 100.00	%	100.00	●

	Value of PID Feedback Disconnection	100.00=Feedback Disconnection Disabled			
F09.25	Lower Limit Detection Value of PID Feedback Disconnection	0.00 - 100.00 0.00=Feedback Disconnection Disabled	%	0.00	●
F09.26	PID Feedback Disconnection Detection Time	0.000 - 30.000	s	0.000	●

PID feedback disconnection detection function can be used to prevent a slip accident due to the feedback disconnection. The setting depends upon the nature of the feedback sensor.

If 0.01% sensor is fed back at disconnection, it's required to set F09.25 as a proper value. When the feedback is less than the value set through F09.25 and this status is maintained for PID Feedback Disconnection Detection Time (F09.26), it is deemed as a PID feedback disconnection. If 100.0% sensor is fed back at disconnection, it's required to set F09.24 as a proper value. When the feedback is greater than the value set through F09.24 and this status is maintained for PID Feedback Disconnection Detection Time (F09.26), it is deemed as a PID feedback disconnection.

★ Once the feedback sensor is determined, only corresponding detection mode is enabled, either upper limit detection or lower limit detection, other than both.

No.	Function	Range	Unit	Default	Type
F09.27	PID Sleep Control	0: Disable 1: Enable 2: Lower Limit Frequency Enable 3: No Output Enable		0	●
F09.28	Sleep Action Point	0.00 - 100.00 (100.00 corresponds to PID Setting Feedback Range)	%	100.00	●
F09.29	Sleep Delay Time	0.0 - 6500.0	s	0.0	●
F09.30	Awakening Action Point	0.00 - 100.00 (100.00 corresponds to PID Setting Feedback Range)	%	0.00	●
F09.31	Awakening Delay Time	0.0 - 6500.0	s	0.0	●

At a moment in some occasions, when both the output and the feedback stabilize or the controlled is in the permitted range, the output is not permitted at this time and inverter may enter into a transient sleep status; when the controlled exceeds the permitted range, inverter is awakened and starts the output again; in this way, these function codes not only control the controlled within the permitted and saves the energy. See Table 7-15 for detailed function description.

Table 7-15 Sleep Awakening Function

Mode		Description
Action Mode	Status	
Positive Action (For example, Constant Voltage Control)	Normal Operation	Judge the sleep condition: If the absolute value of the feedback $>$ the sleep action point (F09.28) Or the output frequency reaches the lower limit and cannot continue to decelerate for it is limited by inverter lower limit frequency or PID output lower limit frequency, when the above conditions are met and maintained for the sleep delay time (F09.29), inverter enters into the sleep mode. ★ During the delay, PID continues the output; After the delay, function code sets output.
	Sleep Mode	Judge the awakening condition: If the absolute value of the feedback \geq the awakening action point (F09.28) and this status is maintained for the awakening delay time (F09.31), inverter exits the sleep mode. ★ During the delay, function code sets output; after the delay, PID continues with the normal output
Negative Action (For example, Constant Temperature Control)	Normal Operation	Judge the sleep condition: If the absolute value of the feedback $<$ the sleep action point (F09.28) Or the output frequency reaches the lower limit and cannot continue to decelerate for it is limited by inverter lower limit frequency or PID output lower limit frequency, when the above conditions are met and maintained for the sleep delay time (F09.29), inverter enters into the sleep mode. ★ During the delay, PID continues the output; After the delay, function code sets output.
	Sleep Mode	Judge the awakening condition: If the absolute value of the feedback \geq the awakening action

		point (F09.28) and this status is maintained for the awakening delay time (F09.31), inverter exits the sleep mode ★ During the delay, function code sets output; after the delay, PID continues with the normal output
--	--	---

Recommendation: During the positive action, F09.28 (awakening action point) \geq F09.30 (awakening action point); during negative action, F09.28 (awakening action point) \leq F09.30 (awakening action point).

No.	Function	Range	Unit	Default	Type
F09.32	Preset PID Setting 1	0.0 – PID Setting Feedback Range F09.03		0.0	●
F09.33	Preset PID Setting 2	0.0 – PID Setting Feedback Range F09.03		0.0	●
F09.34	Preset PID Setting 3	0.0 – PID Setting Feedback Range F09.03		0.0	●

These function codes are used for PID setting together with the function code.

EM500 inverter has the preset PID setting function, for which the switching condition is mainly determined by the input function “15: Preset PID Terminal 1” and “16: Preset PID Terminal 2”. See Table 7-16 for details.

Mode			Setting	Range	Setting
16	15	F09.00			
Disabled	Disabled	0	F09.01	0.0 - F09.03	0.00% - 100.00%
		1	AI1	-100.00% - 100.00%	-100.00% - 100.00%
		2	AI2	-100.00% - 100.00%	-100.00% - 100.00%
		3	AI3	-100.00% - 100.00%	-100.00% - 100.00%
		4	AI4	-100.00% - 100.00%	-100.00% - 100.00%
		5	HDI	-100.00% - 100.00%	-100.00% - 100.00%
		6	485	-100.00% - 100.00%	-100.00% - 100.00%
Disabled	Enabled	--	F09.32	0.0 - F09.03	0.00% - 100.00%
Enabled	Disabled	--	F09.33	0.0 - F09.03	0.00% - 100.00%
Enabled	Enabled	--	F09.34	0.0 - F09.03	0.00% - 100.00%

Table 7-16 Preset PID Setting Function

No.	Function	Range	Unit	Default	Type
F09.35	The Feedback Voltage Upper Limit	The feedback voltage lower limit~10.00	V	10.00	●
F09.36	The Feedback Voltage Lower Limit	0.00~ The Feedback Voltage Upper Limit	V	0.00	●

The feedback voltage upper and lower limits can be used for automatic Material supply disruptions detection of the winding application, which represent the upper and lower bounds of the Material supply disruptions, respectively. Due to the particularity of the winding application, F09.35 and F09.36 can be Used to reflect the real sensor boundaries, which is more conducive to system stability.

No.	Function	Range	Unit	Default	Type
F09.37	PID Integral Action Choice Given Change Time	0: Always calculated integral item 1: F09.21 began calculating integral item When set time has arrived 2: when the error is less than F09.38 Start calculating integral item		0	●
F09.38	PID Integral Action Given Change Ttime Input Deviation	0.00-100.00	%	30.00	●

F09.37=0: Always calculated integral item

This function code does not affect the integral effect

F09.37=1 F09.21 began calculating integral item When set time has arrived

The first F09.21 changes within the time set after starting does not work

F09.37=2 when the error is less than F09.38 Start calculating integral item

The first F09.21 changes within the time set after starting does not work, however, if the error is less than F09.38 in this time, the Integral re-effect

7.11 F10 Group: Communication Function Parameter

EM500 inverter supports Modbus protocol of RTU format, and the with single-master and multi-slave communication network with RS485 bus (see Chapter 12).

No.	Function	Range	Unit	Default	Type
F10.00	Inverter Address	1 - 247, 0 as broadcasting address		1	○

As a slave when connected to the whole communication network, inverter must have a unique address, for which the setting scope is 1 to 247. That is to say, 247 inverters are supported by one network.

★ 0 is a broadcasting address, which can be recognized by all inverters and does not need to be set specifically.

All masters and slaves connected to the same network must follow the same transmission principles (for example bit rate, data format and protocol format) to ensure the normal communication. Therefore, the settings for F10.01 (bit rate), F10.02 (data format) and F10.10 (communication protocol; default: Modbus-RTU protocol for EM500) for all devices connected to the network are the same.

No.	Function	Range	Unit	Default	Type
F10.01	Modbus Communication Bit Rate	0: 4800 1: 9600 2: 19200 3: 38400 4: 57600 5: 115200	bps	1	○

EM500 Inverter supports 6 bit rates (unit: bit/s) when it is in Modbus-RTU communication. If F10.01=9600 bps, it means that 9600 bits will be transmitted for each second. Under default conditions, to transmit each byte of valid data (for example 0x01), the actual transmission is 10 bits and the time needed is about 1.04 ms (about $1.04167 \text{ ms} = 10 \text{ bit} / 9600 \text{ bps}$).

No.	Function	Range	Unit	Default	Type
F10.02	Modbus Data Format	0: 1-8-N-1 (1 start bit + 8 data bits + 1 stop bit) 1: 1-8-E-1 (1 start bit + 8 data bits + 1 even parity + 1 stop bit) 2: 1-8-O-1 (1 start bit + 8 data bits + 1 odd parity + 1 stop bit) 3: 1-8-N-2 (1 start bit + 8 data bits + 2 stop bits)		0	○

		4: 1-8-E-2 (1 start bit + 8 data bits + 1 even parity +2 stop bits) 5: 1-8-O-2 (1 start bit + 8 data bits + 1 odd parity +2 stop bit)			
--	--	--	--	--	--

When transmitting data via Modbus protocol of RTU format, inverter supports 6 different data formats according to data combinations. When transmitting data via Modbus protocol of RTU format, inverter supports 6 different data formats according to data combinations.

Start bit	Valid data								Parity	Stop bit
1	7	6	5	4	3	2	1	0	N/O/E	1

If F10.02=0, it means that present data format is 1 start bit + 8 data bits + no parity +1 stop bit

★ N (NONE), no parity; E (EVEN), even parity; O (ODD), odd parity.

Inverter also supports the functions of communication overtime and response delay, when it is networked for communication with Modbus protocol, in order to meet various requirements.

No.	Function	Range	Unit	Default	Type
F10.03	Modbus Overtime	0.0 - 60.0, 0.0: Disabled (also works for master - slave system)	s	0.0	●

As shown in Figure 7-30, the communication interval Δt refers to the period from the previous receipt of a valid data frame by slave (inverter) to the receipt of a valid data frame again. If Δt is greater than the set time (see F10.03; this function is disabled if it is set as 0), this is called “communication overtime”.

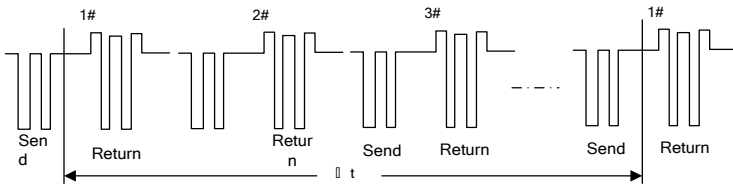

Figure 7-30 Communication Overtime

Application example: If master must send data to a slave (for example #1) within a certain time T, then user may enable the communication overtime function for #1 slave

by setting F10.03>T. No fault report for the communication overtime will be triggered during normal communication. However, if master does not send data to #1 slave for a time period T and this condition is maintained for a time set by F10.03, then a communication abnormality fault (E16) will be reported to notify the personnel of “#1 slave communication fault”, so that the personnel may conduct troubleshooting.

★ The time set by F10.03 must be greater than T, but must not be excessive, otherwise the running of inverter under a fault condition for a long time may result in adverse effects.

★F10.03 should be disable normally. Only in the continuous communication system, set up the parameters, used to monitor the communication status.

Function Code	Name of Function Code	Parameter Description	Unit	Default	Property
F10.04	Modbus Response Delay	1 - 20	ms	2	●

Define the time interval from the receipt of valid data frame 1 by inverter, to data learning, and then to starting the data return, as the response delay (t_{w2}). To ensure that the protocol chip works stably, the response delay shall be set as 1 ms to 20 ms (no 0). If the communication data involves EEPROM, the actual response delay will be extended to “EEPROM action time + F10.04”

l: valid data frame: sent by the external master to inverter, and the function code, data length and CRC are correct.

As shown in Figure 7-31, data sending section (t_s), sending end mark section (t_{w1}), 75176 forwarding waiting section (t_{w2}), data return section (t_r) and 75176 receipt section (t_{w3}).

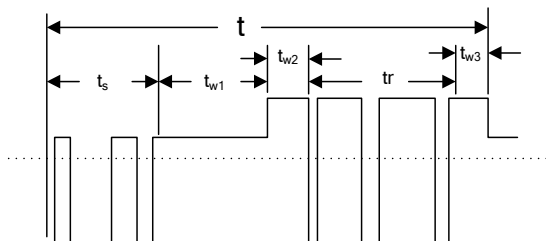

Figure 7-31 Complete Data Frame Time Sequence Translation

No.	Function	Range	Unit	Default	Type
F10.05	Master-Slave Communication Function	0: Disabled 1: Enabled		0	○
F10.06	Master-Slave Options	0: Slave 1: Master (Modbus protocol) 2: Master (CANSinee protocol)		0	○
F10.07	Data Sent by Master	0: Output Frequency 1: Set Frequency 2: Output Torque 3: Set Torque 4: PID Setting 5: Output Current		1	○
F10.08	Receiving Proportionality Factor of Slave	0.00 - 10.00 (Times)		1.00	●
F10.09	Sending Interval of Master	0.000 - 30.000	s	0.200	●

EM500 supports master-slave communication function. In master-slave communication, one inverter is used as master while other inverters are slaves; all slaves work as the command sent by master to achieve the synchronous running function of multiple inverters.

- For master, inverter will be set as follows:
 - Set F10.05=1 to enable master-slave function;
 - Set F10.06=1 or 2 to set present inverter as master (only one inverter can be used as

master in a network);

F10.07 is used to set the variable needing synchronization; for example output current, set F10.07=5.

- For a slave, inverter will be set as follows:

Set F10.05=1 to enable master-slave function

Set F10.06=0 to select present inverter as a slave;

Set a setting as communication setting; for example, if F09.00=6, and the process PID is set individually (F00.05=10 and F00.06=1), slave inverter will take output current of master as the setting for PID regulation.

For a slave, F10.08 can be used to determine how inverter makes use of the received data.If F10.08=0.80, the finally used data is “Recv (Received Data) * 0.80 (F10.08)”.

For master, F10.09 can be used to determine how long a command is sent by master.

No.	Function	Range	Unit	Default	Type
F10.10	Communication Protocol	0: Modbus-RTU Protocol 1: Profibus-DP Protocol 2: CANopen Protocol 3: DeviceNet Protocol		0	○

EM500 inverter supports multiple communication protocols. Except inverter for Modbus-RTU, user must buy an expansion card of the company independently. Please contact your dealer if necessary.

No.	Function	Range	Unit	Default	Type
F10.11	Communication Address of Profibus-DP Expansion Card	1 - 125		1	○
F10.12	Communication Address of CANopen Expansion Card	1 - 127		1	○
F10.13	Communication Address of DeviceNet Expansion Card	0 - 63		1	○

For communication expansion card address setting, user only needs to set

No.	Function	Range	Unit	Default	Type
F10.14	Response Delay Time of Process Data of Communication Card	0.0 - 200.0	ms	0.0	○

corresponding function codes to current expansion card.

This function code is used to determine the delay response time of communication card after master sends data to communication card.

No.	Function	Range	Unit	Default	Type
F10.15	Bit Rate of Communication between Expansion Card and Bus	Ones Place: CANopen 0: 125K 1: 250K 2: 500K 3: 1M Tens Place: DeviceNet 0: 125K 1: 250K 2: 500K		23	○

When selecting a communication expansion card, CANopen or DeviceNet, user needs to set the bit rates for the communication between the expansion card and the bus.

No.	Function	Range	Unit	Default	Type
F10.16	PROFIBUS Communication Format	0: PPO1 1: PPO2 2: PPO3 3: PPO4 4: PPO5			×

When the selected expansion card is Profibus-DP, user needs to set the communication format. Please refer to the expansion card manual for details

No.	Function	Range	Unit	Default	Type
F10.17	Received Data Type PZD2	When the displayed data is 65535, it means that present PZD is not used. When the displayed data is other data, for example 4609, it means that the function parameter is F18.01 (18D=12H, 01D=01H, 1201H=4609D)		65535	○
F10.18	Received Data Type PZD3			65535	○
F10.19	Received Data Type PZD4			65535	○
F10.20	Received Data Type PZD5			65535	○
F10.21	Received Data Type PZD6			65535	○
F10.22	Received Data Type PZD7			65535	○
F10.23	Received Data Type PZD8			65535	○
F10.24	Received Data Type PZD9			65535	○
F10.25	Received Data Type PZD10			65535	○
F10.26	Received Data Type		65535	○	

	PZD11		
F10.27	Received Data Type PZD12	65535	○
F10.28	Received Data Type PZD13	65535	○
F10.29	Received Data Type PZD14	65535	○
F10.30	Received Data Type PZD15	65535	○
F10.31	Received Data Type PZD16	65535	○
F10.32	Sent Data Type PZD2	65535	○
F10.33	Sent Data Type PZD3	65535	○
F10.34	Sent Data Type PZD4	65535	○
F10.35	Sent Data Type PZD5	65535	○
F10.36	Sent Data Type PZD6	65535	○
F10.37	Sent Data Type PZD7	65535	○
F10.38	Sent Data Type PZD8	65535	○
F10.39	Sent Data Type PZD9	65535	○
F10.40	Sent Data Type PZD10	65535	○
F10.41	Sent Data Type PZD11	65535	○
F10.42	Sent Data Type PZD12	65535	○
F10.43	Sent Data Type PZD13	65535	○
F10.44	Sent Data Type PZD14	65535	○
F10.45	Sent Data Type PZD15	65535	○
F10.46	Sent Data Type PZD16	65535	○

F10.17 - F10.31 are used to define the data sent from the communication expansion card (i.e., received by inverter) and are generally parameter setting; F10.32 - F10.46 are used to define the data received by the communication expansion card (sent by inverter) and are generally status parameters. All the exchange data should correspond to these functions codes or the defined fields of the virtual addresses and not be manually set. Refer to communication expansion card instructions. All the exchange data correspond to the function codes or the virtual address definition areas respectively (refer to Communication Protocol) and user does not need to set them manually. Refer to corresponding manuals of communication expansion cards.

No.	Function	Range	Unit	Default	Type
F10.47	Communication Card Status	Ones Place: Profibus-DP 0: Initialization Status 1: Wait for Parameterization Status 2: Wait for Configuration Status 3: Data Exchange Status 4: Modbus Communication Abnormality Status 5: Factory Test Status Tens Place: CANopen 0: Initialization Status 1: Pre-Operation Status 2: Operation Status 3: Stop Status 4: CANopen Communication Abnormality Status 5: Modbus Communication Abnormality Status 6: Factory Test Status Hundreds Place: DeviceNet 0: Initialization Status 1: MACID Detection Status 2: Online Non-Connection Status 3: Connection Status 4: IO Communication Overtime Status 5: DeviceNet Bus Communication Abnormality Status 6: Modbus Communication Abnormality Status 7: Factory Test Status		000	×

Communication card only read the parameters. Refer to corresponding manuals of communication expansion cards.

No.	Function	Range	Unit	Default	Type
F10.48	Communication Card Software Version				×

A read only parameter of communication card.

No.	Function	Range	Unit	Default	Type
F10.49	number of process data received	1~16		2	●
F10.50	number of process data transmission	1~16		2	●
F10.51	Process data address setting mode selection	0: keypad 1: Master		0	●
F10.52	Communication card manual reset selection	0: disable 1: enable		0	●

Communication card function, as shown in the communication card manual.

EM500 inverter support CANSinee communication protocol based on CAN, which realize the communication between PC or PLC with inverter or more communication between the inverters.

No.	Function	Range	Unit	Default	Type
F10.53	CANSinee Communication address	1~31		1	○

When the Inverter as a slave into the bus, must have its own unique address. The setting range is 1 ~ 31, that is, the whole network supports up to 31 slaves.

★ 0 is the broadcast address, all the inverters can be identified from the machine, this address does not need to set.

No.	Function	Range	Unit	Default	Type
F10.54	CANSinee Communication baud rate	0: 125K 1: 250K 2: 500K 3: 1M		0	○

EM500 series inverter supports 4 different baud rates. With the upper computer or multi-machine communication, the inverter / host computer needs to be set to the same baud rate. The baud rate will affect the communication distance See Chapter 13 for more information.



No.	Function	Range	Unit	Default	Type
F10.55	CANSine Communication timeout	0.0 - 60.0, 0.0: Disabled (also works for master - slave system)	s	0.0	●

CANSine protocol communication, Communication timeout setting, See the Modbus Communication Timeout function explanation

No.	Function	Range	Unit	Default	Type
F10.56	RS485write EEPROM	0~10: default for debugging 11: No trigger write before debugging		0	○

For the PLC or HMI with inverter after equipment debugging is completed, set F10.56 = 11, then all write data isn't stored; PLC communication can avoid writing EEPROM. If parameters should be saved after power off please setting F10.56 = 0.

7.12 F11 Group: User-Defined Parameter

First, by setting F11, user may select a function code and enter the user-defined mode (--U--, see 4.2.2). Through  and , user may switch to the desired function code circularly. This function is mainly applied to occasions of less than 32 function codes so as to avoid troubles of too many function codes.

No.	Function	Range	Unit	Default	Type
F11.00	User-Defined Parameter 1	The content displays Uxx.xx, which means that Fxx.xx function code is selected. If the keypad displays U00.00 at the time of entering the function code F11.00, it means that the first user-defined parameter is F00.00.		U00.00	●
F11.01	User-Defined Parameter 2			U00.01	●
F11.02	User-Defined Parameter 3			U00.02	●
F11.03	User-Defined Parameter 4			U00.03	●
F11.04	User-Defined Parameter 5			U00.04	●
F11.05	User-Defined Parameter 6			U00.07	●
F11.06	User-Defined Parameter 7			U00.14	●
F11.07	User-Defined Parameter 8			U00.15	●

F11.08	User-Defined Parameter 9		U00.16	●
F11.09	User-Defined Parameter 10		U00.18	●
F11.10	User-Defined Parameter 11		U00.19	●
F11.11	User-Defined Parameter 12		U00.29	●
F11.12	User-Defined Parameter 13		U02.00	●
F11.13	User-Defined Parameter 14		U02.01	●
F11.14	User-Defined Parameter 15		U02.02	●
F11.15	User-Defined Parameter 16		U03.00	●
F11.16	User-Defined Parameter 17		U03.02	●
F11.17	User-Defined Parameter 18		U03.21	●
F11.18	User-Defined Parameter 19		U04.00	●
F11.19	User-Defined Parameter 20		U04.20	●
F11.20	User-Defined Parameter 21		U05.00	●
F11.21	User-Defined Parameter 22		U05.03	●
F11.22	User-Defined Parameter 23		U05.04	●
F11.23	User-Defined Parameter 24		U08.00	●
F11.24	User-Defined Parameter 25		U19.00	●
F11.25	User-Defined Parameter 26		U19.01	●
F11.26	User-Defined Parameter 27		U19.02	●
F11.27	User-Defined Parameter 28		U19.03	●

F11.28	User-Defined Parameter 29		U19.04	●
F11.29	User-Defined Parameter 30		U19.05	●
F11.30	User-Defined Parameter 31		U19.06	●
F11.31	User-Defined Parameter 32		U19.12	●



F11.00=U00.00, means that the first user-defined parameter is the function code F00.00. The switching sequence of the function codes under the user-defined mode set by the keypad shall be the sequence set by the function codes F11.00 - F11.31.

7.13 F12 Group: Keypad and Display Parameter

No.	Function	Range	Unit	Default	Type
F12.00	M.K	0: No Function 1: Forward JOG 2: Reverse JOG 3: Forward/Reverse Switch 4: Rapid Stop 5: Coast to Stop 6: Cursor Left Shift		1	○

 is a multifunction key. By setting the function code F12.00, its actual function will be realized. If F12.00=0, this function does not work; if F12.00=Any other value, press this key to realize corresponding function.

No.	Function	Range	Unit	Default	Type
F12.01	STOP	0: Valid Only at Keypad Control 1: Valid at All Command Channels		1	○

According to the setting of the function code F00.02 (command source options), the command source has three control types, keypad control, terminal control and communication control, i.e., if the terminal control is selected as the command source, the buttons  and  of keypad will be disabled. However, in emergency, user

often uses  of keypad to stop inverter for purpose of eliminating risks, which is the fastest way. However, during the normal running of inverter, it is the most convenient way to stop inverter through the keypad. Therefore, the function code F12.01 is added and the default setting is that the STOP button is always enabled.

★ It's not recommended to modify this function code. If necessary, please pay enough attention.

No.	Function	Range	Unit	Default	Type
F12.02	Parameter Locking	0: Unlocked 1: Reference Input, Unlocked 2: All Locked Except this Function Code		0	●

In order to avoid unnecessary risks caused by misoperation or non-personnel operation of keypad, the keypad has the parameter locking function. If the default setting of this function code is “unlocked”, you can set all function codes; after all the function codes are debugged according to the working conditions, user may lock parameters.

- 1: Reference Input, Unlocked

Under the parameter locking mode, no function code can be modified except the function codes with the reference input and this function code. Specific function codes with the inference input are indicated in Table 7-17:

Table 7-17 Function Codes with Reference Input

No.	Function	No.	Function
F00.07	Numeric Frequency Setting	F08.11	Preset Speed 12
F08.00	Preset Speed 1	F08.12	Preset Speed 13
F08.01	Preset Speed 2	F08.13	Preset Speed 14
F08.02	Preset Speed 3	F08.14	Preset Speed 15
F08.03	Preset Speed 4	F13.02	Numeric Torque Setting
F08.04	Preset Speed 5	F09.01	Numeric PID Setting
F08.05	Preset Speed 6	F09.32	Preset PID Setting 1
F08.06	Preset Speed 7	F09.33	Preset PID Setting 2

F08.07	Preset Speed 8	F09.34	Preset PID Setting 3
F08.08	Preset Speed 9	F13.03	Preset Torque 1
F08.09	Preset Speed 10	F13.04	Preset Torque 2
F08.10	Preset Speed 11	F13.05	Preset Torque 3

- 2: All Locked Except this Function Code

Under the parameter locking mode, no function code can be set except this function code. This mode is mostly applied to the working conditions that the parameters have been set and debugged and no parameter setting is required. Under this mode, user only run, stop and monitor inverter.

No.	Function	Range	Unit	Default	Type
F12.03	Parameter Copy	0: No Autotuning 1: Upload Parameter to Keypad 2: Download Parameter to Inverter		0	○

As for a working condition that multiple inverters shall run under the same parameter settings, user may debug one inverter; set F12.03=1 for it, and upload the set parameters to the keypad for temporary saving; then set F12.03=2 for the rest inverters, and now download the parameter settings to them. By using this function, user may set parameters of multiple inverters quickly. User may set most function codes at first even if there are still individual parameters with different settings, and user may complete the setting of such individual parameter settings by other methods. (See 4.5 Parameter Copy)

No.	Function	Range	Unit	Default	Type
F12.04	LED Display Parameter 1	00000000 - 11111111 (o for non-displaying, 1 for displaying) bit0: Output Frequency bit1: Set Frequency bit2: Output Current bit3: Output Voltage bit4: DC Bus Voltage bit5: Output Power bit6: Output Torque bit7: Torque Setting		000 11111	●
F12.05	LED Display	00000000 - 11111111 (o for		000	●

	Parameter 2	non-displaying, 1 for displaying) bit0: Not Used bit1: Estimated Feedback Frequency bit2: Load Speed bit3: Numeric Input Terminal Status 1 bit4: Numeric Input Terminal Status 2 bit5: Numeric Input Terminal Status 3 bit6: Numeric Output Terminal Status 2 bit7: All		00000	
F12.06	LED Display Parameter 3	00000000 - 11111111 (o for non-displaying, 1 for displaying) bit0: AI2 bit1: AI3 bit2: AI4 bit3: PID Input bit4: PID Feedback bit5: Count Value bit6: Actual Length bit7: High-Frequency Pulse Input Frequency: kHz		000 00000	•
F12.07	LED Display Parameter 4	00000000 - 11111111 (o for non-displaying, 1 for displaying) bit0: High-Frequency Pulse Input Frequency: Hz bit1: kilowatt-hour meter: MWh bit2: kilowatt-hour meter: kWh bit3: Remaining Time of Timed Run bit4: Simple PLC Running Times bit5: Simple PLC Running Stage bit6: PLC Running Time of Present Stage bit7: Not Used		000 00000	•
F12.08	LED Display Parameter 5	00000000 - 00001111 (o for non-displaying, 1 for displaying) bit0: UP/DOWN Offset		*0000	•

		bit1: VF Separation Output Voltage bit2: VF Separation Target Voltage bit3: Motor Temperature bit4 - bit7: Not Used			
--	--	--	--	--	--

User may press ESC to enable inverter to enter the monitoring mode (see 4.4 Operation Monitoring); now, press  to switch among parameters circularly. Function codes F12.04 - F12.05 are used to select which parameters are to be displayed, i.e., the parameters are in a circular display queue. The selected options correspond to the F18 Group: Monitoring Parameter, so user may enter F18 to view present values of all parameters. This function is mainly for fast display, especially during the running period.

Under default conditions, the circular display queue only displays some commonly used options, respectively output frequency (F18.00), set frequency (F18.01), output current (F18.06), output voltage (F18.08) and DC bus voltage (F18.09). If other parameters are required for display, please set these parameters as 1; if not, set them as 0.

★ Please pay enough attention when retaining some function codes

No.	Function	Range	Unit	Default	Type
F12.09	Load Speed Display Factor	0.01 - 600.00		30.00	●

Inverter output is mostly displayed in frequency. To get to know present load speed (F18.13), user may set present parameter according to actual working conditions, so as to convert the frequency output into the speed output; as a result, F18.13 would be used to display present load speed.

If F12.09=30.00 (this value is relative to pole-pairs, device transmission ratio, etc.), then output frequency 0.00 - 50.00 Hz corresponds to the load speed 0 - 1500 rpm.

No.	Function	Range	Unit	Default	Type
F12.10	UP/DOWN Acceleration/Deceleration Rate	0.00: Automatic Rate 0.01 - 500.00	Hz/s	5.00	○
F12.11	UP/DOWN Offset Clear	0: Not to Clear 1: Clear at Non-Running Status 2: Clear at Disabled UP/DOWN		1	○

F12.12	Power Failure Save of UP/DOWN Offset	0: Disabled 1: Enabled (only at modified offset)		0	○
--------	--------------------------------------	---	--	---	---

The function UP/DOWN can be classified into the keypad UP/DOWN and the terminal UP/DOWN, which can be enabled individually and simultaneously

- Keypad UP/DOWN: Only enabled at the level 0 monitoring menu, which is under control of clockwise rotation of digital potentiometer and counter clockwise rotation of digital potentiometer on the keypad.

Under the monitoring menu clockwise or counter clockwise rotation of digital potentiometer the offset frequency increases/decreases at the rate set through F12.10; at this time, the keypad displays “F18.01: Set Frequency” and the final frequency is the sum of the set frequency and the offset frequency. After releasing the button for 2s, the keypad displays normally.

- Terminal UP/DOWN: By setting the numeric input terminal as corresponding function, inverter is under terminal control.

When the terminal UP/DOWN is on, the offset frequency increases/decreases at the rate set through F12.10 and the final frequency is the sum of the set frequency and the offset frequency.

★ When the keypad UP and the terminal down (or the keypad DOWN and the terminal UP) are enabled at the same time, the offset frequency fluctuates due to different valid time points, although the acceleration/deceleration speed does not change. It is a normal phenomenon.

No.	Function	Range	Unit	Default	Type
F12.13	Kilowatt-Hour Meter Clear	0: Not to Clear 1: Clear		0	●

EM500 inverter has a kilowatt-hour meter function (refer to the descriptions of F18.18 and F18.19). User may set present function code as 1 to clear present count

No.	Function	Range	Unit	Default	Type
F12.14	Reset	0: No Autotuning 1: Reset (exclusive of motor parameter, inverter parameter,		0	○

		manufacturer parameter, running and power-on time record)			
--	--	---	--	--	--

By setting this parameter as 1, user may reset all parameters except motor parameter (F01 group), inverter parameter, manufacturer parameter, power-on time (F12.15/16) and running time (F12.17 and F12.18)

★ This operation is irreversible. Please pay enough attention while operating.

No.	Function	Range	Unit	Default	Type
F12.15	Accumulated Power-On Time h	0 - 65535	h	0	×
F12.16	Accumulated Power-On Time mi	0 - 59	min	0	×

F12.15 and F12.16 are used together to view the accumulated power-on time from the production of inverter until now (as per the time that inverter is powered on). This value will be accurate to 1 minute, and up to about 65,536 hours (about 7.5 years).

If F12.15=50 and F12.16=33, it means that the accumulated power-on time of inverter is 2 days 2 hours and 33 minutes.

★ These parameters are used for viewing only and can not be operated or cleared

No.	Function	Range	Unit	Default	Type
F12.17	Accumulated Running Time h	0 - 65535	h	0	×
F12.18	Accumulated Running Time (min)	0 - 59	min	0	×

F12.17 and F12.18 are used together to view the accumulated power-on time from the production of inverter until now (as per the time that inverter runs). This value will be accurate to 1 minute, and up to about 65,536 hours (about 7.5 years).

If F12.17=47 and F12.18=39, it means that inverter has run for 1 day and 23 hours and 39 minutes.

★ These parameters are used for viewing only and can not be operated or cleared

No.	Function	Range	Unit	Default	Type
F12.19	Inverter Rated Power	0.40 - 650.00	kW	Up To Specific Model	×
F12.20	Inverter Rated Voltage	60 - 690	V	Up To Specific Model	×
F12.21	Inverter Rated Current	0.1 - 1500.0	A	Up To Specific Model	×

These function codes are used to view the rated power, rated voltage and rated current of inverter.

★ These parameters are used for viewing only and can not be operated.

No.	Function	Range	Unit	Default	Type
F12.22	Performance Software Serial Number1	XXX.XX		XXX.XX	×
F12.23	Performance Software Serial Number2	XX.XXX		XX.XXX	×
F12.24	Function Software Serial Number 1	XXX.XX		XXX.XX	×
F12.25	Function Software Serial Number 2	XX.XXX		XX.XXX	×
F12.26	Keypad Software Serial Number 1	XXX.XX		XXX.XX	×
F12.27	Keypad Software Serial Number 2	XX.XXX		XX.XXX	×

These function codes are used to view the software version of inverter

★ These parameters are used for viewing only and can not be operated.

No.	Function	Range	Unit	Default	Type
F12.28	Product Serial Number 1	XX.XXX		XX.XXX	×
F12.29	Product Serial Number 2	XXXX.X		XXXX.X	×
F12.30	Product Serial Number 3	XXXXX		XXXXX	×

These function codes are used to view the type of present product

★ These parameters are used for viewing only and cannot be operated.

No.	Function	Range	Unit	Default	Type
F12.31	LCD Language	0: Chinese 1: English 2: Not Used		0	●

LCD keyboard language selection.

No.	Function	Range	Unit	Default	Type
F12.32	Monitor mode	0: Mode 0 1: Mode 1		1	●
F12.33	Mode 1 display parameter 1 (LED Stop status display parameter 5)	0.00~99.99		18.00	●
F12.34	Mode 1 display parameter 2 (LED Stop status display parameter 1)	0.00~99.99		18.01	●
F12.35	Mode 1 display parameter 3 (LED Stop status display parameter 2)	0.00~99.99		18.06	●
F12.36	Mode 1 display parameter 4 (LED Stop status display parameter 3)	0.00~99.99		18.08	●
F12.37	Mode 1 display parameter 5 (LED Stop status display parameter 4)	0.00~99.99		18.09	●

F12.32=0, Monitor mode 0. LED switching display and LCD small line (7 lines)

Display function code is determined by F12.04 ~ F12.08 settings, The selected function code is described in the parameter description.

F12.32=1, Monitor mode 1. LED switching display and LCD small line (7 lines)
 Display function code is determined by F12.33 ~ F12.37 settings, Function code can be selected arbitrarily. F12.33 = 18.00, it means to select display F18.00 function code.

No.	Function	Range	Unit	Default	Type
F12.38	LCD display parameter 1	0.00~99.99		18.00	●
F12.39	LCD display parameter 2	0.00~99.99		18.06	●
F12.40	LCD display parameter 3	0.00~99.99		18.09	●

LCD large display function code selection,F12.38=18.00, It shows the first line display the F18.00 function code. LCD large display mode is the default value, a screen can monitor F18.00, F18.06 and F18.09 three function codes.

★ LCD keyboard small row and large row display switch as shown below

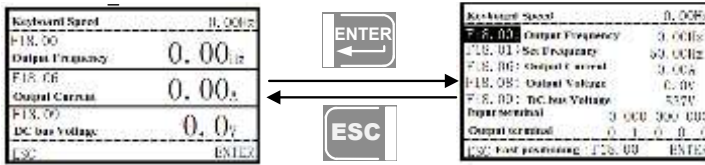

LCD Keypad Refer to the LCD Keypad User's Manual for operation.

Refer to Section 4 of Chapter 4 for the monitor mode selection.

No.	Function	Range	Unit	Default	Type
F12.41	UP/DOWN cross zero option	0: forbidden 1: allowed		0	○

The UP / DOWN function is enabled, When F12.41 = 0, the UP / DOWN function will not reverse when the inverter output frequency reduce to 0, When F12.41 = 1, the UP / DOWN function will reverse running when the inverter output frequency reduce to 0.

No.	Function	Range	Unit	Default	Type
F12.42	Digital potentiometer	0.00~F00.16	Hz	0.00	×

	frequency reference				
F12.43	Digital potentiometer torque reference	0.00~ F13.02	%	0.0	×

The way of digital potentiometer given refers to main frequency source A given.

7.14 F13 Group: Torque Control Parameter

No.	Function	Range	Unit	Default	Type
F13.00	Speed/Torque Control	0: Speed Control 1: Torque Control		0	○

F13.00=0: Speed Control

The control mode is the speed input type, with the frequency as the input.

F13.00=1: Torque Control

Input control mode is torque input and input is the percentage of motor rated torque current; only under SVC control mode, i.e., F00.01=1 can it be enabled.

The final control mode is also related to “29: Torque Control Disabled” and “28: Switch between Speed Control and Torque Control”. See corresponding description.

Table 7-18 Final Control Mode of Inverter

29: Torque Control Disabled	28: Switch between Speed Control and Torque Control	F13.00	Final Control Mode
Enabled	*	*	Speed Control
Disabled	Enabled	0	Torque Control
		1	Speed Control
	Disabled	0	Speed Control
		1	Torque Control

No.	Function	Range	Unit	Default	Type
F13.01	Torque Setting	0: Numeric Torque Setting F13.02 1: AI1 2: AI2		0	○

		3: AI3 4: AI4 (Expansion Card) 5: High-Frequency Pulse Input (X7) 6: Communication Percentage Setting (Full ranges of options 1 to 6, correspond to numeric torque setting F13.02) 7: Not Used 8: digital potentiometer			
F13.02	Numeric Torque Setting	-200.0 - 200.0 (100.0= Motor Rated Torque)	%	100.0	●

F13.01=0: Numeric Torque Setting F13.02

The torque is set through F13.02.

F13.01=1: AI1**F13.01=2: AI2****F13.01=3: AI3****F13.01=4: AI4 (Expansion Card)**

The torque is controlled by AI (percentage) * F13.02.

F13.01=5: High-Frequency Pulse Input (X7)

The torque is controlled by HDI (percentage) * F13.02.

Please refer to the description of F00.04 for detailed explanations of AI1-AI4 and X7. F00.04 has the same meanings as AI1-AI4 and X7. 100.00% is the percentage inputted through F13.02 (Numeric Torque Setting).

F13.01=6: Communication Percentage Setting

The torque is determined by communication, etc

- If inverter is under master-slave communication control (F10.05=1) and present inverter is a slave (F10.06=0), the set percentage is “700FH (Master-Slave Communication Setting) * F10.08 (Receiving Proportionality Factor of Slave)”. The range of 700FH is -100.00% to 100.00%. See Table 12-2 for details.
- For general communication (F10.05=0), the set percentage is “7003H (Torque Communication Setting) * F00.18 (Numeric Torque Setting)”. The range of 7003H is -200.00% to 200.00%. See Table 12-2 for details

F13.01=8: Digital Potentiometer Setting

Torque mode, the torque given directly by the digital potentiometer, the specific value can see F12.43

No.	Function	Range	Unit	Default	Type
F13.03	Preset Torque 1	-200.0 - 200.0	%	0.0	●
F13.04	Preset Torque 12	-200.0 - 200.0	%	0.0	●
F13.05	Preset Torque 13	-200.0 - 200.0	%	0.0	●

To realize the diversification of the torque application, EM500 inverter supports the preset torque function. Set the input terminal “17: Preset Torque Terminal 1” and “18: Preset Torque Terminal 2”. See Table 7-19 for details

Table 7-19 Preset Torque Commands and Preset Torque Terminals

18: Preset Torque Terminal 2	17: Preset Torque Terminal 1	Torque	Torque
Disabled	Disabled	Preset Torque 1	Set through F13.01
Disabled	Enabled	Preset Torque 1	F13.03
Enabled	Disabled	Preset Torque 1	F13.04
Enabled	Enabled	Preset Torque 1	F13.05

No.	Function	Range	Unit	Default	Type
F13.06	Torque Control Acceleration/Deceleration Time	0.00 - 120.00	s	0.05	●

Setting F13.06 can make the motor speed change smoothly

The value set by F13.06 refers to the time that the torque current increases from 0 to the rated torque current or decreases from the rated current to 0.

No.	Function	Range	Unit	Default	Type
F13.08	Upper Limit Frequency of Torque Control	0: Set through F13.09 1: AI1 2: AI2 3: AI3 4: AI4 (Expansion Card)		0	○

		5: High-Frequency Pulse Input (X7) 6: Communication Percentage Setting 7: Direct Communication Setting			
F13.09	Upper Limit Frequency of Torque Control	0.00 - Maximum Frequency F00.16	Hz	50.00	●
F13.10	Upper Limit Frequency Offset	0.00 - Maximum Frequency F00.16	Hz	0.00	●
F13.18	Reverse speed limit	0~100	%	100	●
F13.19	Reverse torque limit	0~1		1	●

F13.08=0: Set through F13.09

Under torque control mode, the upper limit frequency is set through F13.09.

F13.08=1: AI1**F13.08=2: AI2****F13.08=3: AI3****F13.08=4: AI4 (Expansion Card)**

Under the torque control mode, the upper limit frequency is set through AI (percentage) * F13.09

F13.08=5: High-Frequency Pulse Input (X7)

Under the torque control mode, the upper limit frequency is set through HDI (percentage) * F13.09

Please refer to the description of F00.04 for detailed explanations of AI1-AI4 and X7. F00.04 has the same meanings as AI1-AI4 and X7. 100.00% is the percentage inputted through F13.09 (Upper Limit Frequency of Torque Control)

F13.08=6 or 7: Communication Setting of Torque Control Upper Limit Frequency

For master-slave communication (F10.05=1) and the inverter is slave (F10.06=0) the upper limit frequency is 700FH (Communication Setting) * F10.08 (proportional coefficient) * F00.18 (upper limit frequency). The range of 700FH is 100.00% to

100.00%. Details are shown at table 12-2.

For general communication (F10.05=0)

F13.08=6, the upper limit frequency is 700BH (Communication Percentage Setting)

* F13.09 (upper limit frequency)

F13.08=7, the upper limit frequency is 7018H (Communication Setting)

The range of 700BH is 0.00% to 200.00%. The range of 7018H is 0.00 to F00.16 (maximum frequency).

The upper limit frequency of torque control mode is used to set forward or reverse maximum frequency of the inverter.

For torque control mode if the load torque is less than the motor output torque, the motor speed will continue to rise, to prevent mechanical systems appear coasters and other accidents, must limit the highest motor speed; Even if the load is greater than the motor output torque and the motor will be reversed. If F13.19 is set to 1 motor run highest load frequency is still limited, if F13.19 is set to 0 means that the highest motor running load frequency is not restricted.

The reverse upper limit frequency is decided by $F13.09 * F13.18$.

For example, Torque reference is positive, torque control upper limit frequency is input by AI1 analog quantity: When the AI1 analog quantity input is positive, the forward speed amplitude limiting upper limit frequency value is $AI1 (\text{percentage}) * F13.09$, The reverse speed amplitude limiting upper limit frequency value is $AI1 (\text{percentage}) * F13.09 * F13.18$; When the AI1 analog quantity input is negative, the forward speed amplitude limiting upper limit frequency value is $AI1 (\text{percentage}) * F13.09 * F13.18$ The reverse speed amplitude limiting upper limit frequency value is $AI1 (\text{percentage}) * F13.09$.

Torque control maximum operating frequency = torque control upper limit frequency + upper limit frequency offset (only F13.08 = 1 ~ 5 effective), but the maximum operating frequency by F00.16 maximum frequency limit

No.	Function	Range	Unit	Default	Type
F13.11	Static Friction Torque Compensation	0.0 - 100.0	%	0.0	●

F13.12	Static Friction Compensation Frequency Range	0.00 - 50.00	Hz	1.00	●
F13.13	Kinetic Friction Torque Compensation	0.0 - 100.0	%	0.0	●
F13.14 ~ F13.17	Not Used				

In driving an object, motor must overcome the static/kinetic friction. Setting this group of parameters can enable the torque to rotate as per the specified torque after having overcome the inherent static/kinetic friction force. The static friction prevails before motor runs, but the kinetic friction prevails after motor runs. All in all, this group of parameters is related to motor capacity performance.

When the actual frequency (estimated frequency if inverter is in the SVC control mode) is less than or equal to the value set through F13.12, then the output torque is “set frequency + F13.11 Static Friction Torque Compensation”. When the actual frequency is greater than the value set through F13.12, the output torque is “Set Torque + F13.13 Kinetic Friction Torque Compensation”. The greater the compensation is, the higher the compensation level will be. The percentage of the compensation is equal to the torque setting percentage.

7.15 F14 Group: Motor 2 Parameter

EM500 inverter can be switched between two motors. User may perform motor nameplate parameter settings, motor parameter tuning, the selection of VF control or vector control, related parameters of the encoder, and parameters related to VF control or vector control performance for these two motors respectively.

Motor parameters of the second group are listed in F14, with the function codes having the same meanings as that of the first group. F14.00 - F14.34 correspond to F01.00 - F01.34 and they are respectively motor nameplate parameter, motor parameter, encoder

parameter, etc.; F14.35 corresponds to F00.01, for motor control mode; F14.36 - F14.76 corresponds to F06.00 - F06.40, as vector control parameters; F14.77 refers to the acceleration/deceleration options for motor 2. In the following, only F14.72 is described. For the other parameters, please refer to the descriptions of relevant parameter of Motor 1.

No.	Function	Range	Unit	Default	Type
F14.77	Motor 2 Acceleration/Deceleration Time	0: Same as Motor 1 1: Acceleration/Deceleration Time 1 2: Acceleration/Deceleration Time 2 3: Acceleration/Deceleration Time 3 4: Acceleration/Deceleration Time 4		0	○

F14.77=0, the acceleration/deceleration time of motor 2 is the same as that of motor

1. Refer to descriptions of F15.03 - F15.09

F14.72=1/2/3/4, the acceleration/deceleration time of motor 2 is fixed as the acceleration/deceleration time 1, 2, 3 and 4, which correspond to F00.14 - F00.15/F15.03 - F15.04/F15.05 - F15.06/F15.07 - F15.08 respectively

7.16 F15 Group: Auxiliary Function

No.	Function	Range	Unit	Default	Type
F15.00	JOG Frequency	0.00 - Maximum Frequency F00.16	Hz	5.00	●
F15.01	JOG Acceleration Time	0.00 - 6500.0 (F15.13=0) 0.0 - 6500.0 (F15.13=1) 0 - 65000 (F15.13=2)	s	5.00	●
F15.02	JOG Deceleration Time	0.00 - 6500.0 (F15.13=0) 0.0 - 6500.0 (F15.13=1) 0 - 65000 (F15.13=2)	s	5.00	●

As indicated in Figure 7-32, if FJOG/RJOG is enabled, inverter will start running at the frequency set through F15.00; after it is disabled, inverter will stop as per the stop mode.

When inverter is running, F15.01 and F15.02 are set as acceleration and deceleration time. However, the set values (for example 500) have different meanings and ranges, depending upon the time unit (F15.13). If F15.13=0, it means that the acceleration/deceleration time is 5.00s; if F15.13=1, it means that the acceleration/deceleration time is 50.0s.

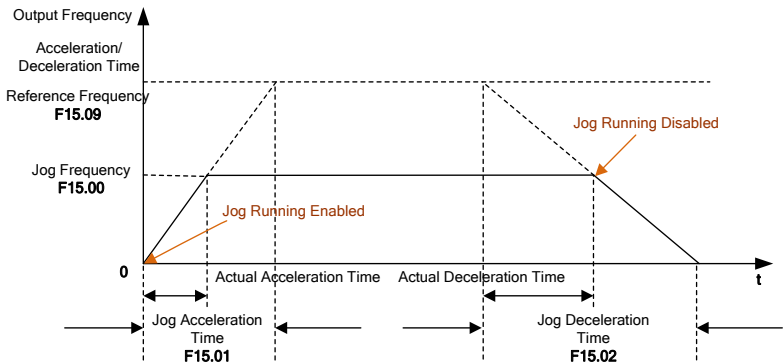

Figure 7-32 Jog Running

★ :JOG running mode, user may independently set frequency and acceleration/deceleration time, which shall not be shared but not having the same physical meaning with normal running

The trigger conditions for JOG running command depend upon inverter control modes. See Table 7-20 for details.

Table 7-20 JOG Running Command

Command Source Options (F00.02)	JOG Running Command
0: Keypad Control	M.K (F12.00) can be set as “1: FJOG” or “2: RJOG”. Press [M.K] , then JOG running command is enabled; release [M.K] , then JOG running command is disabled. ★ Remove the keypad during JOG running to stop inverter
1: Terminal Control	Numeric input terminal function “4: FJOG” or “5: RJOG”. Under default conditions, if the function terminal is enabled, JOG running command is active; if the function terminal is disabled, JOG running command is inactive.

2: Communication Control	If host controller writes “0003H: FJOG” or “0004: RJOG” in the register 7000H through MODBUS protocol, JOG running command will be active; writes “0007H: coast to stop”, JOG running command will be inactive.
--------------------------	---

No.	Function	Range	Unit	Default	Type
F15.03	Acceleration Time 2	0.00 - 650.00 (F15.13=0) 0.0 - 6500.0 (F15.13=1) 0 - 65000 (F15.13=2)	s	15.00	●
F15.04	Deceleration Time 2	0.00 - 650.00 (F15.13=0) 0.0 - 6500.0 (F15.13=1) 0 - 65000 (F15.13=2)	s	15.00	●
F15.05	Acceleration Time 3	0.00 - 650.00 (F15.13=0) 0.0 - 6500.0 (F15.13=1) 0 - 65000 (F15.13=2)	s	15.00	●
F15.06	Deceleration Time 3	0.00 - 650.00 (F15.13=0) 0.0 - 6500.0 (F15.13=1) 0 - 65000 (F15.13=2)	s	15.00	●
F15.07	Acceleration Time 4	0.00 - 650.00 (F15.13=0) 0.0 - 6500.0 (F15.13=1) 0 - 65000 (F15.13=2)	s	15.00	●
F15.08	Deceleration Time 4	0.00 - 650.00 (F15.13=0) 0.0 - 6500.0 (F15.13=1) 0 - 65000 (F15.13=2)	s	15.00	●
F15.09	Acceleration/Deceleration Time Reference Frequency	0: Maximum Frequency F00.16 1: 50.00Hz		0	○

As for normal running (non jog running), the system offers 4 groups of acceleration/deceleration time options (first group F00.14 and F00.15) to meet different demands. After setting, user may switch between the numeric input mode “19: Acceleration/Deceleration Time Terminal 1” and “20: Acceleration/Deceleration Time Terminal 2”. See Table 7-4 Numeric Multi-Function Input Terminals”

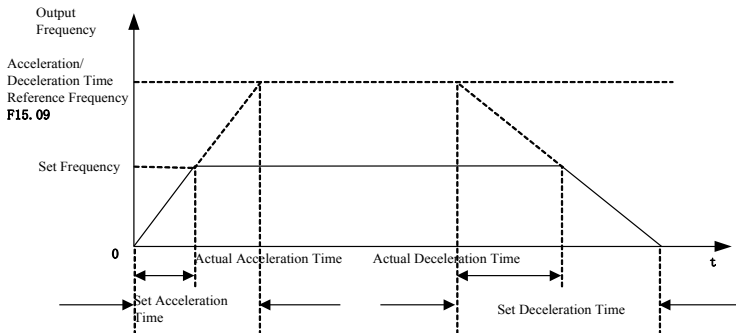

Figure 7-33 Acceleration/Deceleration Time

As indicated in Figure 7-33, the defined acceleration time refers to the time that the frequency increases from 0.00 Hz to the acceleration/deceleration time reference frequency; the deceleration time refers to the time that the frequency decreases from the acceleration/deceleration time reference frequency to 0.00 Hz. Actual acceleration/deceleration time depends upon the ratio of the set frequency to the reference frequency.

F15.09 is used to set the acceleration/deceleration time reference frequency. If F15.09=0, the reference frequency is set by F00.16 (maximum frequency). If also F00.16=100.00 Hz, the acceleration time refers to the time that output frequency increases from 0.00 Hz (100.00 Hz) to 100.00 Hz (0.00 Hz), and the deceleration time refers to the time that output frequency decreases from 100.00 Hz (0.00 Hz) to 0.00 Hz (100.00 Hz)

No.	Function	Range	Unit	Default	Type
F15.10	Automatic Switching between Acceleration and Deceleration Time	0: Disabled 1: Enabled		0	○
F15.11	Switching Frequency between Acceleration Time 1 and Acceleration Time 2	0.00 - Maximum Frequency F00.16	Hz	0.00	●
F15.12	Switching Frequency between Acceleration Time 1 and Acceleration Time 2	0.00 - Maximum Frequency F00.16	Hz	0.00	●

If inverter runs at a common (other than PLC, PID, etc.) speed (other than torque, etc.) of motor 1 and the acceleration and deceleration time terminals (19: Acceleration/Deceleration Time Terminal 1) are disabled, inverter can complete the automatic switching between the two terminals by setting F15.10 as 1. See Figure 7-34 for details.

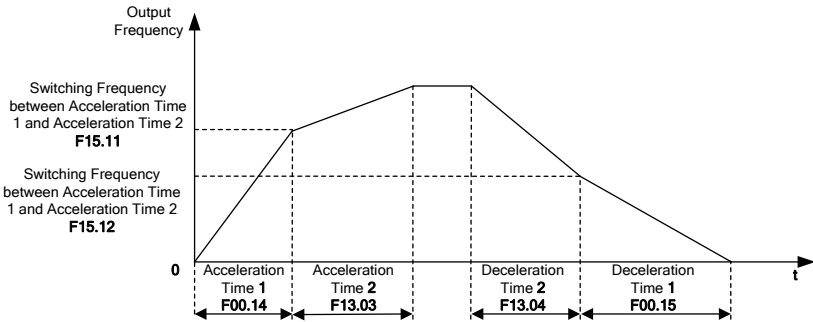

Figure 7-34 Automatic Switching between Acceleration Time and Deceleration Time

In acceleration, if output frequency is less than the value set through F15.11, then the acceleration time 1 is the preset acceleration time, otherwise, the acceleration time 2 is present acceleration time

In deceleration, if output frequency is less than the value set through F15.12, then the deceleration time 1 is the preset deceleration time, otherwise, the deceleration time 2 is present deceleration time.

No.	Function	Range	Unit	Default	Type
F15.13	Acceleration/Deceleration Time Unit	0: 0.01s 1: 0.1s 2:1s		0	○

The acceleration/deceleration time can be a large figure depending upon different working conditions. The system offers 3 kinds of acceleration/deceleration time units, which are set through F15.13. If F15.13=1, it means that the acceleration/deceleration time unit is “0.1 s”. In addition to F13.06 torque control acceleration and deceleration

time, all other acceleration and deceleration time will be changed. In default condition, such as the value of F00.14 ,15.00s will change to 150.0s.

No.	Function	Range	Unit	Default	Type
F15.14	Hopping Frequency Point 1	0.00 - 600.00	Hz	600.00	●
F15.15	Frequency Hopping Range 1	0.00 - 20.00, 0.00: Disabled	Hz	0.00	●
F15.16	Hopping Frequency Point 12	0.00 - 600.00	Hz	600.00	●
F15.17	Frequency Hopping Range 2	0.00 - 20.00, 0.00: Disabled	Hz	0.00	●
F15.18	Hopping Frequency Point 13	0.00 - 600.00	Hz </td <td>600.00</td> <td>●</td>	600.00	●
F15.19	Frequency Hopping Range 3	0.00 - 20.00, 0.00: Disabled	Hz	0.00	●

The hopping frequency function enables inverter output frequency to avoid the mechanical resonance with the mechanical load. Inverter is not permitted to run at a constant speed in the hopping frequency range, but in the acceleration process, there is no hopping and inverter runs smoothly.

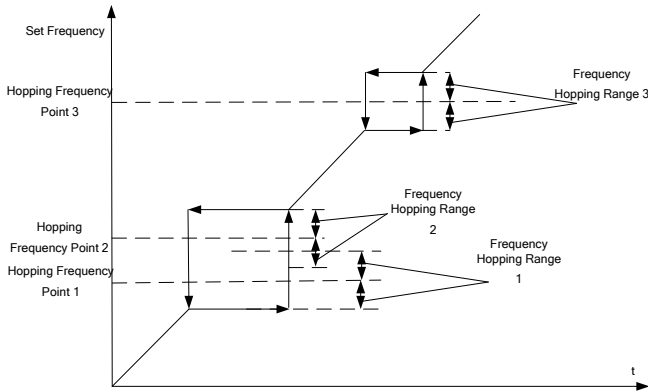

Figure 7-35 Frequency Hopping

As indicated in Figure 7-35, the frequency hopping function is set through “Hopping Frequency Point+Frequency Hopping Range”. Specific frequency hopping is: Hopping Frequency Point-Frequency Hopping Range, Hopping Frequency Point+Frequency Hopping Range. Up to three frequency hopping ranges can be set. When their hopping ranges are all set as 0, corresponding frequency function is disabled.

When the frequency hopping function is enabled and if the set frequency is in the frequency hopping range, then the finally set frequency will be “Hopping Frequency Point-Frequency Hopping Range” during the rising of the set frequency or will be “Hopping Frequency Point+Frequency Hopping Range” during the decrease of the set frequency.

Different frequency hopping ranges may be superposed (see the frequency hopping ranges 1 and 2 in Figure 7-35) and the final frequency hopping range is (Hopping Frequency Point 1-Frequency Hopping Range 1, Hopping Frequency Point 2+Frequency Hopping Range 2)

No.	Function	Range	Unit	Default	Type
F15.20	FAR Detection Bandwidth	0.00 - 50.00	Hz	2.50	○

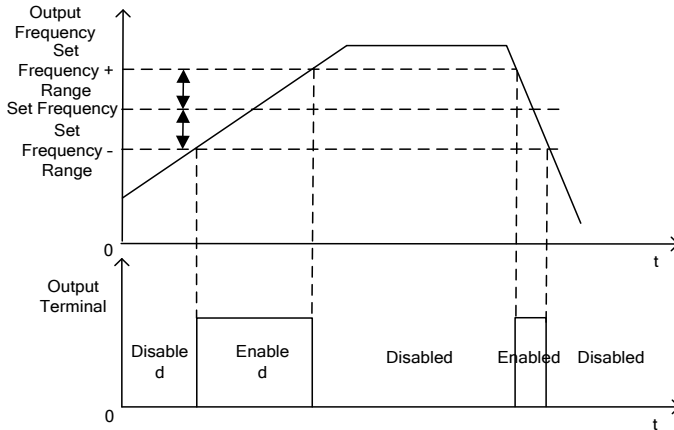

Figure 7-36 FAR Detection

As indicated in Figure 7-36, when the multi-function output terminal or relay output is set as “2: FAR”, if the absolute value of the difference between output frequency and the set input frequency is less than or equal to FAR (F15.20) during inverter running (non-autotuning), the multi-function output terminal outputs active level, otherwise the multi-function output terminal outputs inactive level.

No.	Function	Range	Unit	Default	Type
F15.21	Output Frequency Detection Range FDT1	0.00 - Maximum Frequency F00.16	Hz	30.00	○
F15.22	FDT1 Hysteresis	$-(F_{max}-F15.21) \sim F15.21$	Hz	2.00	○
F15.23	Output Frequency Detection Range FDT2	0.00 - Maximum Frequency F00.16	Hz	20.00	○
F15.24	FDT2 Hysteresis	$-(F_{max}-F15.23) \sim F15.23$	Hz	2.00	○

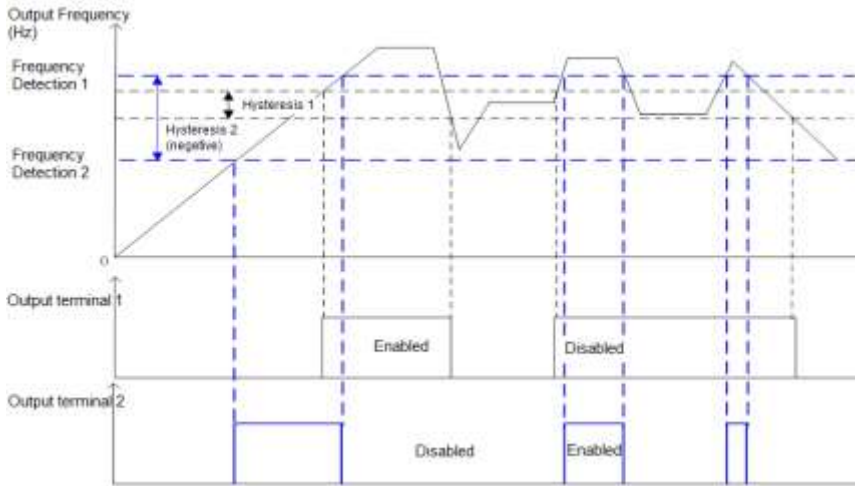

Figure 7-37 FDT Detection

As indicated in Figure 7-37, when the multi-function output terminal or relay output is set as “3: Output Frequency Detection Range FDT1” or “4: Output Frequency Detection Range FDT2”, if the absolute value of output frequency is greater than output frequency Detection Range FDT1/2 (F15.21/F15.23), corresponding function terminal outputs active level during inverter running; if the absolute value of output frequency drops to a value less than or equal to “Output Frequency Detection Range FDT1/2 (F15.21/F15.23) - FDT1/2 hysteresis”, corresponding function terminal outputs inactive level; if the absolute value of output frequency falls between “Output Frequency Detection Range - Hysteresis” and “Output Frequency Detection Range”, the output level of corresponding function terminal remains the same.

No.	Function	Range	Unit	Default	Type
F15.25	Analog Input Level Detection ADT	0: AI1 1: AI2 2: AI3 3: AI4(Expansion Card)		0	○
F15.26	Analog Input Level Detection ADT1	0.00 - 100.00	%	20.00	●
F15.27	ADT1 Hysteresis	0.00 - F15.26(Monotonic decreasing is active)	%	5.00	●
F15.28	Analog Input Level Detection ADT2	0.00 - 100.00	%	50.00	●
F15.29	ADT2 Hysteresis	0.00 - F15.28(Monotonic decreasing is active)	%	5.00	●

The analog level detection can be used to detect and monitor present setting of F15.25 and also for internal operation, external alarm monitoring, etc. Two detection conditions can be set, but the detection is only for one analog input channel.

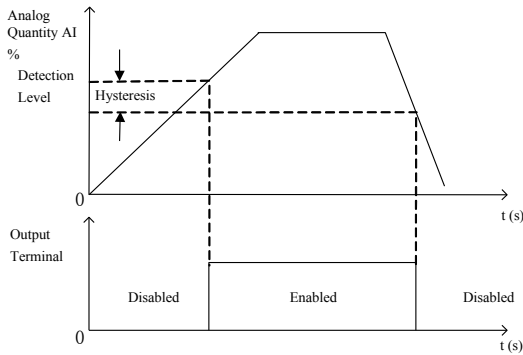

Figure 7-38 ADT Detection

As indicated in Figure 7-38, the detection level has been set with a valid start point. When the analog input has been processed for offset and after this, its percentage is greater than the detection level, the function ADT is enabled; if the conditions for “disable” are determined by the monotonic decreasing hysteresis, when the transformation result of the input analog is reduced to a value below “Detected Level - Hysteresis”, the function ADT is disabled

No.	Function	Range	Unit	Default	Type
F15.30	Energy	0: Disabled		0	○

	Consumption Brake	1: Enabled			
F15.31	Energy Consumption Brake Operation Voltage	110.0 - 140.0 (380V, 100.0=537V)	%	125.0 (671V)	●
F15.32	Brake Duty Ratio	20 - 100 (100 means that the duty ratio is 1)	%	100	●

Energy consumption brake is a brake method by transforming the electric energy generated during the speed reduction into the heat energy of the braking resistor to realize rapid brake. It applies to the brake of large inertia or occasions requiring rapid brake and stop. User needs to choose proper braking resistor and braking unit. See 11.1 Braking Resistor and 11.2 Braking Unit.

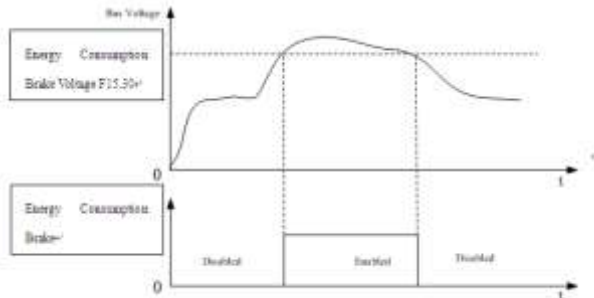

Figure 7-39 Energy consumption brake

As indicated in Figure 7-39, when Energy consumption brake is enabled (F15.30=1) and bus voltage is greater than the operation voltage of Energy consumption brake (F15.31), Energy consumption brake starts; when bus voltage drops to a value below a certain value, Energy consumption brake is disabled.

When inverter is in energy consumption brake, IGBT in the braking unit is on and the energy can be discharged rapidly through braking resistor. Brake duty ratio (F15.32) describes the duty ratio when IGBT is on. The higher the duty ratio is, the higher the brake level will be.

No.	Function	Range	Unit	Default	Type
F15.33	Control Mode of Set Frequency Lower Than Lower Limit Frequency	0: Run at Lower Limit Frequency 1: Stop		0	○

When the set frequency of inverter is lower than the lower limit frequency (F00.19), the control mode can be set through F15.33

No.	Function	Range	Unit	Default	Type
F15.34	Fan Control	0: Run at Energization 1: Run at Star 2: Run at Intelligent Temperature Control		1	○

Three fan control modes are available to reasonably use the fan. It is controlled through F15.34 See Table 7-21 for control modes of fan

Table 7-21 Fan Running

Fan Control	Description
0: Run at Energization	Fan runs immediately after inverter is powered on.
1: Run at Star	Fan starts running after inverter starts running; fan stops running 1 minute after inverter enters the parameter setting status.
2: Run at Intelligent Temperature Control	When inverter temperature > 45 °C, fan starts running; when inverter temperature < 40 °C, fan stops running; when inverter temperature is not less than 40 °C, but not greater than 45 °C, fan keeps running.

★ If “2: Run at Intelligent Temperature Control” is selected, make sure that inverter temperature detection module works normally.

No.	Function	Range	Unit	Default	Type
F15.35	Over modulation Intensity	1.00 - 1.10		1.05	●

When the input voltage of inverter is lower than its output frequency, user may increase the over modulation intensity to enhance the utilization factor of bus voltage and increase the upper limit of output voltage. If F15.35=1.10, the upper limit of the voltage may be increased by up to 10%, output current at load may be reduced, but the current harmonic will go up

No.	Function	Range	Unit	Default	Type
F15.36	PWM Modulation Method Switching Options	0: Disabled (7 preset PWM modulation) 1: Enabled (5 preset PWM modulation)		0	○
F15.37	PWM Modulation Method Switching Frequency	0.00 - Maximum Frequency F00.16	Hz	15.00	●

For PWM modulation method, if F15.36=0, the 7 preset PWM modulation always applies; if F15.36=1, the 7 preset PWM modulation applies when output frequency is lower than the switching frequency (F15.37), or the 5 present PWM modulation applies when output frequency is greater than the switching frequency. In comparison with the 5 preset PWM modulation mode, the current ripple wave for the 7 preset PWM modulation mode is smaller, but the switching loss is higher, and inverter would have a higher heating level and a higher temperature rise.

No.	Function	Range	Unit	Default	Type
F15.38	Deadband Compensation Mode	0: Disabled 1: Compensation Mode 1 2: Compensation Mode 2		1	○

User does not need to change the option of this function code. Only when there are special requirements on output voltage waveform quality or motor is in an abnormal status (for example oscillation) would user try to select a different compensation mode.

Generally, the compensation mode 1 is selected, but user may select the compensation mode 2 in case of high power and VF control, which may easily cause motor oscillation.

No.	Function	Range	Unit	Default	Type
F15.39	Terminal Jog Priority	0: Disabled 1: Enabled		0	○

Under terminal control mode (F00.02=1), this function code is used to select whether there is jog priority. For the terminal jog priority (F15.39=1), inverter changes to the jog running status if the jog terminal is enabled, even if inverter is running; if F15.39=0, inverter cannot change to the jog running status from the running status directly.

No.	Function	Range	Unit	Default	Type
F15.40	Deceleration Time at Rapid Stop	0.00 - 650.00 (F15.13=0) 0.0 - 6500.0 (F15.13=1) 0 - 65000 (F15.13=2)	s	1.00	●

This function code refers to the setting of the acceleration/deceleration time while inverter is in “rapid stop”.

No.	Function	Range	Unit	Default	Type
F15.44	Phase Angle Adjustment Enabled	0: Start Using 1: Shut Down		0	●

F15.44=0 Start Using

Start phase sequence phase detection function

F15.44=1 Shut Down

Closed phase sequence phase detection function



1. Phase sequence phase detection function is valid only for the synchronous machine, and it must be equipped with phase sequence phase detection card can be used.

No.	Function	Range	Unit	Default	Type
F15.45	Frequency Converter -Power frequency Switch The Way	0: Automatic switch 1: Manual switch		0	○
F15.46	The Switching Time	0~1000	ms	100	○

F15.45=0 Automatic switch

When the specified phase angle difference is reached, the inverter will automatically switch over.

Switching action sequence first inverter seal output tube, and then the output terminals function inverter start to finish (52function) output is invalid, delay F15.46 time, power frequency switch effect (53function)

F15.45=1 Manual switch

Manual switching is when the specified phase angle difference is reached, the phase angle difference remains unchanged until the power frequency conversion (function 80 is active) is closed, the system to switch.

No.	Function	Range	Unit	Default	Type
F15.47	Phase card startup latency	0~1000	ms	100	○

Before running the Inverter Startup Is Completed terminal output is invalid (52 function), as running, at first the terminal function is valid, then delay F15.46 time, the inverter starts to output.

No.	Function	Range	Unit	Default	Type
F15.48	Direction of the phase Angle	0: Advanced 1: Lag		0	○
F15.49	Phase Angle Difference	0~180	°	0	●

Used to specify the phase angle difference between the actual output phase angle and the detection point.



1. If the RST phase angle is detected, the UVW phase angle is adjusted accordingly

No.	Function	Range	Unit	Default	Type
F15.50	The current phase Angle error	-180~180		0	●

Used to monitor the current phase Angle error.

No.	Function	Range	Unit	Default	Type
F15.51	The phase adjusting gain	0.00-600.00		1.00	×
F15.52	Phase-locked loop proportional gain	0.00~600.00		0.00	●
F15.53	Phase-locked loop integral gain	0.00~600.00		0.00	●
F15.54	Phase-locked loop filtering time	0.00~100.00	ms	0.50	●

Phase sequence phase detection related parameters, generally do not adjust

7.17 F16 Group: User Defined Function Parameter

No.	Function	Range	Unit	Default	Type
F16.00	Industry Application	0: General models 1: Application of Water supply 2: Application of Air compressor 3: Application of Winding rolling	Air	0	○

F16.00=0: General models

As a General models inverter, the application-related functions are not enabled

F16.00=1: Application of Water supply

Using PID adjustment of constant pressure water supply control, and optional clock card, it can provide clock pressure setting function.

F16.00=2: Application of Air compressor

Using PID adjustment of air compressor control, and optional air compressor interface card, PT100 temperature can be calculated automatically.

F16.00=3: Application of Winding

PID control with dancer feedback.



Changing this function code activates the corresponding functions only, please manually restore the factory settings through F12.14 to obtain special parameters.

No.	Function	Range	Unit	Default	Type
F16.01	Set up length	1~65535 (F16.13=0) 0.1~6553.5 (F16.13=1) 0.01~655.35 (F16.13=2) 0.001~65.535 (F16.13=3)	m	1000	●
F16.02	Pulse Count Per Meter	0.1 - 6553.5		100.0	●
F16.13	Set Resolution Of The Length	0: 1m 1: 0.1m 2: 0.01m 3: 0.001m		0	○

EM500 inverter has the fixed length count function (refer to Figure 7-40). Inverter

must input the length information via the numeric input terminal in the form of pulse before setting relevant function codes to complete the length count function. The completion information of the final length count can be outputted via the numeric output terminal and other methods for other purposes (for example, input it via DI/VX to be used as a stop command). User may also view present length count value through F18.34.

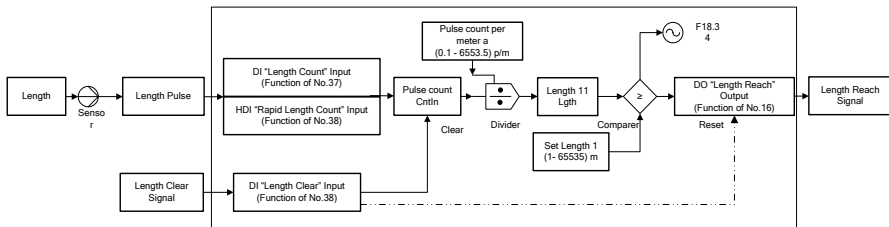

Figure 7-40 Block Diagram of Fix Length Count Function

Operation principle: The length detection sensor transforms the length information into the pulse information; DI terminal collects the input pulse number N ; according to

the setting of “Pulse Count per Meter” as α , we can know that the length is $l_1 = \frac{N}{\alpha}$, and

then compare it with the “Set Length l ”. If $l_1 < l$, it means that the length has not reached the set value; otherwise, this function is completed. “39: Length Clear” is used to clear the count and reset the output signal.

If the pulse frequency is greater than 250 Hz ($=1/(2(\text{default filter times}) * 2 * 1 \text{ms}^{-1})$), please complete the input via X7 and set F02.06 as “38: High-Speed Length Count Input”. 250 Hz is just a theoretical value. The actual value will apply. To avoid any mistake, please use the high speed pulse input terminal.

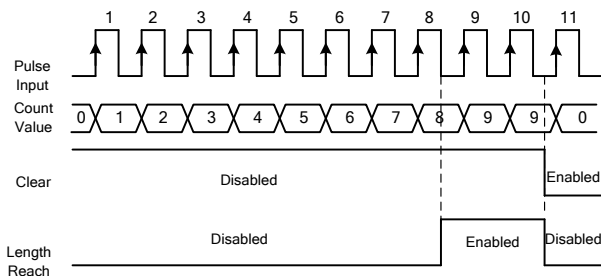

Figure 7-41 Fixed Length Count (Example)

When the length count reaches 8(=2×4), “16: Length Reach” is enabled; when “39: Length Clear” is enabled, the count will be cleared and “16: Length Reach” output is disabled.

No.	Function	Range	Unit	Default	Type
F16.03	Set Count Value	F16.04 - 65535		1000	●
F16.04	Designated Count Value	1 - F16.03		1000	●

EM500 inverter supports the count function (refer to Figure 7-42). The pulse information is inputted via the numeric input terminal. When the count reaches a set value, corresponding signal will be outputted. User may perform the programming with this signal (for example input it via DI/VX to be used as a stop command). User may view present count value via F18.33 in real time.

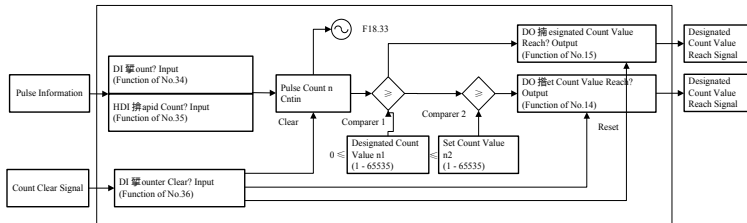

Figure 7-42 Block Diagram of Count Function

Principle of work: When certain information is inputted in the form of pulse. DI terminal collects the information about the input pulse number n , and then compare it with the “Designated Count Value n_1 ”. If $n < n_1$, it means that the “Set Count Value” has not been reached, otherwise it finishes and this result is output in the form of the terminal DO. Continue the count and compare it with the “Set Count Value. If $n < n_2$, it means that the “Set Count Value” has not been reached, otherwise it finishes and this result is outputted in the form of the terminal DO with the count stopping. “36: Counter Clear” is used to clear the counter and reset the output signal.

If the pulse frequency is greater than 250 Hz (=1/(2(default filter times)*2*1ms⁻¹)), please complete

the input via X7 and set F02.06 as “35: High-Speed Count Input”: 250 Hz is just a theoretical value. The actual value will apply. To avoid any mistake, please use the high speed pulse input terminal.

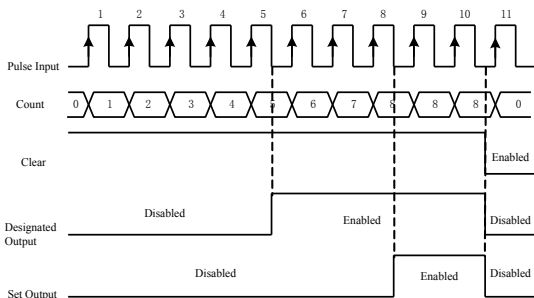

Figure 7-43 Count (Example)

Figure 7-43 is an example. In the figure, F16.03=8 and F16.04=5. When the count reaches 5, “15: Designated Count Value Reach” is enabled; when the count reaches 8, “14: Set Count Value Reach” is enabled; when “36: Counter Clear” is enabled, the count will be cleared and both “15: Designated Count Value Reach” and “14: Set Count Value Reach” are disabled.

Set $65535 \geq \text{Set Count Value} \geq \text{Set-up Count Value} \geq 0$; if set count value = designated count value=0, then the counter is disabled; only one terminal can be set with this function for the same time.

No.	Function	Range	Unit	Default	Type
F16.05	Set Timed Running time	0.0 - 6500.0, 0.0: Disabled	min	0.0	●

This function code shall not be set as 0 to start the timed run function. When the running time reaches the set value, inverter stops and output terminal of the function “26: Set Time Reach” is enabled, with a prompt for the reach to the running time.

User may view the remaining time through F18.35 or clear the preset running time by the input function “27: Clear Timed Running time” (i.e., reset F18.35).When inverter is not running, this time indicates the set time; when inverter is running, this time refers

to the remaining time. That is to say, a timed run procedure starts from inverter running. After inverter stops, the accumulated time is cleared.

No.	Function	Range	Unit	Default	Type
F16.06	Agent Password	0 - 65535		0	○

Agent Password

★ By setting this password, inverter may not be used normally. Please pay enough attention.

No.	Function	Range	Unit	Default	Type
F16.07	Set Accumulated Power-On Time Reach	0 - 65535, 0: Power-on Reach Time Protection Disabled	h	0	○

These codes are used to set the accumulated power-on reach time. When the accumulated power-on time (F12.15/16) \geq the accumulated power-on reach time (F16.07), inverter can not be used.

★ By setting this parameter, inverter may not be used normally. Please pay enough attention

No.	Function	Range	Unit	Default	Type
F16.08	Set Accumulated Running arrival time	0 - 65535, 0: Running time Reach Protection Disabled	h	0	○

This function is used to set accumulated running arrival time. When accumulated running time, if (F12.17/18) \geq the set accumulated running arrival time (F16.08), inverter can not be used.

★ By setting this parameter, inverter may not be used normally. Please pay enough attention

No.	Function	Range	Unit	Default	Type
F16.09	Factory Password	0 - 65535		XXXXXX	●

Factory Password

★ By setting this password, inverter may not be used normally. Please pay enough attention

No.	Function	Range	Unit	Default	Type
-----	----------	-------	------	---------	------

F16.10	The percentage of analog output when the count value of zero	0.00~100.00	%	0.00	○
F16.11	The percentage of analog output when the count value of Designated Count Value	0.00~100.00	%	100.00	○

The analog output is set to count and length of the output of the offset Settings.

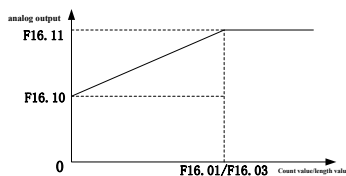

Figure 7-44 Count value and length value analog output

No.	Function	Range	Unit	Default	Type
F16.12	EC - A card slot expansion card type	0: No Expansion Card 1: Clock Card 2: Air compressor interface Card 3: Phase sequence phase detection card		0	○

F16.12=0: No Expansion Card

No expansion card means that the Inverter does not require a new function provided by the interface card

F16.12=1: Clock Card

Clock card used in the water supply industry, it can provide timing water supply function

F16.12=2: Air compressor interface Card

Air compressor interface Card used in Air compressor industry, it can be applied to the provided by SINEE.

F16.12=3: Phase sequence phase detection card.

Phase sequence phase detection card is an independent function, not associated with industry applications. After using the phase sequence phase interface card The inverter can realize synchronous motor soft start after switching to power frequency.



1. After installing the optional card, you need to set F 16.12 to enable the corresponding function. Please set F16.12 and then power off when installed for the first time, then you can install the optional card.
2. Please replace the interface card after the LED light of the inverter turns off
3. The phase sequence phase detection card is only applied to the synchronous motor

7.18 F17 Group: Virtual I/O Function Parameter

EM500 inverter has 8 multi-function virtual input terminals (VX1 - VX8). Their functions and use methods are basically the same as actual input terminals. In the following, only the difference will be described. For the same functions and use methods as that of actual input terminals, please refer to the descriptions of F02 Input Terminal Function Parameters.

No.	Function	Range	Unit	Default	Type
F17.00	VX1 Virtual Input Function	Same as the options of F02 group numeric input terminals, please refer to Table 7-2 Functions of Numeric Multi-Function Input Terminals		0	○
F17.01	VX2 Virtual Input Function			0	○
F17.02	VX13 Virtual Input Function			0	○
F17.03	VX4 Virtual Input Function			0	○
F17.04	VX5 Virtual Input Function			0	○
F17.05	VX6 Virtual Input Function			0	○
F17.06	VX7 Virtual Input Function			0	○
F17.07	VX8 Virtual Input Function			0	○

Function												
F17.08	Positive/Negative Logic of Virtual Input	D7	D6	D5	D4	D3	D2	D1	D0		000 00000	○
		VX8	VX7	VX6	VX5	VX4	VX3	VX2	VX1			
		0: Positive Logic, Enabled at On/Disabled at Off 1: Negative Logic, Disabled at On/Enabled at Off										
F17.11	VX1 Effective Delay Time	0.000 - 30.000								s	0.000	●
F17.12	VX1 Ineffective Delay Time	0.000 - 30.000								s	0.000	●
F17.13	VX2 Effective Delay Time	0.000 - 30.000								s	0.000	●
F17.14	VX2 Ineffective Delay Time	0.000 - 30.000								s	0.000	●
F17.15	VX3 Effective Delay Time	0.000 - 30.000								s	0.000	●
F17.16	VX3 Ineffective Delay Time	0.000 - 30.000								s	0.000	●
F17.17	VX4 Effective Delay Time	0.000 - 30.000								s	0.000	●
F17.18	VX4 Ineffective Delay Time	0.000 - 30.000								s	0.000	●

In terms of functions, VX1 - VX8 are basically the same; they do not have an actual physical terminal, but they all have the positive/negative logic function. VX1 - VX4 have the delay function, with the same terminal status confirmation method; they can be set respectively. An example is given to VX1 in the following part.

No.	Function	Range								Unit	Default	Type
F17.09	VX1 - VX8 Status Setting	D7	D6	D5	D4	D3	D2	D1	D0		000 00000	○
		VX8	VX7	VX6	VX5	VX4	VX3	VX2	VX1			
		0: VXn Is Same as VYn Output 1: Status to be Set by F17.10										
F17.10	VX1 - VX8 Status Setting	D7	D6	D5	D4	D3	D2	D1	D0		000 00000	●
		VX8	VX7	VX6	VX5	VX4	VX3	VX2	VX1			
		0: Disabled 1: Enabled										

- If F17.09=xxxxxxx0, VX1 status and VY1 output status are the same.

As mentioned above, the virtual input terminal has the same status as the virtual output terminal. At this time, it needs to be used together with the virtual output terminal.

If F17.19=16 and F17.28=0bxxxx xxx1 (VY1 output status is determined by the output function status) under default conditions, then when “16: Length Reach” is enabled, VY1 is enabled and VX1 is enabled as well; at this time, setting this function as per VX1 (assuming 39: Length Clear) to complete corresponding operations (clear the length count and reset VY1). Now, the fixed length count function can start again to realize the repeated processing requirements. If time interval is needed for repeated processing times, we can realize this function by VX1 delay.

If F17.09=xxxxxxx1, the status of VX1 is determined by the bit0 of the function code F17.10

The status of the virtual input terminals can be set by the function codes. This method is mainly used for the remote control of host controller. The remote control terminal may use the function code 0x41 to change the status setting of F17.10 (enabled or disabled) via communication.

EM500 inverter has 8 multi-function virtual output terminals (VY1 - VY8). Their functions and use methods are basically the same as actual output terminals. In the following, only the difference will be described. For the same functions and use methods as that of actual input terminals, please refer to the descriptions of F03 Output Terminal Function Parameter.

No.	Function	Range	Unit	Default	Type
F17.19	VY1 Virtual Output Function	Same as the options of F03 group numeric output terminals, please refer to Table 7-6 Numeric Multi-Function Output Terminals		0	○
F17.20	VY2 Virtual Output Function			0	○
F17.21	VY3 Virtual Output Function			0	○
F17.22	VY4 Virtual Output			0	○

	Function											
F17.23	VY5 Virtual Output Function									0	○	
F17.24	VY6 Virtual Output Function									0	○	
F17.25	VY7 Virtual Output Function									0	○	
F17.26	VY8 Virtual Output Function									0	○	
F17.27	Positive/Negative Logic of Virtual Input	D7	D6	D5	D4	D3	D2	D1	D0	000 0000 0	○	
		VY8	VY7	VY6	VY5	VY4	VY3	VY2	VY1			
		0: Positive Logic, Enabled at On/Disabled at Off 1: Negative Logic, Disabled at On/Enabled at Off										
F17.29	VY1 Effective Delay Time	0.000 - 30.000								s	0.000	●
F17.30	VY1 Ineffective Delay Time	0.000 - 30.000								s	0.000	●
F17.31	VY2 Effective Delay Time	0.000 - 30.000								s	0.000	●
F17.32	VY2 Ineffective Delay Time	0.000 - 30.000								s	0.000	●
F17.33	VY3 Effective Delay Time	0.000 - 30.000								s	0.000	●
F17.34	VY3 Ineffective Delay Time	0.000 - 30.000								s	0.000	●
F17.35	VY4 Effective Delay Time	0.000 - 30.000								s	0.000	●
F17.36	VY4 Ineffective Delay Time	0.000 - 30.000								s	0.000	●

In terms of functions, VY1 - VY8 are basically the same; they do not have an actual physical terminal, but they all have the positive/negative logic function. VY1 - VY4 have the delay function, with the same terminal status confirmation method; they can be set respectively. An example is given to VY1 in the following part.

No.	Function	Range								Unit	Default	Type
F17.28	Virtual Output Terminal Control	D7	D6	D5	D4	D3	D2	D1	D0		111 11111	○
		VY8	VY7	VY6	VY5	VY4	VY3	VY2	VY1			
		0: To be determined by the status										

		of X1 – X7(No VY8) 1: To be determined by the output function status			
--	--	---	--	--	--

If F17.28=xxxxxxx0, VY1 status and X1 input status are the same.

The status of VY1 is synchronized with actual input status X1. This application can be used for status confirmation and one switch motion can be used for realizing the programming of multiple functions, etc

- If F17.28=xxxxxxx1, the status of VY1 is determined by F17.19.

The status of the virtual output terminal is determined by the set status. Such output is mainly used for soft programming. For example, we can output the signal of “19: PID Feedback Upper Limit Reach” via VY1 (F17.19=19), and collect the signal via VX1 (F17.00=41), in order to control PID via the function code “PID Feedback Upper Limit Reach”.

No.	Function	Range								Unit	Default	Type
F17.37	Virtual Input Terminal Status	VX8	VX7	VX6	VX5	VX4	VX3	VX2	VX1		000 00000	×
		0: Disabled 1: Enabled										
F17.38	Virtual Output Terminal Status	VY8	VY7	VY6	VY5	VY4	VY3	VY2	VY1		000 00000	×
		0: Disabled 1: Enabled										

These function codes are used to display present virtual terminal status in real time.

7.19 F18 Group: Monitoring Parameter

This group of parameters can be used for viewing present status of inverter, but cannot be used to operate them.

No.	Function	Range	Unit
F18.00	Output Frequency	Display present output frequency. Range: 0.00 - Upper Limit Frequency ★ This parameter will be updated in real time only when inverter is in speed control mode.	Hz
F18.01	Set Frequency	Display present set frequency. Range: 0.00 - Maximum Frequency F00.16 ★ This parameter will be updated in real time only when inverter is in speed control mode.	Hz
F18.02	Not Used		
F18.03	Estimated Feedback Frequency	Used to display estimated feedback frequency when inverter is in SVC control mode. Range: 0.00 - Upper Limit Frequency	Hz

		★ This parameter will be updated in real time only when inverter is in SVC control mode.	
F18.04	Output Torque	Display present output torque of inverter. Range: -200.0 - 200.0.	%
F18.05	Torque Setting	Display present set torque of inverter. Range: -200.0 - 200.0. ★ This parameter will be updated in real time only when inverter is under torque control mode.	%
F18.06	Output Current	Display present output current of inverter. According to motor rated power ratings: 0.00 - 650.00 (Motor Rated Power ≤ 75kW) 0.0 - 6500.0 (Motor Rated Power >75kW)	A
F18.07	Output Current Percentage	Display present output current in the form of percentage (relative to inverter rated current). Range: 0.0 - 300.0.	%
F18.08	Output Voltage	Display present output voltage. Range: 0.0 - 690.0.	V
F18.09	DC Bus Voltage	Display present bus voltage. Range: 0 - 1200.	V
F18.10	Simple PLC Running Times	When auxiliary frequency source B is involved in setting (F00.06≠0), by setting “11: Simple PLC” (F00.05=11) and the simple PLC running mode is “Limited Times of Cycles” (F08.15=1/2), inverter will display present running times; “0” means that it is the first time, “1” means that it has finished the first time and is running for the second time, and so on. Range: 0 - F08.16.	
F18.11	Simple PLC Running Stage	When auxiliary frequency source B is involved in setting (F00.06≠0), by setting “11: Simple PLC” (F00.05=11), inverter will display present running PLC running stage. Range: 1-15, which corresponds to preset speed 1 (F08.00) – preset speed 15 (F08.14) respectively.	
F18.12	PLC Running Time of Present Stage	When auxiliary frequency source B is involved in setting (F00.06≠0), by setting “11: Simple PLC” (F00.05=11), inverter will display present running PLC running stage. Range: 0.0 – Corresponding Time Setting (for example the time of preset speed is determined by F08.20).	s / min
F18.13	Not Used		

F18.14	Load Speed	Display present load speed. For normal display, please set the load speed display factor (F12.09). Range: 0 - 65535.	rpm												
F18.15	UP/DOWN Offset Frequency	Used to display UP/DOWN offset frequency. For details, please refer to the descriptions of UP/DOWN Function of F12.10 - F12.12.	HHz												
F18.16	PID Setting	Used to display present PID setting; divide it by F09.03 to get present percentage setting.													
F18.17	PID Feedback	Used to display present PID feedback; divide it by F09.03 to get present percentage setting.													
F18.18	Kilowatt-Hour Meter, MWh	Used to display the accumulated input (output + fan) energy consumption (MWh). Used together with F18.19 to confirm present energy consumption.	MWh												
F18.19	Kilowatt-Hour Meter, kWh	Used to display the accumulated input (output + fan) energy consumption (kWh). Used together with F18.18 to confirm present energy consumption.	kWh												
F18.20	Output Power	Display present output power. Range: 0.00 - 650.00.	kW												
F18.21	Output Power Factor	Display present output power factor. Range: -1.00 - 1.00.													
F18.22	Numeric Input Terminal Status 1	Display present active status of input terminals X1 - X5. The five-digit nixie tube will display the following information from left to right:													
		<table border="1" style="width: 100%; text-align: center;"> <tr> <td>X5</td> <td>X4</td> <td>X3</td> <td>X2</td> <td>X1</td> <td></td> </tr> <tr> <td>0/1</td> <td>0/1</td> <td>0/1</td> <td>0/1</td> <td>0/1</td> <td></td> </tr> </table>	X5	X4	X3	X2	X1		0/1	0/1	0/1	0/1	0/1		
		X5	X4	X3	X2	X1									
0/1	0/1	0/1	0/1	0/1											
Actual display: 00001 ★ 0: disabled; 1: enabled.															
F18.23	Numeric Input Terminal Status 2	Display present active status of input terminals X6/X7/AI1 - AI3. The five-digit nixie tube will display the following information from left to right:													
		<table border="1" style="width: 100%; text-align: center;"> <tr> <td>AI3</td> <td>AI2</td> <td>AI1</td> <td>X7</td> <td>X6</td> <td></td> </tr> <tr> <td>0/1</td> <td>0/1</td> <td>0/1</td> <td>0/1</td> <td>0/1</td> <td></td> </tr> </table>	AI3	AI2	AI1	X7	X6		0/1	0/1	0/1	0/1	0/1		
		AI3	AI2	AI1	X7	X6									
0/1	0/1	0/1	0/1	0/1											
Actual display: 00000 ★ For EM500 inverter, analog input terminals AI1 - AI3 can be used for numeric input only. ★ 0: disabled; 1: enabled.															
F18.24	Numeric Input Terminal Status 3	Display present active status of input terminals X8 - X11/ AI4. The five-digit nixie tube will display the following information from left to right:													
		<table border="1" style="width: 100%; text-align: center;"> <tr> <td>AI4</td> <td>X11</td> <td>X10</td> <td>X9</td> <td>X8</td> <td></td> </tr> <tr> <td>0/1</td> <td>0/1</td> <td>0/1</td> <td>0/1</td> <td>0/1</td> <td></td> </tr> </table>	AI4	X11	X10	X9	X8		0/1	0/1	0/1	0/1	0/1		
		AI4	X11	X10	X9	X8									
0/1	0/1	0/1	0/1	0/1											

		Actual display: 00000 ★ Display terminals for this function code are all expansion card (EC-IO-A1) terminals. Please perform configuration before use. ★ 0: disabled; 1: enabled.											
F18.25	Output Terminal Status	Display present active status of output terminals R1/R2/Y1/Y2. The five-digit nixie tube will display the following information from left to right:											
		<table border="1"> <tr> <td>Y3</td> <td>R2</td> <td>R1</td> <td>Y2</td> <td>Y1</td> </tr> <tr> <td>0/1</td> <td>0/1</td> <td>0/1</td> <td>0/1</td> <td>0/1</td> </tr> </table>	Y3	R2	R1	Y2	Y1	0/1	0/1	0/1	0/1	0/1	
		Y3	R2	R1	Y2	Y1							
0/1	0/1	0/1	0/1	0/1									
Actual display: 01010. ★ Numeric output terminal Y3 is an expansion card (EC-IO-A1) terminal. Please perform configuration before use. ★ 0: disabled; 1: enabled.													
F18.26	AI1	Used to display the standard value of present analog input channel 1 (AI1) corresponding to 100.0%. Range: 0.0 - 100.0.	%										
F18.27	AI2	Used to display the standard value of present analog input channel 2 (AI2) corresponding to 100.0%. Range: 0.0 - 100.0.	%										
F18.28	AI3	Used to display the standard value of present analog input channel 3 (AI3) corresponding to 100.0%. Range: 0.0 - 100.0.	%										
F18.29	AI4	Used to display the standard value of present analog input channel 4 (AI4) corresponding to 100.0%. Range: -100.0 - 100.0. ★ Analog input terminal AI4 is an expansion card (EC-IO-A1) terminal. Please perform configuration before use.	%										
F18.30	Communication Setting	Not used	%										
F18.31	High-Speed Pulse Input Frequency: kHz	Used to display the input pulse frequency of present high-speed pulse input channel HDI (X7). Minimum resolution: 0.01 kHz. Range: 0.00 - 100.00.	kHz										
F18.32	High-Speed Pulse Input Frequency: Hz	Used to display the input pulse frequency of present high-speed pulse input channel HDI (X7). Minimum resolution: 1 kHz. Range: 0 - 65535. If actual input frequency > 65535 Hz, display value is 65535.	Hz										
F18.33	Count Value	Used to display the number of input pulses of present											

		high-speed pulse input channel HDI (X7). See F16.03 and F16.04. Range: 0 - F16.03.	
F18.34	Actual Length	Used to display the actual length of the workpiece being processed (by transformation from HDI (X7) as per relevant setting) of input pulses of present high-speed pulse input channel HDI (X7). See F16.01 and F16.02. Range: 0 - F16.01.	m
F18.35	Remaining Time of Timed Run	Used to display the remaining time of the timed run. See F16.05. Range: 0.0 - F16.05.	min
F18.36	Position of Rotor of Synchronous Motor	Position of rotor of synchronous motor. Range: 0.0 - 359.9.	°
F18.37	Rotary Transformer Position	Used to display the rotary transformer position. Range: 0 - 4095.	
F18.38	Motor Temperature	Used to display motor temperature collected by the analog channel 4 (AI4). Range: 0 - 200.	°C
F18.39	VF Separation Target Voltage	Used to display VF separation target voltage in real time. Range: 0.0 - Motor Rated Voltage.	V
F18.40	VF Separation Output Voltage	Used to display VF separation output voltage in real time. Range: 0.0 - Motor Rated Voltage.	V
F18.41 - F18.50	Not Used	-100.0 ~ 100.0	
F18.51	PID Output	In zero servo running status, this function code is used to display present position offset. Range: -0 - 65535.	%
F18.60	Inverter temperature	Temperature of inverter module (it is normal that the temperature is higher than the environment for 40) - 40 ~ 200	°C

7.20 F19 Group: Fault Record Parameter

This group of parameters can be used for viewing the types of the last three faults and the status of inverter at fault, but cannot be operated.

- Function codes related to the information about the last fault:

No.	Function	Range	Unit	Default	Type
F19.00	Last Fault Type	Display the last fault type. See Table 7-22 Fault Types		0	×
F19.01	Output Frequency	Used to display output frequency	Hz	0.00	×

	at Fault	at the last fault.			
F19.02	Output Current at Fault	Used to display output current at the last fault.	A	0.00/0.0	×
F19.03	Bus Voltage at Fault	Used to display bus voltage at the last fault.	V	0	×
F19.04	Running Mode at Fault	Used to display the running status at the last fault. See Table 7-23 Running Modes at Fault		0	×
F19.05	Working Time at Fault	Used to display the working time at the last fault.	h	0	×

- Function codes related to the information about the last fault:

No.	Function	Range	Unit	Default	Type
F19.06	Last Fault Type	Display the last fault type. See Table 7-22 Fault Types.		0	×
F19.07	Output Frequency at Fault	Display output frequency at the last fault.	Hz	0.00	×
F19.08	Output Current at Fault	Display output current at the last fault.	A	0.00/0.0	×
F19.09	Bus Voltage at Fault	Display bus voltage at the last fault.	V	0	×
F19.10	Running Mode at Fault	Used to display the running status at the last fault. See Table 7-23 Running Modes at Fault		0	×
F19.11	Working Time at Fault	Used to display the working time at the last fault.	h	0	×

- Function codes related to the information about the last two faults:

No.	Function	Range	Unit	Default	Type
F19.12	Types of Last Two Faults	Display the types of the last two faults. See Table 7-22 Fault Types		0	×
F19.13	Output Frequency at Fault	Display output frequency at the last two faults.	Hz	0.00	×
F19.14	Output Current at Fault	Display output current at the last two faults.	A	0.00 /0.0	×
F19.15	Bus Voltage at Fault	Display bus voltage values at the last two faults.	V	0	×
F19.16	Running Mode at Fault	Used to display the running status at the last two faults. See Table		0	×

		7-23 Running Modes at Fault.			
F19.17	Working Time at Fault	Used to display the working time at the last two faults.	h	0	×

For various fault types of EM500, see Table 7-22 below:

Table 7-22 Fault Types

Fault type	Keypad display	Fault type	Keypad display
0: No Fault	0	SC: Output Short Circuit Protection	SC
HOC: Instantaneous Overcurrent	HOC	HOU: Instantaneous Overvoltage	HOU
SOC: Stable Overcurrent	SOE	SOU: Stable Overvoltage	SOU
SIU: Stable Undervoltage	SLU	IIP: Input Phase Loss	IIP
OIP: Output Phase Lose	OLP	OI: Inverter Overload	OL
OH: Inverter Overheating Protect	OH	E11: Parameter Setting Conflict	E11
E12: Motor Overheating	E12	E13: Motor Overload	E13
E14: External Fault	E14	E15: Inverter EEPROM Fault	E15
E16: Communication Abnormality	E16	E17: Temperature Sensor Abnormality	E17
E18: Soft Start Relay Off	E18	E19: Current Detection Circuit Abnormality	E19
E20: Stall Fault	E20	E21: PID Feedback Disconnection	E21
E22: Not Used	E22	E25: Motor Overspeed Protection	E23
E24: Parameter Autotuning Abnormality	E24	E25: Not Used	E25
E26: Offload Protection	E26	E27: Accumulated Power-On Time Reach	E27
E28: Accumulated Running time Reach	E28	E29: Internal Communication Fault	E29
E30: Not Used	E30	E31: Not Used	E31
E32: Not Used	E32	E33: CANopen Communication Overtime	E33
E34: DeviceNET without Network Power Supply	E34	E35: DeviceNET BUS-OFF	E35
E36: DeviceNET MACID Detection Failure	E36	E37: DeviceNET IO Communication Overtime	E37

E38: DeviceNET IO Mapping Error	<i>E38</i>	E39: Profibus-DP Parameterization Data Error	<i>E39</i>
E40: Profibus-DP Configuration Data Error	<i>E40</i>	E41: Profibus-DP IO Disconnection	<i>E41</i>
E42: Not Used	E42	E43: Material supply disruptions Error	E43
E44: Winding traverse Error	E44	E45: Air pressure over voltage Error	E45
E46: Air pressure feedback Disconnection	E46	E47: Oil Temperature Over-temperature Error	E47
E48: Oil Temperature Feedback Disconnection	E48	E49: Motor Over-temperature Error	E49
E50: Motor Temperature Feedback Disconnection Error	E50	E51: It's Time To Mechanical Maintenance	E51
E52~E55: Not Used	<i>E52~E55</i>	E56: Pump Error	<i>E56</i>
E57: Pipe networks Overpressure	<i>E57</i>	E58: Pipe networks Undervoltage	<i>E58</i>
E59: water supply tank Water shortage	<i>E59</i>	E60: Not Used	<i>E60</i>
E61: CANSinee Communication Timeout	<i>E61</i>		

For running modes of EM500 at fault, see Table 7-23:

Table 7-23 Running Modes at Fault

Keypad display	Running Mode
0	Not Running
1	Forward Acceleration
2	Reverse Acceleration
3	Forward Deceleration
4	Reverse Deceleration
5	Forward Constant Speed
6	Reverse Constant Speed

7.21 F25 Application of water supply basic groups

Water supply application included F25 / F26 function codes, F25 group is application of

water supply basic groups; F26 group for clock water supply function of the advanced application group.

The optional control mode is:

Mode 1: A direct connection with the inverter's pump + sewage pump + auxiliary pump, In this mode, if the inverter is fault, the system will stop (the setting of inverter fault processing function is invalid).

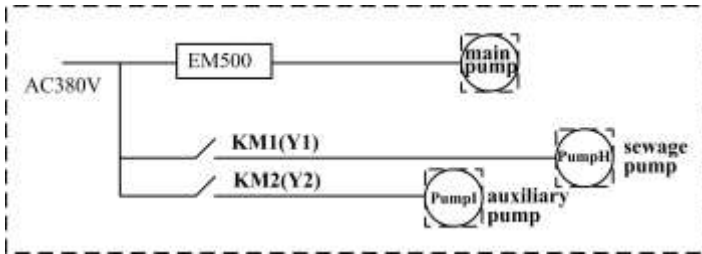

Mode 2: Two pumps connected to the inverter by contactor, one is the Primary pump and the other the standby pump. In this mode, usually only the Primary pump works, if the motor overload occurs, output phase failure, the inverter will report "pump Error", but the system does not stop, the inverter will switch to standby pump to work, so that the water supply is not interrupted (requires the inverter fault handling function code to be set to "maintain the status quo"). a fault also occurs if the standby pump start, the inverter enters the Error state, system is shut down and reports the last error.

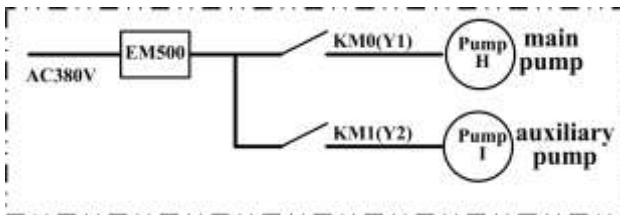

Wiring diagram of water supply application:

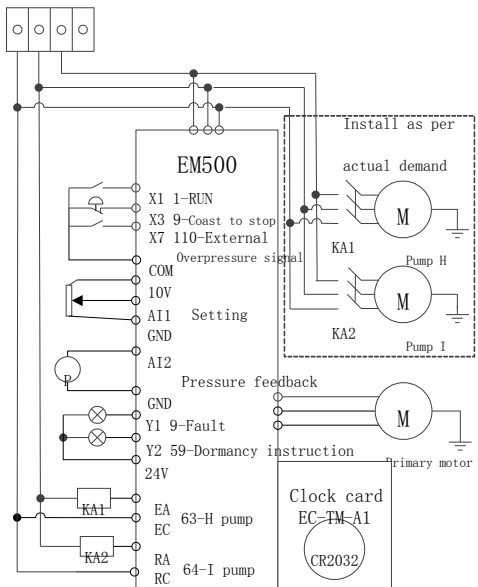

No.	Function	Range	Unit	Default	Type
F25.00	Run Mode Selection	0: The basic mode of constant pressure water supply 1: Not Used		0	○

F25.00=0: The basic mode of constant pressure water supply

Select the basic constant pressure water supply mode, you can restore to basic water supply parameters by manually resetting F12.14 factory defaults.

F25.00=1:Not Used

Function not used.

Function code	Explain	0: Application of Water supply
	After setting F 16.00 = 1, and choose to use mode, restore factory settings. The application parameters are automatically set to the following default values.	
	Basic parameters (motor parameters need to be set manually, conduct static autotuning of motor parameters, and rotation autotuning for synchronous motor is recommended)	

EM500 Open-Loop Vector Control Inverter User Manual

F00. 02	Start/Stop Control	1. Terminal Control
F00. 05	Auxiliary Frequency Source B Options	10: Integral of air compressor PID
F00. 06	Frequency Source Options	1: Auxiliary Frequency Source B
F00. 14	Acceleration Time 1	1. 00s
F00. 15	Deceleration Time 1	1. 00s
F00. 21	Reverse Control	1: Prohibit Reverse
F02. 02	X3	9. Coast to Stop
F02. 05	X6	112: Switch The Pump
F02. 06	X7	110: External Overpressure Signal
F03. 00	Y1	7. Inverter Fault
F03. 01	Y2	59: Dormancy command
F03. 02	R1	63: H Pump Control
F03. 03	R2	64: I Pump Control
F04. 19	Stop Mode	1: Coast-to-Stop
F07. 28	Stall fault detection time	0. 0s
F09. 00	PID Setting Source	1: AI1
F09. 02	PID Feedback Source	2: AI2
F09. 21	PID Setting Variation Time	1. 000s
F16. 12	EC - A card slot expansion card type	1. Clock Card

No.	Function	Range	Unit	Default	Type
F25.02	Upper Limit Pressure	F25.03~F09.03	%	100.0	○
F25.03	Lower Limit	0.1~F25.02	%	0.1	○

F25.02 / F25.03 is used to limit the upper and lower limit of the function code setting

No.	Function	Range	Unit	Default	Type
F25.04	Overpressure alarm pressure of pipe networks	0.1~F09.03	%/MPa	100.0	●
F25.05	Under-voltage alarm pressure of pipe networks	0.1~F09.03	%/MPa	0.1	●
F25.06	Overpressure and under-voltage protection action time	0~3600	s/MPa	500	●

F25.04: Overpressure alarm pressure of pipe networks :

When the feedback pressure exceeds the pipe network over-pressure alarm pressure, and continued until over-voltage protection action time is up, report E57 fault.

F25.05: Under-voltage alarm pressure of pipe networks :

When the feedback pressure is lower than the undervoltage alarm pressure, and until continued over-voltage protection action time is up, report E58 fault.

No.	Function	Range	Unit	Default	Type
F25.16	H Pump Definition	0: No H Pump 1: H Pump is Sewage pump 2: H Pump is primary pump(OnlyF25.00=0)		0	○
F25.17	I Pump Definition	0: No I Pump 1: I Pump is Auxiliary(Sleep) pump 2:I Pump is Emergency pump (Only F25.00=0)		0	○

F25.16=0: No H Pump

It means that H pump has no function .

F25.16=1: H Pump is Sewage pump

The terminal set to H pump is processed according to the treatment logic of the sewage pump. The sewage pump is effective when setting the upper and lower water level input terminals of the sewage tank.

F25.16=2: H Pump is primary pump(OnlyF25.00=0)

The terminal set to H pump must be used in conjunction with I pump set to auxiliary

pump, and set the pump's rotation function to be effective.

F25.17=0: No I Pump

It means that I pump has no function .

F25.17=1: I Pump is Auxiliary(Sleep) pump

The terminal set to I pump will perform the action according to the parameter setting. If the PID reaches the sleep condition, the auxiliary pump will operate when the sleep is valid and not the offline sleep.

F25.17=2: 2:I Pump is Emergency pump (Only F25.00=0)

The terminal set to I pump needs to be used in conjunction with the H pump set as the Primary pump, and the rotation function of the pump after setting is effective.



1. The upper limit level and lower limit level is not set for Inlet pool, it will report E56 fault in running time.
2. When the sewage pump detection function is valid, if the H pump is set as sewage pump, E56 will be reported when running.
3. When sewage pool function is effective, if the upper limit water level of the sewage pool and the lower limit water level of the sewage pool are not set at the same time, E56 failure will be reported when running.
- 4.H Pump refers to the output terminal whose code is set to 63 and I pump corresponds to code 64.

No.	Function	Range	Unit	Default	Type
F25.19	Electromagnetic switch switching time	0.1~5.0	S	0.5	○

The function code applies to the Primary pump and standby pump switch, to solve the electromagnetic switch action delay caused by the problem.

No.	Function	Range	Unit	Default	Type
F25.29	Pump Timing Rotation cycle	0~9999	h	0	●

F25.29 = 0, the pump timing switch function and the pump terminal switch function are invalid.

No.	Function	Range	Unit	Default	Type
F25.30	Rapid pump	0: The normal rotation clock		0	●

	rotation function verification	1: Rotation clock Speed Up			
--	--------------------------------	----------------------------	--	--	--

F25.30=0: The normal rotation clock

It indicates rotation period function code F25.29, the time counting is set in hours.

F25.30=1: Rotation clock Speed Up

It indicates rotation period function code F25.29, the time counting is set in minutes.

No.	Function	Range	Unit	Default	Type
F25.31	The timing pump switch signal output time in advance	0.0~1000.0	S	10.0	●

F25.31 Setting time: the rotation takes place when required or less than F25.31 setting time, the rotation function of pump corresponding to digital output terminal function code 60 will be valid. The terminal function becomes inactive after the pump switch is completed.



1. The pump rotation function is invalid when the backup pump is not set.

No.	Function	Range	Unit	Default	Type
F25.38	Water Supply Pool the water level measuring function	0: Disabled 1: Using switch quantity detection 2: Using analog quantity detection		0	○

F25.38=0: Disabled

Inlet pool water level control function is invalid

F25.38=1: Using switch quantity detection

Inlet pool water level is controlled through the digital input terminal function .

F25.38=2: Using analog quantity detection

Inlet pool water level is controlled by F25.39 ~ F25.42 set value and the corresponding analog input.

No.	Function	Range	Unit	Default	Type
F25.39	The water level signal analog input channel selection	0: AI1 1: AI2 2: AI3 3: AI4 4: HDI 5: Communications input		2	○
F25.40	Upper Limit water level analog level	0.0~100.0	%	60.0	●
F25.41	Lower Limit water level analog level	0.0~100	%	40.0	●
F25.42	Shortage of water water level analog level	0.0~100.0	%	20.0	●

When F25.38 is set to 2, the water level is detected by analog quantity and the analog channel is selected by F25.39.

Water level processing logic:

1. When the upper limit water level, lower limit water level and water level switch are set.

When the water level changes from high to low, the water level is higher than the lower limit of water level, the system operates according to the normal set pressure; when the water level is lower than the lower water level and higher than the water level, the system operates according to abnormal standby pressure; Water level, the system shut down

When the water level changes from low to high, the system will not run when the water level is lower than the lower limit. It will run at normally set pressure.

2. Only when the upper limit water level and the lower limit water level switch are set.

When the water level is lower than the lower water level, the system is in standby. When the water level is higher than the upper limit water level, the system automatically resume operation.

Analog input value into switching states as follows:

Analog input value	upper limit water level switch	lower limit water level switch	shortage water level switch
>F25. 40	closed	closed	closed
>F25. 41 <F25. 40	Open	closed	closed
>F25. 42 <F25. 41	Open	Open	closed
<F25. 42	Open	Open	Open

When the water supply pool function is in effect, the water level given value is adjusted according to the water level.

No.	Function	Range	Unit	Default	Type
F25.43	Non-normal standby pressure	F25.03~F09.01	%/ MPa	0.1	○

The pressure given value for the water level control of the Inlet pool is normally set to a value less than the normal set pressure.

No.	Function	Range	Unit	Default	Type
F25.44	Sewage pool water level detection function	0: Disabled 1: Enabled		0	○

F25.44=0: Disabled

Sewage water level detection function is invalid, sewage pump terminal function output is invalid.

F25.44=1: Enabled

After setting the sewage water terminal secondary function, sewage pool water level detection function effectively, sewage pump terminal function is controlled according to the sewage pool water level.

Sewage pump control logic:

When the sewage pool water level limit signal is valid and the lower limit water level signal is valid, start the sewage pump, when the sewage pool water level lower limit signal is valid, stop the sewage pump.

No.	Function	Range	Unit	Default	Type
F25.45	Inverter fault handling	0:All Stop 1: Maintain the status quo.		0	○

F25.45=0: All Stop

A failure occurs, the normal failure stop

F25.45=1: Maintain the status quo.

This function is available only in master-backup mode.

When the motor overload occurs and the output phase loss fault occurs, the inverter will automatically switch to the currently unused pump. At this time, the inverter will continue to run, and the keypad will display C005 (motor overload in rotation) / C006 (phase loss during rotation) warning.

If another fault occurs, it will stop.

If a fault occurs when switching to an unused pump, the machine stops as a normal fault.

No.	Function	Range	Unit	Default	Type
F25.46	Feedback disconnection handling	0:All Stop 1: Maintain the status quo.		0	○

F25.46=0: All Stop

The system will stop according to the set stop mode, enter the fault state.

F25.46=1: Maintain the status quo.

The system will continue to run at the current output frequency, and the inverter will display C002 warning until it receives the stop command, emergency stop command, external overpressure signal and water shortage signal.

No.	Function	Range	Unit	Default	Type
F25.47	Pipe network overpressure alarm handling	Ones Place: Overpressure alarm selection 0: Error 1: Alarm Tens Place: Switching mode under overpressure 0: Not Used 1: Scram standby		10	○

F25.47 Ones Place=0:

Fault: The inverter enters the overpressure fault condition.

F25.47 One Place=1:

Alarm: Overpressure pipe network is shielded, the system continues to run, the corresponding warning display on the keyboard, while the overpressure alarm output terminal is valid, but does not affect the system to continue running. When the overpressure disappears, the alarm is automatically canceled.

F25.47 Tens Place=1:

Emergency Standby: When overpressure occurs, the inverter output is stopped and enters the standby state. When the pressure returns to the normal pressure range, automatically re-adjust the output, return to normal operation.

No.	Function	Range	Unit	Default	Type
F25.61	Primary pump current running time	0~65535	h		×
F25.62	Primary pump total running time	0~65535	h		●
F25.63	Standby pump current running time	0~65535	h		×
F25.64	Standby pump total running time	0~65535	h		●
F25.61	Primary pump current running time	0~65535	h		×
F25.75	Reset the current running time	0: Not Used 1: Reset		0	○

F25.61 ~ F25.64 record the use of the Primary pump and standby pump time, can be cleared by F25.75 current running time.

7.22 F26 Application of water supply advanced group

This advanced function must be equipped with a clock expansion card to use

No.	Function	Range	Unit	Default	Type
F26.00	The Gregorian calendar year Set	2000~2099		XXX	○
F26.01	The Gregorian calendar Dater Set	01~12(Month). 01~31(Day)		XXX	○
F26.02	The Gregorian calendar Week	0~6 0: Sunday		XXX	○
F26.03	Real time setting	00~23(Hour).00~59(Minutes)		XXX	○

In the Gregorian calendar Dater Set, The first two digits represent the month and the next two represent days

In Real time setting, the first two digits represent hours of the 24-hour clock and the last

two represent minutes

Week with automatic verification, set the date and time automatically calculated and saved to the expansion card

No.	Function	Range	Unit	Default	Type
F26.04	Conventional Time timing choice of water supply	0: Disabled 1: Enabled		0	○

F26.04=0: Disabled

Regular daytime water supply is not enabled

F26.04=1: Enabled

Regular daytime water supply is enabled



1. Conventional date refers Monday through Friday
2. F26.04 = 1, the clock card function is in effect.

No.	Function	Range	Unit	Default	Type
F26.05	T1 Start time	00.00~23.59		0.00	○
F26.06	T1 Start Pressure	F25.03~F25.02	%/ MPa	0.1	○
F26.07	T2 Start time	T1~23.59		0.00	○
F26.08	T2 Start Pressure	F25.03~F25.02	%/ MPa	0.1	○
F26.09	T3 Start time	T2~23.59		0.00	○
F26.10	T3 Start Pressure	F25.03~F25.02	%/ MPa	0.1	○
F26.11	T4 Start time	T3~23.59		0.00	○
F26.12	T4 Start Pressure	F25.03~F25.02	%/ MPa	0.1	○
F26.13	T5 Start time	T4~23.59		0.00	○
F26.14	T5 Start Pressure	F25.03~F25.02	%/ MPa	0.1	○
F26.15	T6 Start time	T5~23.59		0.00	○
F26.16	T6 Start Pressure	F25.03~F25.02	%/ MPa	0.1	○

The above parameters are used to timing multiple preset pressure water supply time and set the corresponding pressure.

Pressure is set to 0, then system is in standby state at the corresponding time.

Set the time period, follow the principle of $T1 \leq T2 \leq T3 \leq T4 \leq T5 \leq T6$. It is recommended to start from T6.

Before T1 time, the pressure is the one in T6 period.

If the start time of a time period is the same as the start time of the previous period, the two sections are combined and the pressure of the latter period is used.

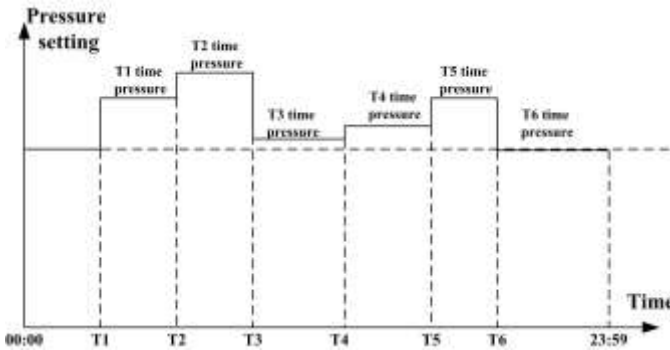

No.	Function	Range	Unit	Default	Type
F26.17	Unconventional Time timing choice of water supply	0: Saturday And Sunday effective 1: Effective on Sunday, Saturday is invalid 2: Saturday and Sunday is invalid		0	○

F26.17=0: Saturday And Sunday effective

Saturday and Sunday timing given by the unconventional date

F26.18=1: Effective on Sunday, Saturday is invalid

Sunday timing is given by the unconventional date, Saturday timing given by the conventional date

F26.19=2: Saturday and Sunday is invalid

Saturday and Sunday timing is given by the conventional date

No.	Function	Range	Unit	Default	Type
F26.18	T1 Start time	00.00~23.59		0.00	○
F26.19	T1 Start Pressure	F25.03~F25.02	%	0.1	○
F26.20	T2 Start time	T1~23.59		0.00	○
F26.21	T2 Start Pressure	F25.03~F25.02	%	0.1	○
F26.22	T3 Start time	T2~23.59		0.00	○

F26.23	T3 Start Pressure	F25.03~F25.02	%	0.1	○
F26.24	T4 Start time	T3~23.59		0.00	○
F26.25	T4 Start Pressure	F25.03~F25.02	%	0.1	○
F26.26	T5 Start time	T4~23.59		0.00	○
F26.27	T5 Start Pressure	F25.03~F25.02	%	0.1	○
F26.28	T6 Start time	T5~23.59		0.00	○
F26.29	T6 Start Pressure	F25.03~F25.02	%	0.1	○

The above parameters are used for multiple preset pressure water supply timing and setting the corresponding pressure (effective on the conventional day).

7.23 F27 Winding rolling application

No.	Function	Range	Unit	Default	Type
F27.00	The application of macro	0: Winding mode 1:Unwinding mode 2:Wire drawing mode 3:Straight wire drawing machine mode		0	○

F27.00=0: Winding mode

This mode can realize the winding function. After the factory setting is restored, the parameters will be reverted to the winding specific parameters

F27.00=1:Unwinding mode

This mode can realize the unwinding function. After the factory setting is restored, the parameters will be reverted to the unwinding specific parameters

F27.00=2:Wire drawing mode

This mode can realize the wire drawing function. After the factory setting is restored, the parameters will be reverted to the wire drawing specific parameters

F27.00=3:Straight wire drawing machine mode

This mode can realize the Straight wire drawing machine mode function. After the factory setting is restored, the parameters will be reverted to the Straight wire drawing machine mode specific parameters

No	Explain	0: Winding mode	1:Unwindin g mode	2:Wire drawing mode	3:Straight wire drawing machine mode
After setting F 16.00 = 3, and choose the macro, restore factory settings. The application parameters are automatically set to the following default values.					

The basic parameters (motor parameters need to be set manually, and do the motor parameters of static autotuning)					
F00.02	Command Source Options	1: Terminal Control	1: Terminal Control	1: Terminal Control	1: Terminal Control
F00.03	Terminal Control Mode Options	0: Terminal RUN for running,	0: Terminal RUN for running,	0: Terminal RUN for running,	0: Terminal RUN for running,
F00.04	Main Frequency Source A Options	1: All given	0: Numeric given	1: All given	1: All given
F00.05	Auxiliary Frequency Source B Options	10: Process PID	10: Process PID		10: Process PID
F00.06	Frequency Source Options	6: Auxiliary Frequency Source B+ Feedforward arithmetic (Winding application)	6: Auxiliary Frequency Source B+ Feedforward arithmetic (Winding application)		6: Auxiliary Frequency Source B+ Feedforward arithmetic (Winding application)
F00.07	Numeric Frequency Setting		75.00Hz		
F00.14	Acceleration Time 1	1.00s	1.00s	70.00s	1.00s
F00.15	Deceleration Time 1	1.00s	1.00s	70.00s	1.00s
F00.16	Maximum Frequency	75.00Hz	75.00Hz	75.00Hz	50.00Hz
F00.18	Upper Limit Frequency	75.00Hz	75.00Hz	75.00Hz	50.00Hz

F00.21	Reverse Control	1: Prohibit Reverse	0: Permit Forward/Reverse	1: Prohibit Reverse	0: Permit Forward/Reverse
F02.00	X1 Terminal	1: Run Terminal "RUN"	1: Run Terminal "RUN"	1: Run Terminal "RUN"	1: Run Terminal "RUN"
F02.01	X2 Terminal	89: Feedforward Reset	89: Feedforward Reset	19: Acceleration/Deceleration Time Terminal 1	2: Direction R/F
F02.02	X3 Terminal	121: External Signals Of Material supply disruptions	121: External Signals Of Material supply disruptions	10: Fault Reset	10: Fault Reset
F02.03	X4 Terminal	10: Fault Reset	10: Fault Reset	4: Forward JOG (FJOG)	26: Frequency Source Switching
F02.04	X5 Terminal				121: External Signals Of Material supply disruptions
F02.05	X6 Terminal	19: Coast to Stop	19: Coast to Stop	19: Coast to Stop	19: Coast to Stop
F02.57	A11 Filter Time	0.05s	0.05s	0.05s	0.05s
F02.58	A12 Filter Time	0.00s	0.00s	0.00s	0.00s
F03.00	Y1 Output	3:FDT1	3:FDT1	3:FDT1	68: Material supply disruptions

					Detection Output
F03.01	Y2 Output			1: Inverter Running (RUN)	
F03.08	Output Status Control at JOG			0b01100: F DT JOG no output	
F04.19	Stop Mode	1:Coast-to-Stop	1:Coast-to-Stop	0:Ramp-To-Stop	1:Coast-to-Stop
F04.20	DC Brake Start Frequency at Stop			2.50Hz	
F04.22	DC Brake Time at Stop	3.00s	3.00s	3.00s	
F04.23	DC Brake Field Weakening Time at Stop	0.00s	0.00s	0.00s	
F05.11	V/F Slip Compensation Gain	0.00%	0.00%	0.00%	
F05.00	V/F Curve Setting				1
F05.02	Multipoint VF Voltage Point V1				3.0%
F05.04	Multipoint VF Voltage Point V2				6.0%
F05.06	Multipoint VF Voltage Point V3				15.0%
F07.11	Current Limit Control				0: Disabled

F15.01	JOG Acceleration Time			8.00s	
F15.02	JOG Deceleration Time			8.00s	
F15.03	Acceleration Time 2			70.00s	
F15.04	Deceleration Time 2			5.00s	
F15.21	Output Frequency Detection Range FDT1	1.00Hz	1.00Hz	2.00Hz	1.00Hz
F15.22	FDT1 Hysteresis	-1.50Hz	-1.50Hz	-1.00Hz	-1.50Hz
F15.23	Output Frequency Detection Range FDT2	1.00Hz	1.00Hz	2.00Hz	1.00Hz
F15.24	FDT2 Hysteresis	-1.50Hz	-1.50Hz	-1.00Hz	-1.50Hz
F15.30	Energy Consumption Brake	1: Enabled	1: Enabled	1: Enabled	1: Enabled
PID Parameters					
F09.01	Numeric PID Setting	5.0	5.0		5.0
F09.02	PID Feedback Source	2: AI2	2: AI2		2: AI2
F09.03	PID Setting Feedback Range	10.0	10.0		10.0
F09.05	Proportional Gain 1	0.06	0.30		0.03
F09.06	Integral Time 1	0.000s	0.000s		4.000s

F09.07	Differential Time 1	30.000ms	30.000ms		30.000ms
F09.08	Proportional Gain 2	0.10	0.40		0.07
F09.09	Integral Time 2	0.000s	0.000s		4.000s
F09.10	Differential Time 2	30.000ms	30.000ms		50.000ms
F09.11	PID Parameter Switching	2: Automatic Switching by Offset	2: Automatic Switching by Offset		2: Automatic Switching by Offset
F09.12	PID Parameter Switching Offset 1	5.00%	0.00%		5.00%
F09.13	PID Parameter Switching Offset 2	45.00%	100.00%		45.00%
F09.16	Upper Limit of PID Output				40.0%
F09.17	Lower Limit of PID Output	-50.0%	-50.0%		-40.0%
F09.19	PID Differential Limit	1.00%	1.00%		0.50%
F09.21	PID Setting Variation Time	2.000s	2.000s		0.500s
F09.35	The Feedback Voltage Upper Limit	9.50V	9.50V		9.50V
F09.36	The Feedback	0.50V	0.50V		0.50V

	Voltage Lower Limit				
F09.37	PID Integral Action Choice Given Change Time				2: when the error is less than F09.38 Start
Feedforward parameters and other settings					
F27.01	Feedforward Gain Effect channel	1: Feedforward Gain *Given source A	2: Feedforward Gain *10V		1: Feedforward Gain *Given source A
F27.02	Feedforward Gain input mode	1: 0.00~Upper Limit feedforward gain	2:- Upper Limit feedforward gain~+ Upper Limit feedforward gain		0:Feedforward gain invariability
F27.04	Upper Limit feedforward gain	500.00%	100.00%		500.00%
F27.05	Feedforward initial gain	50.00%	0.00%		100.00%
F27.13	Soft start incremental	0.60%/s	0.70%/s		
F27.14	feedforward increment 1	0.11%/s	0.18%/s		
F27.15	feedforward increment 2	0.30%/s	0.50%/s		
F27.16	feedforward increment 3	0.75%/s	1.30%/s		
F27.17	feedforward increment 4	1.55%/s	2.75%/s		
F27.18	feedforward	4.00%/s	7.40%/s		

	increment 5				
F27.19	feedforward increment 6	11.00%/s	20.50%/s		
F27.20	Material supply disruptions control way	1201	101	1201	201

Wire drawing machine driven by 2 inverters:

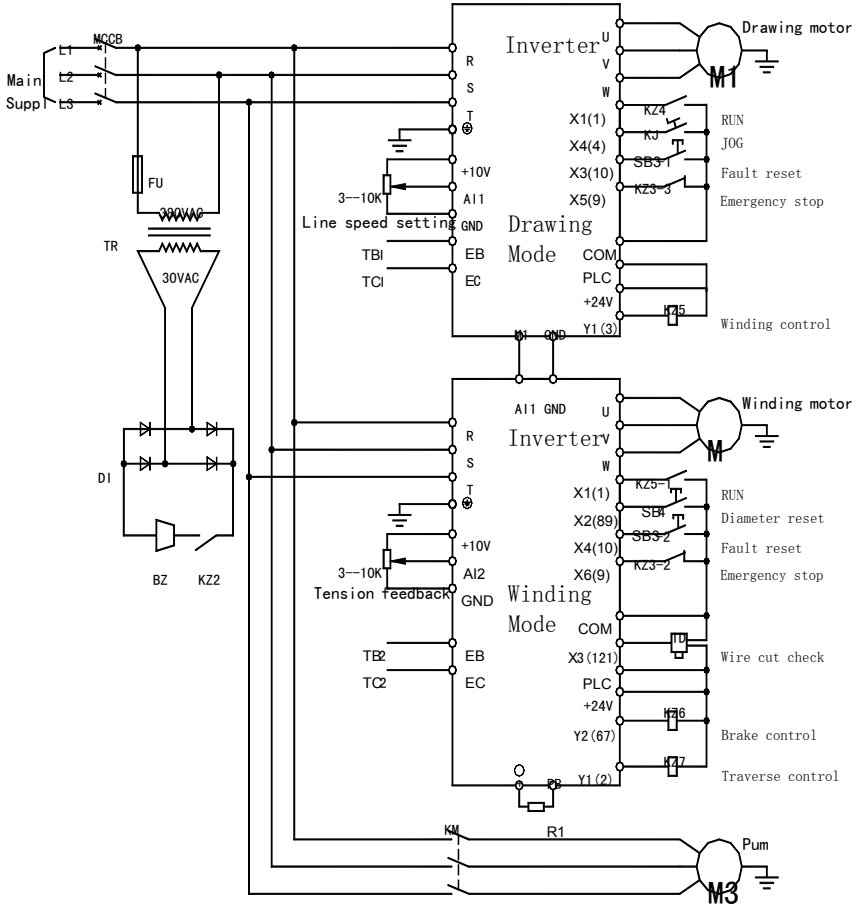

Note:

1. Y2=67 is not set up as defaulted (brake control function). If you need to control brake by the inverter, then you need to set the relative terminal and confirm if codes F27.25~F27.26 are suitable.
2. Unwinding is similar to straight line wire drawing machine, refer to winding/unwinding wiring diagram and the macros.

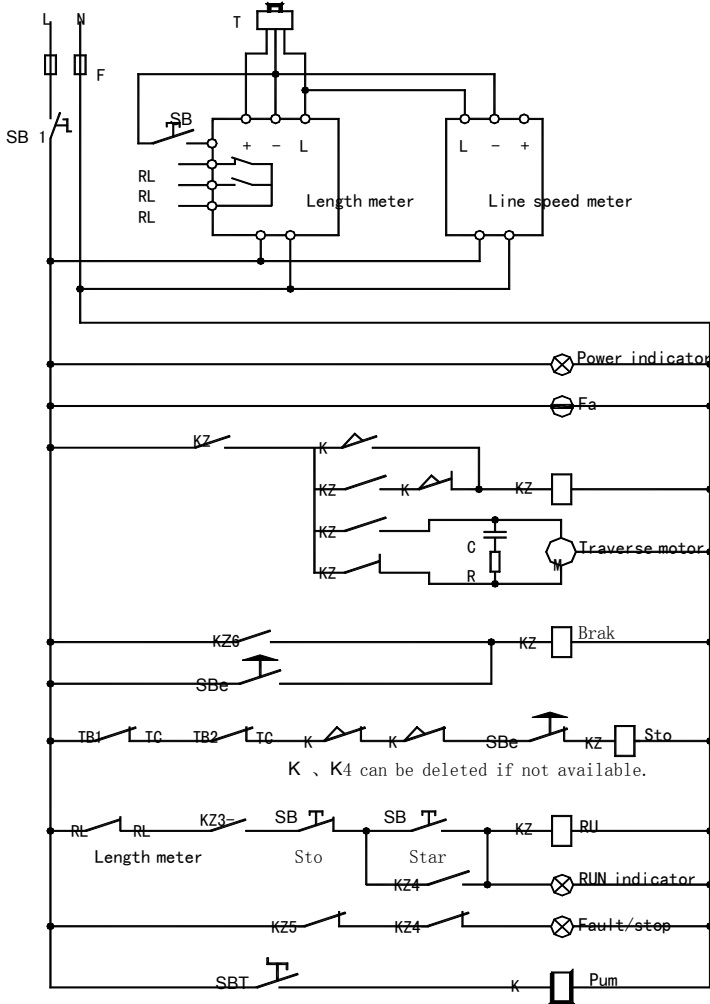

No.	Function	Range	Unit	Default	Type
F27.01	Feedforward Gain Effect channel	0: Feedforward Gain *Given source B 1: Feedforward Gain *Given source A 2: Feedforward Gain *10V		1	○

F27.01=0: Feedforward Gain *Given source B

The feedforward gain acts through given source B.

F27.01=1: Feedforward Gain *Given source A

The feedforward gain acts through given source A

F27.01=2: Feedforward Gain *10V

The feedforward gain is directly multiplied by Fmax superimposed on the output

No.	Function	Range	Unit	Default	Type
F27.02	Feedforward Gain input mode	0:Feedforward gain invariability 1: 0.00~Upper Limit feedforward gain 2: -Upper Limit feedforward gain~+ Upper Limit feedforward gain		1	○

F27.02=0:Feedforward gain invariability

Feedforward gain value is always by F27.05 set value.

F27.02=1: 0.00~Upper Limit feedforward gain

The feedforward gain is automatically adjusted from 0.00 ~F27.04 setting value.

F27.02=2:-Upper Limit feedforward gain~+ Upper Limit feedforward gain

The feedforward gain is automatically adjusted from - F27.04 ~ + F27.04 setting value.



Unlabeled defaults are the same as F27.00 = 0

No.	Function	Range	Unit	Default	Type
F27.03	Feedforward Control	Ones Place:Feedforward reset option 0: Automatic reset 1: Terminal reset Tens Place:Feedforward power		10	○

		outages and parking choice 0: Power outages saved 1: Power outages Unsaved			
--	--	--	--	--	--

F27.03 Ones Place set to 0:

Auto-reset: The feedforward gain is automatically reset when it is stopped

F27.03 Ones Place set to 1:

Terminal reset: The feedforward gain is reset via the terminal

F27.03Tens Place set to 0:

Power-outage saved: Feed-forward gain after Power-outage, power-on can be restored to the value before Power-outage

F27.03 Tens Place set to 1:

Power-outage is not saved: feedforward gain Power-outage, power-up again when the feed-forward gain goes back to the initial gain

No.	Function	Range	Unit	Default	Type
F27.04	Upper Limit feedforward gain	0.00~500.00	%	500.00	○

The feedforward gain upper limit value or the upper limit value of the change

No.	Function	Range	Unit	Default	Type
F27.05	Feedforward initial gain	0.00~500.00	%	50.00	●

The starting value of the feedforward gain

No.	Function	Range	Unit	Default	Type
F27.06	feedforward gain filtering time	0~1000	ms	0	●

Filtering of the feedforward gain, it is generally not required setting.

No.	Function	Range	Unit	Default	Type
F27.07	Feedforward range 0	0.00~ Feedforward range 1	%	4.00	●
F27.08	Feedforward range 1	Feedforward range 1~ Feedforward range 2	%	12.00	●
F27.09	Feedforward range 2	Feedforward range 2~ Feedforward range 3	%	23.00	●
F27.10	Feedforward range 3	Feedforward range 3~ Feedforward range 4	%	37.00	●
F27.11	Feedforward range	Feedforward range 4~	%	52.00	●

	4	Feedforward range 5			
F27.12	Feedforward range 5	Feedforward range 5~100.00	%	72.00	●
F27.13	Soft start incremental	0.00~50.00	%/s	0.60	●
F27.14	feedforward increment 1	0.00~50.00	%/s	0.11	●
F27.15	feedforward increment 2	0.00~50.00	%/s	0.30	●
F27.16	feedforward increment 3	0.00~50.00	%/s	0.75	●
F27.17	feedforward increment 4	0.00~50.00	%/s	1.55	●
F27.18	feedforward increment 5	0.00~50.00	%/s	4.00	●
F27.19	feedforward increment 6	0.00~50.00	%/s	11.00	●

F27.13 Soft start incremental

Correspond to the feedforward change rate in the first time of F09.21 .

F27.07 Feedforward range 0

Correspond to the feedforward change rate on deviation in the range of F27.07 ~ F27.08.

F27.12 Feedforward range 5

Correspond to the feedforward change rate on deviation in the range of F27.12 ~ 100.00%

No.	Function	Range	Unit	Default	Type
F27.20	Material supply disruptions control way	Ones Place:Material supply disruptions detection mode 0: Automatic detection 1: external signal Tens Place:Material supply disruptions detection control 0: Output is greater than the material supply interrupt detection limit detection 1: No detection hundreds place: Material supply disruptions process mode		11211	○

		0:Only Error terminal movement 1:Parking time delay and Error 2:Material supply disruptions Error Thousands place:Brake mode 0:Mode 0 1:Mode 1 myriabit: unwinding reverse mode 0:unrestricted speed 1:According to the F27.24 reverse speed limit			
--	--	--	--	--	--

F27.20 Ones Place=0:

The wire cut is detected by the inverter automatically. This method requires F09.35 and F09.36 to be set correctly.

F27.20 Ones Place=1:

The wire cut is detected by an external proximity switch.

F27.20 Tens Place=0:

When the stop command is received, if the output frequency is less than the setting value of F27.22, no wire cut detection is performed.

F27.20 Tens Place=1:

Wire cut detection is not performed.

F27.20 Hundreds place=0:

After wire cut, press F 27.24 to set the frequency to continue running, only 68 function terminals and fault output terminal action.

F27.20 Hundreds place=1:

After the wire cut, the function terminal and the fault output terminal of No. 68 are actuated, and stop after F27.23 time and F27.24 frequency and enter into the fault state.

F27.20 Hundreds place=2:

After the wire cut, the inverter enters the fault state

F27.20 Thousands place=0:

Mode 0: The brake does not operate when the output frequency is traversed from the top down through the brake output frequency (F27.25).

F27.20 Thousands place=1:

Mode 1: The brake operates when the output frequency is traversed from the top down through the brake output frequency (F27.25).

F27.20 Myriabit=0:

Reverse no speed limit.

F27.20 Myriabit=1:

Reverse press F27.24 speed limit.

No.	Function	Range	Unit	Default	Type
F27.21	Material supply disruptions Detection delay	0.0~10.0	s	6.0	●

After the inverter receives the running command, it will start disconnection detection after the set time.

No.	Function	Range	Unit	Default	Type
F27.22	The lower limit of material supply interruption detection when parking	0.00~60.00	Hz	5.00	●

If the F27.20 tens place is set to 0, the inverter will not perform wire cut detection after it decelerates to this frequency
(The output frequency of the inverter must be lower than this frequency after the soft start time exceeds this frequency and then the function will be effective)

No.	Function	Range	Unit	Default	Type
F27.23	Continue to running time after the material supply disruptions	0.0~60.0	s	10.0	●
F27.24	Continue-to-run Frequency after the material supply disruptions	0.00~Fmax	Hz	5.00	●

The time set in F7.23 starts to count since wire cut is judged. At this time, the running frequency follows the setting of F27.24. For unwinding, it is reverse, for winding, it is forward.

No.	Function	Range	Unit	Default	Type
F27.25	Brake signal output frequency	0.00~Fup	Hz	2.50	●
F27.26	Brake signal duration	0.0~100.0	s	5.0	●

F27.25 and F27.26 are valid only when an output terminal is defined as "brake control" (function code 67), when the inverter output frequency falls from the top to the set value of F27.25, the brake control terminal is valid and maintained (brake mode 1 active).

It becomes invalid after the setting time of F27.26. When the brake control terminal

is active, the inverter will coast to stop.

Run command will not work when the brake control terminal is effective.

If F 27.26 is set to 0.0, the brake control terminal remains active and can be reset by the brake reset terminal or the fault reset terminal.

No.	Function	Range	Unit	Default	Type
F27.27	Traverse detection minimum frequency	0.00~20.00	Hz	10.00	●
F27.28	Traverse signal invalid judge time	0.1~20.0	s	10.0	●
F27.29	Traverse signal effective judge time	0.1~20.0	s	2.0	●

F27.27 ~ F27.29 are valid when an input terminal is set to I22- traverse detection signal.

When the inverter output frequency reaches the set value of F27.27, traverse starts.

If traverse detection terminal is judged as invalid in the time of F27.28, then the traverse switch fails.

If traverse detection terminal is always active during the time of F27.29, then the traverse arm stops.

When the traverse arm is detected faulty, the inverter will report E44 error and coast to stop.

No.	Function	Range	Unit	Default	Type
F27.30	Material supply disruptions Detection of filtering time	1~100	s	5	●

This code is used to set the filter time for material supply disruptions detection, effective for both automatic detection and external detection.

No.	Function	Range	Unit	Default	Type
F27.36	The current feedforward gain value	-500.0~500.0	%	XXX	×

This code is used to check the current feedforward gain

7.24 F28 Air Compressor Application

No.	Function	Range	Unit	Default	Type
F28.00	Application macro	0: Application of air compressor all-in-one macros		0	○

By manually resetting the factory settings, the parameters of the inverter will be restored to the parameters special for the compressor

No	explain	0: Application of air compressor all-in-one macros
Set F 16.00 = 2, and select the macro, restore factory settings. The application parameters are automatically set to the following defaulted values		
The basic parameters (motor parameters need to be set manually, and make static autotuning for the motor parameters)		
F00.02	Command Source Options	2: Communication Control
F00.05	Auxiliary Frequency Source B Options	10: Air compressor integrated PID
F00.06	Frequency Source Options	1: Auxiliary Frequency Source B
F00.17	Upper Limit Frequency Control Options	200.00Hz
F00.18	Upper Limit Frequency	200.00Hz
F00.23	Carrier Frequency	4.0k
F02.03	X4	79: Remote Start
F02.04	X5	23: External Fault Input
F02.05	X6	9: Coast to Stop
F02.37	Minimum Input of Curve 2	2.20V
F03.00	Y1	49: Inlet Valve Control
F03.02	R1	50: Fan Start-stop Control Signals
F03.03	R2	1: Inverter Running (RUN)
F03.21	M1	38: The Fan Speed Output
F06.29	Injection Current at Low Frequency Range	40.0%

Compressor driven by 2 inverters application

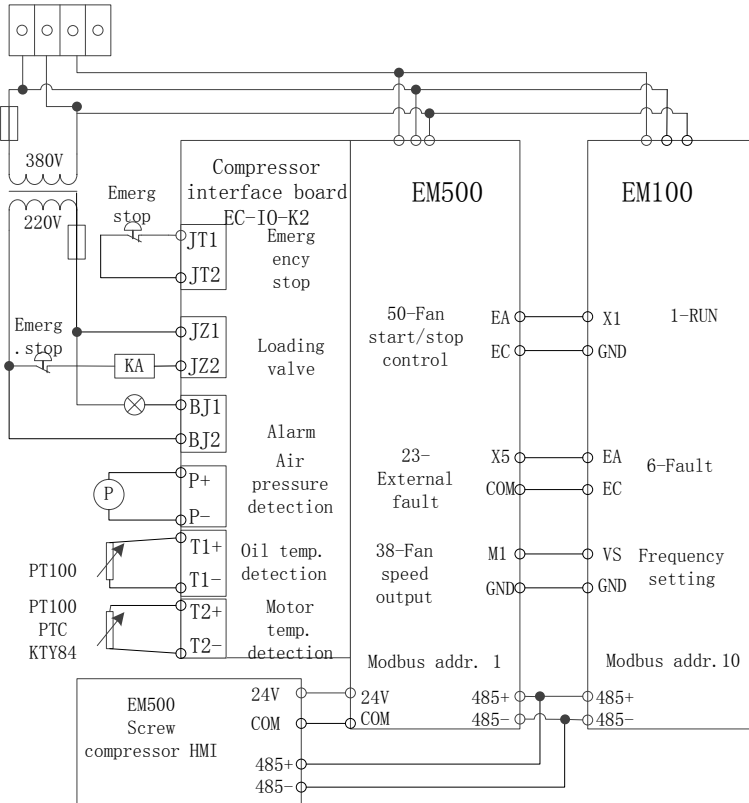

No.	Function	Range	Unit	Default	Type
F28.01	Air compressor start-stop way	0: Local control 1: Remote control		0	○

F28.01=0 Local control:

Remote control function (input terminal function code 79) is invalid, start and stop by local control

F28.01=1 Remote control:

1. Local start remote control is invalid.
2. Remote control for the input terminal function (input function code 79), the system

starts when remote control is engaged, and shut down when disengaged, at this time, local control is invalid

No.	Function	Range	Unit	Default	Type
F28.02	Loading way	0: Automatic 1: Manual		0	○

F28.02=0: Automatic

- 1, When the feedback pressure is less than the lower limit pressure, automatically loaded, when greater than the upper limit pressure, automatically reducing load.
- 2, When the feedback pressure is less than the lower limit pressure, loaded automatically, can not manually unload.
- 3, When the feedback pressure is greater than the upper limit pressure, press loading button, can automatically load the set time in F28.54, after loading, automatically unloaded.
- 4, When the feedback pressure is greater than the pre-warning pressure, the system will be automatically unloaded
- 5, The pressure between the upper and lower limits can be manually loaded and unloaded
- 6, After initial start, automatically loaded

F28.02=1: Manual:

Initial start-up is in unloaded state

After loading, if pressure is greater than the upper limit, the system will be automatically unloaded.

If lower than upper limit pressure, can manually load or unload.

No.	Function	Range	Unit	Default	Type
F28.03	Loading Lower limit Frequency	0.00~Fup	Hz	25.00	●

F 28.03 is the effective minimum frequency for output function code 49

No.	Function	Range	Unit	Default	Type
F28.04	Manual loading control command	0: Clear and unload 1:To 1 Load		0	●



F 28.04 will change as per the present state, clear and unload, for To 1 Load, RAM is effective upon the change.

1. Valve terminal function corresponds to output terminal function code 49

No.	Function	Range	Unit	Default	Type
F28.05	Dormancy Delay	10~7200	s	1200	●

When the inverter remains in unloading state, if the running time reaches at this time, the system will stop automatically.

No.	Function	Range	Unit	Default	Type
F28.06	Unloading operation frequency	0.00~Fup	Hz	20.0	●

The inverter running frequency in unloading state

No.	Function	Range	Unit	Default	Type
F28.07	Shutdown and restart delay time	1~300	s	60	●

When the compressor stops, stops by long wait, and faulty to stop, it needs to wait for this time before receiving start command.

No.	Function	Range	Unit	Default	Type
F28.08	Shutdown delay time	0~60000	s	5	●

If running in the loaded state, the valve will close immediately after receiving the stop command. The system will delay the time of F28.08. When it receives the shutdown command, it will stop directly.

No.	Function	Range	Unit	Default	Type
F28.09	Maximum pressure range	0.5~25.00	MPa	1.60	○
F28.10	Pressure feedback selection	0: AI1 1: AI2 2: AI3 3: AI4 4: HDI		0	○
F28.11	Pressure Digital given	0.00~Upper Limit Pressure value	MPa	0.80	●

F28.10 port corresponds to the gauge's maximum range F28.09.

No.	Function	Range	Unit	Default	Type
F28.12	Early-warning pressure	Pressure Digital setting~ Warning pressure	MPa	0.98	●
F28.13	Warning pressure	Early-warning pressure~ Maximum pressure range	MPa	1.00	●

Early-warning pressure:

When the feedback pressure is greater than the warning pressure, the inverter must perform the unloading

Warning pressure:

When the feedback pressure is greater than the set value, the system will report E45 fault

No.	Function	Range	Unit	Default	Type
F28.14	Pressure proportional gain GP	0.00~100.00		5.00	●
F28.15	Pressure integral time GTi	0.000~60.000, 0.000: No Integral	s	10.000	●
F28.16	Pressure differential time GTd	0.000~60.000	ms	0.000	●
F28.17	Pressure integral action range	0.00~100.00	%	100.00	●
F28.18	Pressure Regulation Upper Limit	0.00~100.00	%	100.00	●
F28.19	Pressure regulation Lower Limit	0.00~100.00	%	25.00	●

Adjust PID control parameters according to the actual application.

F28.18 / F28.19 control upper limit and lower limit of pressure PID output respectively.

No.	Function	Range	Unit	Default	Type
F28.20	lower Limit pressure value	0.00~ Upper Limit pressure value	MPa	0.75	●
F28.21	Upper Limit pressure value	lower Limit pressure value~ Maximum pressure range	MPa	0.85	●

These codes are used for system loading or unloading control and part of parameters limiting. In the meanwhile, these codes are judge condition for loading or unloading, e.g. unloading when greater than the upper limit pressure value, loading when smaller than

the lower limit pressure value.

No.	Function	Range	Unit	Default	Type
F28.22	Pressure limit deviation	0.00~100.00	%	0.00	●

When the absolute value of error is less than this range, the PID function stops. When the feedback reaches at the given value for the first time, the limit deviation starts to act, PID function stops, when beyond the range, the limit deviation fails and the PID restarts to work.

No.	Function	Range	Unit	Default	Type
F28.23	Pressure disconnection detection threshold	0.00~ Maximum pressure range	MPa	0.08	○
F28.24	Pressure disconnection detection Time	0.0~6000.0, 0.0 :The Function is Disabled	s	0.0	●

Disconnection detection value, when the feedback pressure is less than the set value of this function code, the program will start counting, until the time of F28.24 is up, will the system report E46 fault

No.	Function	Range	Unit	Default	Type
F28.25	sensor selection	Ones Place:oil temperature sensor 0: General channel 1: Interface card Tens Place: motor sensor 0: General channel 1: PT100 2: KTY84-130/150 3: PTC130/150 hundreds place: Air pressure sensor 0: General channel 1: Interface card		101	○

Through this function code, you can select oil temperature, motor temperature (supports a variety of sensors) and air pressure sensor. If an interface card is used, temperature sensor can be adopted with PT100 .

As the interface card is detachable, when the air pressure sensor is connected to the

interface cards, the machine assembly becomes more convenient.

No.	Function	Range	Unit	Default	Type
F28.26	Maximum temperature range	60.0~160.0	°C	125.0	○
F28.27	Temperature feedback selection	0: AI1 1: AI2 2: AI3 3: AI4 4: HDI		1	○
F28.28	Temperature Digital given	0.0~ Maximum temperature range	°C	80.0	●

F28.27 Port corresponds to the gauge's maximum range of F28.26

No.	Function	Range	Unit	Default	Type
F28.29	Early-warning Temperature	Temperature Digital setting~ Warning Temperature	°C	105.0	●
F28.30	Warning Temperature	Early-warning Temperature~ Maximum temperature range	°C	110.0	●

Early-warning Temperature:

For storage in case of power failure only, without any function, can be used for upper computer.

Warning Temperature

When the feedback temperature is greater than this temperature, the system will report E47 failure.

No.	Function	Range	Unit	Default	Type
F28.31	Temperature proportional gain GP	0.00~100.00		5.00	●
F28.32	Temperature integral time GTi	0.000~60.000, 0.000: No Integral	s	10.000	●
F28.33	Temperature differential time GTd	0.000~60.000	ms	0.000	●
F28.34	Temperature integral action range	0.00~100.00	%	100.00	●
F28.35	Temperature Regulation Upper	0.00~100.00	%	100.00	●

	Limit				
F28.36	Temperature regulation Lower Limit	0.00~100.00	%	100.00	●

PID control parameters are adjusted as per actual applications.

F28.35 / F28.36 are to control the upper limit and lower limit of temperature PID output respectively.

No.	Function	Range	Unit	Default	Type
F28.37	Fan stop temperature	0.00~ Maximum temperature range	℃	70.0	●
F28.38	Stopping temperature running time	10~7200	s	1200	●
F28.39	Fan start delay time	1~300	s	10	●

When the feedback temperature is higher than the set temperature of F28.28 upon the set time of F28.39, the fan will start operation, namely fan start, output terminal function code is valid.

When the feedback temperature is lower than the set temperature of F28.37 upon the set time of F28.38, the fan will stop, the output terminal function code 50 is valid.

No.	Function	Range	Unit	Default	Type
F28.40	Temperature limit deviation	0.00~100.00	%	0.00	●

When the absolute value of error is less than this range, the PID function stops. When the feedback reaches at the set value for the first time, the limit deviation starts to act, PID function stops, when it is beyond the range, the limit deviation fails and PID restarts.

No.	Function	Range	Unit	Default	Type
F28.41	Temperature disconnection detection threshold	0.0~ Maximum temperature range	℃	8.0	○
F28.42	Temperature disconnection detection Time	0.0~6000.0, 0.0 :The Function is Disabled	s	0.0	●

Disconnection detection value, when the feedback pressure is less than the set value of this function code, the program will start counting, and till the set time of F28-42 is up,

the system will report E48 fault.

No.	Function	Range	Unit	Default	Type
F28.43	Motor Temperature feedback selection	0: AI1 1: AI2 2: AI3 3: AI4 4: HDI		2	○

When F28.25 ten place is 0, the motor temperature can be detected through the analog input channel. The maximum value of the analog input is 200 degrees. The offset of the analog input can be changed when the maximum range of the sensor does not match the value.

No.	Function	Range	Unit	Default	Type
F28.44	Motor overheating threshold	25.0~200.0	℃	110.0	○

When the detected temperature is higher than the value set in F 28.44, the inverter will report E49 fault. After the fault, the temperature needs to be less than F28.44 set temperature -25 degree to run normally again.

No.	Function	Range	Unit	Default	Type
F28.45	Motor PTC disconnection detection threshold	0.0~50.0	℃	8.0	○
F28.46	Motor PTC disconnection detection Time	0.00~6000.0, 0.0:The Function is Disabled	s	0.0	●

When the inverter display temperature is less than the value of F28.45 and maintain F28.64 set time, the inverter reported E50 failure

No.	Function	Range	Unit	Default	Type
F28.47	Oil filter using time preset	0~9000	h	4500	●
F28.48	oil separator using time preset	0~9000	h	4500	●
F28.49	Air filter using time preset	0~9000	h	4500	●
F28.50	Lubricating oil using time preset	0~9000	h	4500	●
F28.51	Grease using time	0~9000	h	4500	●

	preset				
F28.52	Preset alarm delay time	0~100	h	10	●

Used to set the corresponding time, the inverter will record the actual operation time, when the use of time is beyond the alarm delay time, E51 failure occurs.

No.	Function	Range	Unit	Default	Type
F28.53	The Power meter timing reset	0: No Used 1: Reset		0	●

F28.53=0: Not Used

Indicates no operation

F28.53=1: Reset

After setting the code, the running time and the current power is cleared, after that, it is cleared automatically.

No.	Function	Range	Unit	Default	Type
F28.54	Inching loading delay	0~60	s	3	○

This function code setting time is when the inverter meets the unloading condition, manually loading, the loading valve will open and then automatically shut down when the set time of F28.54 is up, if the pressure is greater than the warning pressure before the set time is up, the valve will shut down in advance.

No.	Function	Range	Unit	Default	Type
F28.55	Protection block	First place: mechanical maintenance time is up Second place: Pressure overrun protection Third place: Pressure feedback wire cut protection Fourth place: Temperature overrun protection Fifth place: Temperature feedback wire cut protection Sixth place: Not Used Seventh place: The motor feedback wire cut protection Eighth place: Not Used From right to left (0- No shield 1-shield)		0000 0001	○

After setting, can be used to block the corresponding fault

No.	Function	Range	Unit	Default	Type
F28.66	JZ Multi-function set	See the output terminals function table		49	○
F28.67	BJ Multi-function set	See the output terminals function table		7	○

F28.66 and F28.67 are used to set the function of the JZ / BJ terminal on the interface card (ie the two terminals can be used for other purposes)

No.	Function	Range	Unit	Default	Type
F28.68	Interface card Positive and negative logic setting	0: JT Normally closed 1: JT Normally open		0	○

F28.68=0: JT Normally closed

At this point the air compressor interface card JT terminal logic is as follows: JT1 and JT2 short cut then emergency stop is invalid, disconnect and the emergency stop is valid, and the inverter will coast to stop

F28.68=1: JT Normally open

At this point the air compressor interface card JT terminal logic is as follows: JT1 and JT2 short cut and emergency stop is valid, and the inverter will coast to stop, disconnect and the emergency stop is invalid.

No.	Function	Range	Unit	Default	Type
F28.69	Sensor offset curve setting	Ones Place: Interface board oil temperature 0: Curve 1 1: Curve 2 2: Curve 3 3: Curve 4 Tens Place: Interface board Motor temperature 0: Curve 1 1: Curve 2 2: Curve 3 3: Curve 4 hundreds place: Interface board pressure		120	○

		0: Curve 1 1: Curve 2 2: Curve 3 3: Curve 4			
--	--	--	--	--	--

No.	Function	Range	Unit	Default	Type
F28.70	Loading and unloading state	0: Unloading state 1: Loading status 2: Dormant state		0	×

It is used to check the working state of the current inverter

No.	Function	Range	Unit	Default	Type
F28.71	Time Error query	First place: Oil filter time Second place: Oil separator time Third place: Air filter time Fourth place: Lubricating oil time Fifth place: Grease time From right to left		00000	×

After E51 fault occurs, you can check which mechanical part's maintenance time is up that it leads to the failure.

No.	Function	Range	Unit	Default	Type
F28.72	Stop delay remaining time	0~60000	s	XXX	×
F28.73	Continuous no-load running time	0~60000	s	XXX	×
F28.74	Stop and restart remaining time	0~60000	s	XXX	×

Used to view the frequency of start-up and stop delay time, can be displayed on the upper computer.

No.	Function	Range	Unit	Default	Type
F28.75	The electricity meter: MWh	0~65535	Mwh	XXX	×
F28.76	The electricity meter: KWh	0~65535	KWh	XXX	×

This function code is used to record the power consumption, not saved in case of power outage.

No.	Function	Range	Unit	Default	Type
F28.77	The Running Time	0~60000	h	XXX	×

This function code is used to display the running time, not save in case of power outage.

No.	Function	Range	Unit	Default	Type
F28.78	Pressure feedback	0.00~600.00	MPa	0	×
F28.79	oil passage temperature feedback	0.0~200.0	℃	0	×
F28.80	Motor temperature feedback	0.0~200.0	℃	0	×

This function code is used to display the physical value detected by the three sensors.

No.	Function	Range	Unit	Default	Type
F28.81	Oil filter actual using time	0~9500	h	XXX	●
F28.82	Oil separator actual using time	0~9500	h	XXX	●
F28.83	Air filter actual using time	0~9500	h	XXX	●
F28.84	Lubricating oil actual using time	0~9500	h	XXX	●
F28.85	Grease actual using time	0~9500	h	XXX	●

Used to display the actual using time of each component.

No.	Function	Range	Unit	Default	Type
F28.86	Loading running time	0~65535	h	XXX	●
F28.87	unloading running time	0~65535	h	XXX	●

Used to display the cumulative loading and unloading ratio.

No.	Function	Range	Unit	Default	Type
F28.88	The cumulative power meter: MWh	0~65535	MWh	XXX	●
F28.89	The cumulative power meter: KWh	0.0~999.9	KWh	XXX	●

Used to display the cumulative power consumption, saved in case of power outage.

No.	Function	Range	Unit	Default	Type
F28.90	Cumulative operation time	0~60000	h	XXX	●

Used to check the cumulative running time.

No.	Function	Range						Unit	Default	Type
		7	6	5	4	3	2			
F28.91	Interface card Terminal function query	*	*	*	*	*	B J	JZ	XXX	×
		0: Disabled 1: Abled JT: Display emergency stop state JZ: Display JZ terminal state of Interface card BJ: Display BJ terminal state of Interface card								

Used to display the operating state of input and output terminal on the interface card, JT is set to 1 when the digital terminal of coast to stop is effective.

No.	Function	Range	Unit	Default	Type
F28.92	Air pressure Input monitoring	-10000~10000		XXX	×
F28.93	Oil temperature input monitoring	-10000~10000		XXX	×
F28.94	Motor temperature input monitoring	-10000~10000		XXX	×

Used to display the input value of 3 analog channels on the interface card for easy debugging. The displayed value is that after the offset.

8. Motor Parameter Autotuning

8.1 Motor Parameter Autotuning

When inverter is in vector control mode, motor parameter autotuning is required. However, if not, parameter autotuning is also suggested for acquiring higher control precision at initial operation.

It's not easy for user to obtain motor parameters required for the arithmetic at vector control. EM500 provides the function of motor parameter autotuning. After the function is enabled, inverter autotunes the relevant parameters of motor connected and saves them to the internal memory. For definitions of motor parameters, please refer to Figure 8-1 for specific meanings of 3-phase induction motor.

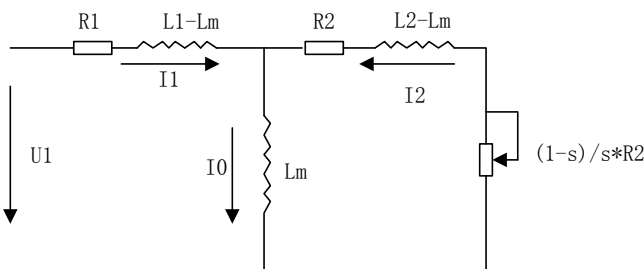

Figure 8-1 Equivalent Circuit of 3-Phase Induction Motor

In the figure, meanings of R_1 , R_2 , L_1 , L_2 , L_m and I_0 : Stator resistor, rotor resistor, stator inductance, rotor inductance, stator & rotor mutual inductance, and idling excitation current respectively; leakage inductance $L_s = L - L_m$.

8.2 Precautions Before Autotuning

- Autotuning is a process of autotuning motor parameters. EM500 can autotune motor parameters in 2 modes: stationary autotuning and rotational autotuning.
 - Stationary autotuning is applied to the occasions when motor can not be disconnected from load, but inverter can obtain motor parameters.

- Rotational autotuning is applied to the occasions when motor can be disconnected from load. Before autotuning, motor should be disconnected from load. Never perform rotational autotuning for a motor with load.
- Make sure that motor is in stop status before autotuning; otherwise, autotuning can not be performed normally.
- Autotuning is only enabled when inverter is in keypad control mode (F00.02=0).
- To ensure normal autotuning, set all motor parameters as per the values listed on motor nameplate correctly: F01.00: Motor model, F01.01: Motor rated power, F01.02: Motor rated voltage, F01.03: Motor rated current, F01.04: Motor rated frequency, F01.05: Motor rated speed, F01.06: Motor wiring method and F01.07: Motor rated power factor. Based on the rated power of inverter, match inverter with an applicable Y-series motor, and the defaults of motor can meet most of needs.
- To ensure the control performance, motor and inverter should match in terms of the power rating. Usually, power rating of motor is only allowed to be one level lower than that of inverter.
- After autotuning finishes normally, the setting value of F01.09 - F01.13, F01.19 – F01.22 will be updated and auto-saved.
- When F12.14=1 reset the default, the parameters of F01.00 - F01.13, F01.19 – F01.22 remain unchanged.

8.3 Steps of Autotuning





- In parameter setting status, set F00.2=0, and disconnect motor from load.
- Set all motor parameters as per the values listed on the nameplate correctly: F01.00: Motor model, F01.01: Motor rated power, F01.02: Motor rated voltage, F01.03: Motor rated current, F01.04: Motor rated frequency, F01.05: Motor rated speed, F01.06: Motor wiring method and F01.07: Motor rated power factor.

For asynchronous induction motor

- By setting F01.34=1, and pressing , inverter starts stationary autotuning for motor. Or by setting F01.34=2, and pressing , inverter starts rotational

autotuning for motor.

For permanent-magnet synchronous motor

- By setting F01.34=11, and pressing , inverter starts stationary autotuning for motor. Or by setting F01.34=12, and pressing , inverter starts rotational It takes about 2 minutes to complete the autotuning and, afterwards, keypad returns to the initial power-on status.
- By pressing  in autotuning, it will display “E24” parameter autotuning abnormality. By pressing , inverter will return to parameter setting status. If autotuning fails, inverter will display “E24” parameter autotuning abnormality. By pressing , inverter will return to parameter setting status.

9. Troubleshooting

9.1 Faults

When something abnormal happens to inverter, keypad will display corresponding fault code and parameter; the fault relay is on, the fault output terminal is on, inverter output stops. If motor is still running when a fault occurs, it will stop by the setting mode. For EM500 faults and countermeasures, see Table 9-1.

Table 9-1 EM500 Faults and Troubleshooting

Fault Code	Fault type	Cause	Troubleshooting
<i>SC</i>	Short Circuit/EMC Fault	<ol style="list-style-type: none"> 1. Short circuit between output phase and ground 2. Short circuit between phases 3. Short circuit of external brake resistor 4. Acceleration/deceleration time is too short 5. Power module is damaged 6. Field interference 	<ol style="list-style-type: none"> 1. Check if there is any short circuit phenomenon. 2. Extend acceleration/ deceleration time 3. Investigate causes and reset after taking appropriate measures. 4. Seek for technical support.
<i>HOC</i>	Instantaneous Overcurrent	<ol style="list-style-type: none"> 1. Short circuit between inverter output phases 2. Acceleration/deceleration time is too short. 3. Under V/F control mode, V/F curve has been set irrationally. 	<ol style="list-style-type: none"> 1. Check if there is any short circuit phenomenon in wiring. 2. Extend acceleration/ deceleration time. 3. Set VF curve rationally.
<i>SOC</i>	Stable Overcurrent	<ol style="list-style-type: none"> 4. Motor is running when inverter starts. 5. Motor exceeds inverter capacity or load is too heavy. 6. IGBT damaged (HOC). 	<ol style="list-style-type: none"> 4. Enable the revolution track or start DC brake. 5. Replace with an appropriate motor or inverter.
<i>HOV</i>	Instantaneous Overvoltage	<ol style="list-style-type: none"> 1. Deceleration time is too short and regenerated energy is too large. 2. Input voltage is too high. 	<ol style="list-style-type: none"> 1. Extend deceleration time. 2. Select an appropriate braking unit/braking resistor.

			3. Lower the input voltage to the specified range.
<i>SOU</i>	Stable Overvoltage	<ol style="list-style-type: none"> 1. Power grid voltage is too high. 2. Deceleration time is too short. 	<ol style="list-style-type: none"> 1. Lower the voltage to the specified range. 2. Extend deceleration time
<i>SLU</i>	Stable Undervoltage	<ol style="list-style-type: none"> 1. Input voltage phase loss. 2. Wiring terminals of input voltage are loosened. 3. Input voltage drops too much. 4. Aging of switch contact on input power supply. 	<ol style="list-style-type: none"> 1. Check the input voltage and its wiring. 2. Tighten screws of input wiring terminal. 3. Check air switch and contactor.
<i>ILP</i>	Input Phase Loss	<ol style="list-style-type: none"> 1. Input voltage phase loss (rated power). 	<ol style="list-style-type: none"> 1. Check input voltage. 2. Check input voltage wiring. 3. Check whether the connection terminals are loosened.
<i>OLP</i>	Output Phase Loss	<ol style="list-style-type: none"> 1. Phase loss of U, V or W 	<ol style="list-style-type: none"> 1. Check the connection between inverter and motor. 2. Check whether motor winding is disconnected; 3. Check whether output terminals are loosened.
<i>OL</i>	Inverter Overload	<ol style="list-style-type: none"> 1. Acceleration/deceleration time is too short. 2. Under V/F control mode, V/F curve has been set irrationally. 3. Load is too heavy. 4. Braking time is too long; Repeated dc brake 	<ol style="list-style-type: none"> 1. Extend acceleration/deceleration time. 2. Set VF curve rationally. 3. Replace inverter with another one that matches with the load. 4. Reduce braking time; Do not repeatedly dc brake
<i>OH</i>	Radiator overheating	<ol style="list-style-type: none"> 1. Ambient temperature is too high. 2. Inverter is in poor ventilation. 3. Cooling fan fault. 	<ol style="list-style-type: none"> 1. Running conditions of inverter shall comply with specification requirements. 2. Improve ventilation environment and check whether air duct is blocked. 3. Replace the cooling fan.

<i>E 11</i>	Parameter Setting Conflict	1. Parameter setting logic conflict	1. Check whether parameters set prior to a fault is unreasonable.
<i>E 12</i>	Motor Overload	1. Detection of motor temperature is greater than the threshold 2. Motor temperature sensor is broken. 3. Ambient temperature is too high 4. The load is too heavy	1. Check motor temperature threshold. 2. Check motor temperature sensor 3. Improve heat dissipation of the motor 4. Choose the proper motor
<i>E 13</i>	Motor Overload	1. Acceleration/deceleration time is too short. 2. Under V/F control mode, V/F curve has been set irrationally. 3. Load is too heavy.	1. Extend acceleration/deceleration time. 2. Set VF curve rationally. 3. Replace inverter with another one that matches with the load.
<i>E 14</i>	External Fault	1. Peripheral fault terminal acts.	1. Check peripherals.
<i>E 15</i>	Inverter EEPROM Fault	1. Interference results in reading and writing errors of EEPROM. 2. EEPROM damaged.	1. Press STOP/RESET to reset and then try it again. 2. Seek for technical support.
<i>E 16</i>	Communication Abnormality	1. the communication timeout is enabled for discontinuous communication system 2. SCI communication failure	1. Set F10.03 to 0.0 for discontinuous communication system 2. Check whether the communication cable is disconnected. 3. Adjust the communication overtime (F10.03).
<i>E 17</i>	Inverter Temperature Sensor Abnormality	1. Temperature sensor of inverter is off or short-circuited.	1. Check whether temperature sensor of inverter is properly wired. 2. Seek for technical support
<i>E 18</i>	Soft Start Relay Off	1. The grid is interrupted 2. Input voltage phase loss. 3. Wiring terminals of input voltage are loosened.	1. interruption of power supply should be done after the inverter stopped

		<ol style="list-style-type: none"> 4. Input voltage drops too much. 5. Aging of switch contact on input power supply. 	<ol style="list-style-type: none"> 2. Check the input voltage and its wiring. 3. Tighten screws of input wiring terminal. 4. Check air switch and contactor.
<i>E19</i>	Current Detection Circuit Abnormality	<ol style="list-style-type: none"> 1. Detection circuit of drive board or control board is damaged. 	<ol style="list-style-type: none"> 1. Seek for technical support.
<i>E20</i>	Stall Fault	<ol style="list-style-type: none"> 1. The set deceleration time is excessively short; 2. Energy consumption brake abnormality at ramp-to-stop. 	<ol style="list-style-type: none"> 1. Increase the set deceleration time. 2. Check energy consumption brake status.
<i>E21</i>	PID Feedback Disconnection	<ol style="list-style-type: none"> 1. PID feedback is higher than upper limit F09.24 or lower than lower limit F09.25, depending upon types of sensors. 	<ol style="list-style-type: none"> 1. Check whether the feedback line falls off; 2. Check whether the sensor works abnormally; 3. Adjust the feedback disconnection detection value to a reasonable level.
<i>E22</i>	Not Used		
<i>E23</i>	Keypad EEPROM Fault	<ol style="list-style-type: none"> 1. Interference results in reading and writing errors of the EEPROM. 2. EEPROM damaged. 	<ol style="list-style-type: none"> 1. Press STOP/RESET to reset and then try it again. 2. Seek for technical support.
<i>E24</i>	Autotuning Abnormality	<ol style="list-style-type: none"> 1. Press STOP/RESET in the parameter autotuning. 2. In autotuning, the external coast-to-stop terminal FRS=ON. 3. Motor is not connected to output terminal of inverter. 4. Motor is not disconnected from load for rotational autotuning. 5. Motor fault. 	<ol style="list-style-type: none"> 1. Press STOP/RESET to reset. 2. Check the connection between inverter and motor. 3. Motor is disconnected from load for rotational autotuning. 4. Check motor.
<i>E25</i>	Not Used		
<i>E26</i>	Offload	<ol style="list-style-type: none"> 1. Enabled when motor 	<ol style="list-style-type: none"> 1. The load is excessively light

	Protection	current is lower than offload detection level F07.22 and this status is maintained for the time set through F07.23 2. Current detection module is damaged	or the offload level is not reasonable; 2. Offload; 3. Current detection module is damaged 4. Seek for technical support
<i>E27</i>	Accumulated Power-On Time is up	It is time for maintenance	1. Contact dealer.
<i>E28</i>	Accumulated Running time is up	It is time for maintenance	1. Contact dealer.
<i>E29</i>	Internal Communication Fault	1. Internal SPI communication fault	1. Power-on after power cut. 2. Seek for technical support.
<i>E30</i> - <i>E32</i>	Not used		
<i>E33</i>	CANopen Communication Overtime	1. Data Communication Overtime	1. Ensure that inverter is powered on again after the line is smooth.
<i>E34</i>	DeviceNet without Network Power Supply	1. No DC24V Power Supply is detected for DeviceNET bus	1. Power supply backs to normal
<i>E35</i>	DeviceNet BUS-OFF	1. Short circuit between CAN_H and CAN_L of DeviceNet bus	1. Ensure that wiring is normally
<i>E36</i>	DeviceNet MACID Detection Error	1. There is already the same station on the bus	1. Power on inverter after address modification
<i>E37</i>	DeviceNet IO Communication Overtime	1. NO IO message received within specified time during online status	1. Ensure that inverter is powered on again after the line is smooth.
<i>E38</i>	DeviceNet IO Mapping Error	1. Non-existence of IO Polling Data Address	1. Make sure to input a correct parameter address
<i>E39</i>	Profibus-DP	1. Incompliance of	1. Make sure to receive correct

	Parameterization Data Error	parameterization data sent by master with specification	parameterization data
<i>E40</i>	Profibus-DP Configuration Data Error	1. The configuration data sent by master is not supported by slave card	1. Make sure to receive correct configuration data
<i>E41</i>	Profibus-DP IO Disconnection	1. At normal data exchange status, DP card has not received any data for a long time (disconnection between DP card and master), so it exists data exchange status.	1. Enter data exchange status restoration fault
<i>E42</i>	Not Used		
<i>E43</i>	Material supply disruptions Error	1. When the external signal is detected, the external signal terminal is closed. 2. In automatic detection, the feedback is greater than the voltage limit or feedback is less than the voltage lower limit.	1. Reduce starting feed forward and soft start feedforward gain when starting disconnection. 2. The shock disconnection in operation, Increase or decrease the ratio P. 3. Check whether the sensor is loose lead.
<i>E44</i>	Winding traverse Error	1. The cable detection terminal valid time is too long. 2. Cable detection terminal invalid time is too long.	1. Check if the sensor is working properly. 2. Check whether the terminal can be judged normally closed.
<i>E45</i>	Air pressure over voltage Error	1. The sensor feedback pressure is too high. 2. The analog input terminals are damaged	1. Check the sensor for abnormalities. 2. Check whether the analog terminals can detect the analog input normally. 3. Check the external devices.
<i>E46</i>	Air pressure feedback	1. The sensor feedback pressure is too low.	1. Check the sensor for abnormalities.

	Disconnection	2. The analog input terminals are damaged	2. Check whether the analog terminals can detect the analog input normally. 3. Check the external devices.
E47	Oil Temperature Over-temperature Error	1. When an expansion card is used, the PT100 is disconnected or the line is disconnected. 2. When using an external sensor, the sensor is damaged or the analog input terminal is damaged	1. Check the sensor for abnormalities. 2. Check whether the analog terminals can detect the analog input normally. 3. Check the external devices.
E48	Oil Temperature Feedback Disconnection	1. The sensor is abnormal. 2. Input terminal is damaged.	1. Check the sensor for abnormalities. 2. Check whether the analog terminals can detect the analog input normally. 3. Check the external devices.
E49	Motor Over-temperature Error	1. When an expansion card is used, the PT100 is disconnected or the line is disconnected. 2. When using an external sensor, the sensor is damaged or the analog input terminal is damaged. 3. The temperature does not fall below the fault temperature of 25 degrees.	1. Check the sensor for abnormalities. 2. Check whether the analog terminals can detect the analog input normally. 3. Check the external devices. 4. The temperature dropped to -25 degrees below F28.44 setpoint temperature after fault .
E50	Motor Temperature Feedback Disconnection Error	1. The sensor is abnormal. 2. Input terminal is damaged.	1. Check the sensor for abnormalities. 2. Check whether the analog terminals can detect the analog input normally.

			3. Check the external devices.
<i>E51</i>	It's Time For Mechanical Maintenance	1. F28.81 ~ F28.85 record time is greater than F28.47 ~ F28.51 plus F28.52 time, that means the maintenance time is up.	1. Timely maintenance of mechanical equipment and then manually F28.81 ~ F28.85 for zero treatment.
<i>E52</i>	Not Used		
<i>E56</i>	Pump Error	1. occurs only when the water supply is in standby mode, plus the Primary pump mode, which drives a pump motor overload output phase fault.	1. Check if the load is too heavy. 2. Check if the output line is loose
<i>E57</i>	Pipe networks Overpressure	1. Feedback pressure in water supply applications is too high.	1. Check the sensor for abnormalities. 2. Check whether the analog terminals can detect the analog input normally. 3. Check the external devices.
<i>E58</i>	Pipe networks Undervoltage	1. The feedback pressure in water supply applications is small.	1. Check the sensor for abnormalities. 2. Check whether the analog terminals can detect the analog input normally. 3. Check the external devices.
<i>E59</i>	water supply tank Water shortage	1. The sensor is abnormal.	1. Check the sensor for abnormalities.
<i>E60</i>	Not Used		
<i>E61</i>	CANSine Communication Timeout	1. Data communication timeout	1. Make sure that the line is unblocked and power on again.

When inverter has any fault above, press  to reset or use the fault reset terminal to exit the fault status; after the fault is cleared, inverter returns to the function setting status; if the fault fails to be cleared, LED will continue to display present fault data.

Check List of Capitalized English Letters Displayed:

<i>A</i>	<i>B</i>	<i>C</i>	<i>d</i>	<i>E</i>	<i>F</i>	<i>G</i>	<i>H</i>	<i>I</i>	<i>L</i>
A	B	C	D	E	F	G	H	I	L

<i>n</i>	<i>O</i>	<i>P</i>	<i>q</i>	<i>r</i>	<i>S</i>	<i>t</i>	<i>U</i>	<i>ll</i>	<i>y</i>
N	O	P	Q	R	S	T	U	X	Y

Check List of Figures Displayed:

<i>1</i>	<i>2</i>	<i>3</i>	<i>4</i>	<i>5</i>	<i>6</i>	<i>7</i>	<i>8</i>	<i>9</i>	<i>0</i>
1	2	3	4	5	6	7	8	9	0

9.2 Warning Analysis

When the inverter is abnormal, but it is not allowed to stop, LED display will display the corresponding warning code. The warning occurs and the inverter will perform the corresponding action according to the parameters, and it should deal with security issues as quickly as possible and then stop and check the warning's reason.

Such as "C002" will be displayed flashes when there is a warning. Press to stop the flashes and you can modify the parameters. There is still a warning. The keyboard is not operated within 5s occur warning again if you stop the flashes.

Warning Code	Warning Types	Warning Causes	Warning measures
<i>C001</i>	Not Used		

<i>C002</i>	The pump feedback is disconnected	Available only in water supply applications 1. This warning is displayed when the feedback disconnection method is selected to maintain the current status and the disconnection condition is satisfied.	1. Check whether the sensor is abnormal 2. Check if the analog input terminals are abnormal
<i>C003</i>	Pipe network overpressure	Available only in water supply applications 1. This warning is displayed when the pressure of the water supply pipe network is too high and the overpressure treatment mode is selected as no alarm.	1. Check if the sensor is abnormal 2. Check if the analog input terminals are damaged
<i>C004</i>	Water supply pool water shortage	Available only in water supply applications 1. If the water supply level control function is enabled, if the water level input terminal is included, this warning is displayed if the water level input terminal is disconnected after the inverter is running.	1. Check if the input terminals corresponding to the water level are damaged
<i>C005</i>	Motor overload during rotation	Available only in water supply applications 1. The frequency converter displays this warning when a water supply application is in the switching mode of the Primary pump plus standby pump and the motor is overloaded when one of the pumps is driven.	1. Check if the load is too heavy
<i>C006</i>	Output phase loss during rotation	Available only in water supply applications 1. The frequency converter displays this warning when a water supply application is in the switching mode of the Primary pump plus standby pump and an output phase loss occurs while driving one of the pumps.	1. Check whether the output wiring is loose

9.3 Fault Analysis

After power is on, due to improper function setting and incorrect wiring between inverter and external control terminals, motor cannot meet the expected working requirements. Fault analysis as described in this chapter can be taken as the reference to take the corrective actions. If trip codes appear, see 9.1 for the corrective actions to clear the trips.

9.3.1 Parameters Unavailable for Setting

- Clockwise or counter clockwise of potentiometer the parameter display remains unchanged.

Some parameters can only be edited when inverter stops.

- Clockwise or counter clockwise of potentiometer, the parameter display changed, but they cannot be saved.

Some parameters cannot be edited since they are locked.

F12.02 chooses 1 or 2, that parameter cannot be changes will happen. Please F12.02 is set to 0. If the user password is enabled that parameter cannot be changes will happen again.

9.3.2 Abnormal Motor Operation

- After pressing , motor does not run.
 - Start/Stop is in the terminal control mode: Check the setting of F00.02.
 - Coast-to-stop terminals FRS is connected to COM: Disconnect FRS from COM.
 - When the terminal (Run Command Switched to Terminal) is on and run command is only in terminal control mode: Switch the terminal off.
 - Status combination of run command input is in terminal control mode: Change it to keypad control mode.
 - Setting reference input frequency= 0: Increase reference input frequency.
 - Power supply is abnormal or control circuit fails.
- When control terminals RUN and F/R are ON, motor does not run.
 - External terminal start/stop setting is disabled: Check the setting of F00.02.

- Coast-to-stop terminal FRS=ON: Switch FRS=OFF.
- Control switch is disabled: Check control switch.
- Setting reference input frequency= 0: Increase reference input frequency.
- Motor can only run in one direction.
Reverse prohibited: When F00.21=1, inverter reverse is prohibited.
- Motor reverses

The output phase sequence of inverter is not identical to that of motor input: When power is off, the running direction of motor can be changed by switching any of the two connection wires on the output side of inverter.

9.3.3 Excessively Long Acceleration Time

- Excessively low setting of current limit

When current limit is enabled, if output current of inverter reaches its set current limit, then output frequency will remain unchanged in acceleration, and it will rise continuously only until output current is lower than the setting current limit. In this case, the acceleration time of motor is longer than the set time. Check if the set current limit of inverter is excessively low.

- If the set acceleration time is too long, confirm its parameters.

9.3.4 Excessively Long Deceleration Time

- When energy consumption brake is enabled,
 - The brake resistance is too big. The energy consumption brake power is too small, so the deceleration time is prolonged.
 - The set value of brake duty ratio (F15.32) is too small, and the deceleration time is prolonged. Please increase the set value of brake duty ratio.
 - If the set acceleration time is too long, confirm its parameters.
- When overvoltage stall protection is enabled,
 - Overvoltage stall protection is enabled, when DC bus voltage exceeds the overvoltage stall voltage (F07.07); output frequency remains unchanged. When DC bus voltage is lower than the set value of F07.07, output frequency drops continuously and therefore the deceleration time is prolonged.

- If the set acceleration time is too long, confirm its parameters.

9.3.5 Electromagnetic Interference (EMI) and Radio Frequency Interference (RFI)

● When inverter runs in high frequency switch status, it will generate EMI and RFI on the control devices. Take following countermeasures:

- Lower carrier frequency of inverter (F00.23).
- Install a noise filter on the input side of inverter.
- Install a noise filter on the output side of inverter.
- Shield cable with a metal tube, and place inverter in a metal case.
- Inverter and motor must be grounded reliably.
- Main circuit and control circuit should be wired separately. Control circuit should adopt shielded wire, and see Chapter 3 for wiring.

9.3.6 Leakage Current Circuit Breaker for Leakage Protection

● When inverter runs, leakage current circuit breaker is triggered for leakage protection.

Inverter outputs high-frequency PWM signal, which generate high-frequency leakage current. Please select a leakage circuit breaker with trigger current $\geq 30\text{mA}$. For a regular circuit breaker, trigger current $\geq 200\text{mA}$ and active time at 0.1S or above.

9.3.7 Mechanical Vibration

- Fixed frequency of mechanical system resonates with carrier frequency of inverter.
Motor has no problem, but sharp noises generated by the mechanical system resonate between fixed frequency of mechanical system and carrier frequency of inverter. Please adjust carrier frequency F0-14 to avoid resonant frequency.
- Fixed frequency of mechanical system resonates with output frequency of inverter.
Fixed frequency of mechanical system resonates with output frequency of inverter. Please use the oscillation suppression function (F05.13) or install a vibration-proof rubber at motor bottom plate and take any other vibration-proof measures.
- PID Control Oscillation

P, Ti and Td of PID controller do not match in setting properly. Reset PID parameters.

9.3.8 Inverter Stops Output While Motor Still Rotates

- Insufficient DC Brake at Stop
 - DC brake torque at stop is too small. Please increase the set value of DC brake current at stop (F04.21).
 - DC Brake Time at Stop is too short. Please increase DC brake time at stop (F04.22). Generally speaking, increase DC brake current at stop first.

9.3.9 Output Frequency Not As Per the Set Frequency

- The set frequency exceeds the upper limit frequency.

If the set frequency exceeds the set value of the upper limit frequency, then output frequency should be the upper limit frequency. Reset the set frequency within the upper limit frequency; or check whether F00.16, F00.17 and F00.18 are appropriate.

10. Maintenance and Inspection

10.1 Routine Maintenance and Inspection of inverter

Changes of working environment of inverter, such as temperature, humidity, smog, dust and so on, as well as aging of the inner parts of inverter inner, may cause various faults of inverter. Therefore, routine inspection and regular maintenance should be performed during the process of storage and use.

- Before using inverter, user shall check if the components are broken or the screws are loose during transportation.
- While using inverter, user shall regularly clean the dust and check whether the screws are loosened.
- If inverter is left unused for a long term, user is recommended to power on inverter every half year during the storage. Every time, inverter shall be powered on for half an hour. This will prevent the electronic device from invalidation.
- Keep inverter away from heavy humidity and metal particles. If necessary, put it in an electric cabinet or a small room with protective measures.

When inverter is in normal running, please check the items below:

- Whether motor has abnormal sound and vibration.
- Whether inverter and motor are overheated abnormally.
- Whether the ambient temperature is too high.
- Whether output current value is normal.
- Whether the cooling fan of inverter runs normally.

According to service conditions, clients shall regularly inspect inverter for clearing faults and potential safety hazards. Cut off the power supply before checking, and start checking after the keypad LED goes out. The items to be checked are shown in Table 10-1.

Table 10-1 Items for Routine Check

Items	Inspection content	Countermeasures
Screws of main circuit terminal and control circuit terminal.	Whether the screws are loosened.	Tighten the screws with a screwdriver.
Cooling fin PCB	Whether there is dust or foreign object.	Clean up dust and foreign objects with dry-compressed air of 4-6kg/cm ² pressure.
Cooling fan	Whether there is abnormal sound or vibration. Whether the accumulated running time has reached to 20,000 hours.	Replace the cooling fan.
Power module	Whether there is dust.	Clean up dust and foreign objects with dry-compressed air of 4-6 kg/cm ² pressure.
Electrolytic Capacitor	If there are phenomena of changing color, foreign odor and blister.	Replace the electrolytic capacitor.

In order to make inverter operate normally, regular maintenance and change must be performed for purpose of the service life of the inner components of inverter. The service lives of inverter components vary with the service environment and conditions. In Table 10-2, the replacement terms of the components of the inverter are for user reference.

Table 10-2 Replacement Terms of the Components of inverter

Component	Standard replacement years
Cooling fan	2 – 3 years
Electrolytic capacitor	4 – 5 years
PCB (Printed circuit board)	5 – 8 years

In the table above, the replacement terms are based upon service conditions for the components of inverter below:

Ambient temperature: annual average 30 °C.

Load factor: below 80%.

Running time: Below 12 hours per day.

10.2 Warranty Instruction for Inverter

SINEE will offer the warranty service if inverter has the following conditions:

Warranty is only for inverter; the warranty service will be provided to inverter that has a fault or is damaged within 12 months during normal use; if inverter has a fault or is damaged outside the 12-month period during normal use, reasonable maintenance charge is required.

There is maintenance charge for any following damage occurred in 12 months:

- Due to improper operation.
- Due to floods, fires, or abnormal voltage fluctuations.
- Due to the incorrect wiring.
- Due to unauthorized modifying or altering.
- The service fees are subject to the actual fees.
- If there is another protocol, the protocol shall apply.

11. Options

11.1 Braking Resistor

If motor speed falls too fast or motor load shakes too frequently during inverter running, then its electric potential energy will charge inner capacitor through inverter in a reverse way, leading to the voltage pump up at both ends of power module, which easily causes inverter to be damaged. Internal control of inverter can suppress this situation based on load condition and when braking feature cannot meet the user demands, external braking resistor is required to release energy timely. External braking resistor functions for energy consumption brake, which will dissipate all the energy to power braking resistor. So, select reasonable and effective power and resistance for the braking resistor.

The power of braking resistor is according to the following formula.

P_b (The power of braking resistor) = P (the power of inverter) * D (braking frequency)

D - Braking frequency (estimated value)

Normally braking $D = 10\%$

Occasionally braking $D = 5\%$

Elevator braking $D=10\% \sim 15\%$

Lifting braking for height more than 100m $D= 50\% \sim 60$

The table below for the EM500 series inverter is recommended rated power of braking resistor which is for reference only ($D=10\% \sim 20\%$). If braking frequency is larger the power of braking resistance should be larger.

Inverter model	Motor (kW)	Resistance (Ω)	Resistor power (W)	Cable connected to the resistor (mm^2)
EM500-0R7G/1R5P-1B/2B/3B	0.75	≥ 360	≥ 200	1
EM500-1R5G/2R2P-1B/2B/3B	1.5	≥ 180	≥ 400	1.5

EM500-2R2G/3R0P-1B/2B/3B	2.2	≧ 180	≧ 400	1.5
EM500-4R0G/5R5P-3B	4	≧ 90	≧ 800	2.5
EM500-5R5G/7R5P-3B	5.5	≧ 60	≧ 1000	4
EM500-7R5G/9R0P-3B	7.5	≧ 60	≧ 1000	4
EM500-011G/015P-3B	11	≧ 30	≧ 2000	6
EM500-015G/018P-3B	15	≧ 30	≧ 2000	6
EM500-018G/022P-3B	18.5	≧ 30	≧ 2000	6
EM500-022G/030P-3/3B	22	≧ 15	≧ 4000	6
EM500-030G/037P-3/3B	30	≧ 15	≧ 4000	6
EM500-037G/045P-3/3B	37	≧ 10	≧ 6000	6
EM500-045G/055P-3/3B	45	≧ 10	≧ 6000	6
EM500-055G/075P-3/3B	55	≧ 7.5	≧ 8000	6
EM500-075G/090P-3/3B	75	≧ 6	≧ 8000	6

★ The cable listed above refers to outgoing line of individual resistor. When resistor is connected in parallel, the bus in connection should be amplified accordingly.

Single-phase inverter selects voltage withstanding type cable of AC300 V, 3-phase inverter uses cable of over AC450V and temperature resistance 105 °C.

11.2 Braking Unit

If EM500 inverter (over 18.5 kW) has no built-in braking unit, then user shall select our BR100 braking units (power range: 18.5 – 315 kW). Models of braking units are listed below:

Model No.	Minimum resistance (Ω)	Average braking current I_{av} (A)	Peak current I_{max} (A)	Inverter power (kW)
BR100-045	10	45	75	18.5 - 45
BR100-160	6	75	150	55 - 160
BR100-315	3	120	300	185 - 315

★ When BR100-106 adopts minimum resistance, if braking frequency of braking unit $D=33\%$, it can continue to work. If $D>33\%$, it needs to work intermittently, otherwise an overheat protection fault will occur.

11.3 Options of Cable

Because all the braking units and braking resistors work at high voltage (>400VDC) discontinuously, please select the appropriate cable. See Table 11-1 for specification of the cable of the main circuit. During wiring, only those cable with the insulation grade and the section meeting standards should be used.

Table 11-1 Cable for Braking Unit and Braking Resistor

Model No.	Average braking current I_{av} (A)	Peak current I_{max} (A)	Section of copper core cable (mm ²)
BR100-045	45	75	10
BR100-160	75	150	16
BR100-315	120	300	25

Flexible cable has better flexibility. Since cable may contact high-temperature device during use, it's better to use copper core or heat-proof flexible cable or fire-retardant cable. Braking unit and inverter should be as close as possible to each other, and it's better to keep their distance no more than 2 m, otherwise DC side cable should be twisted and sheathed with magnetic ring to reduce radiation and inductance.

The length of the cable between inverter and braking unit should be less than 2m. The length of the cable between braking unit and braking resistor can be more than 2m.

11.4 Option Card

11.4.1 I/O Expansion Card Configuration

I/O expansion card is used for the expansion of inverter control terminal. Specific model of I/O card is listed in Table 11-2.

Table 11-2 Model List of I/O Card

Model No.	Description	Terminal Function
EC-IO-A1	I/O Expansion Card	4 numeric multi-function digital signal inputs: X8 - X11 1 numeric signal output: Y3 1 analog signal input: AI4
EC-IO-A3	I/O Expansion Card 3	1 relay output (NO): Y3 1 temperature input: T1/T2 1 power supply: +15Vdc

11.4.2 Communication Card Configuration

EM500 inverter is equipped with multiple communication expansion cards. Models of expansion cards are listed in Table 11-3.

Table 11-3 Models of Communication Expansion Cards

Model No.	Description	Communication Rate
EC-CM-C1	CANopen Communication Card	125 kbps, 250 kbps, 500 kbps and 1 Mbps
EC-CM-D1	DeviceNet Communication Card	125 kbps, 250 kbps and 500 kbps
EC-CM-P1	Profibus-DP Communication Card	Bit rate self-adaptation

11.4.3 Dedicated Functions Interface card configuration scheme description

EM500 inverter is equipped with a variety of special function expansion card, expansion card specific models are shown in Table 11 3.

Table 11-3 Models of Communication Expansion Cards

Model No.	Description	Application field
EC-IO-K2	Air compressor interface card	Air compressor Application
EC-TM-A1	Clock cards	Water supply Application
EC-PSPP-A1	Phase sequence phase detection card	Synchronous machine frequency conversion

11.5 Base

The five specifications of EM500 inverters may have an installation base that has the same width as that of corresponding inverter, as shown in Figure 11-2. The installation method for EM500 is changed to the cabinet mounting. If required, please indicate it while ordering and install it by yourself. Refer to Figure 11-3 for details. The installation dimensions for the anchor bolt of the base are shown in Figure 11-4

Table 11-4 Base Installation Dimensions

Model No.	Base Height(mm)	W(mm)	H(mm)	d(mm)
EM500-055G - 075G	165	300	243	13
EM500-090G - 132G	253	300	243	13
EM500-160G - 200G	253	300	258	13
EM500-220G - 280G	308	416	293	13
EM500-315G - 400G	300	500	340	13

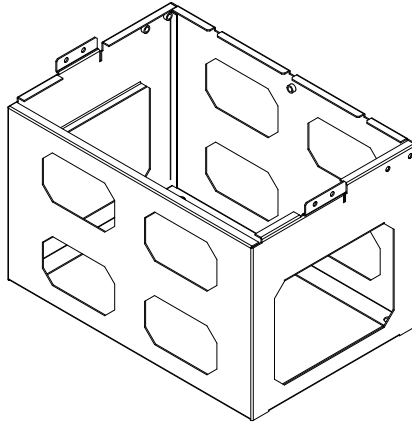

Figure 11-2 Base

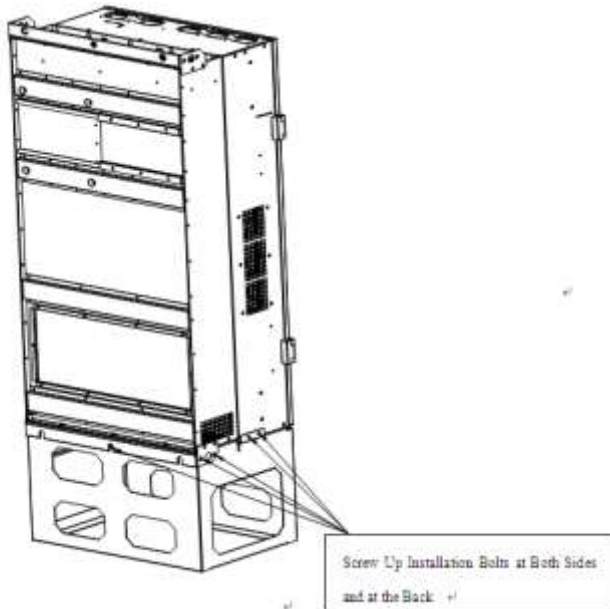

Figure 11-3 Base Installation

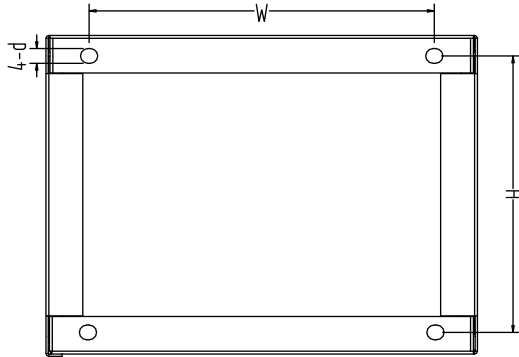

Figure 11-4 Installation Dimensions of Anchor Bolt of Base

EM500 large-power inverter (450 - 560kW) can be accompanied with an installation base and top cover with the same width as inverter (refer to Figure 11-6). The overall inverter height can be changed to 2000mm, if base or top cover will be replaced; the overall inverter can be changed to 2200mm, if both base and top cover will be replaced. If required, please inform while ordering and complete installation by yourself. See Figure 11-6 for details.

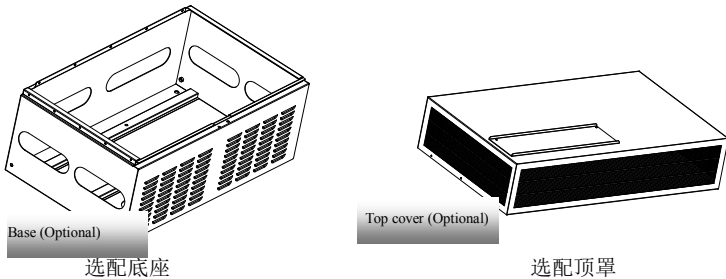

Figure 11-5 Base and Top Cover of Inverter (450 - 560kW)

To install top cover, only need to tighten up 9 M5*12 screws on both sides and on the back.

To replace base, you only need to remove 15 M6*14 bolts on both sides and on the back.

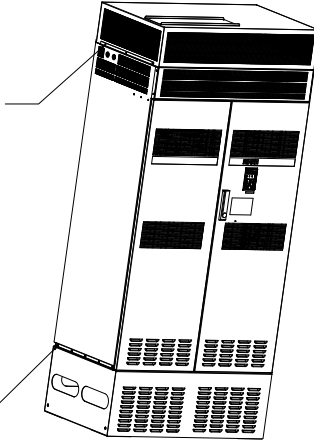

Figure 11-6 Installation of Base and Top Cover of Inverter (450 - 560kW)

11.6 Upper Mounting Hole

EM500 large-power inverter (450 - 560kW) can be accompanied with upper mounting hole to make the machine stand against wall with machine back. If required, please inform while ordering and complete installation by yourself. See Figure 11-7 for details.

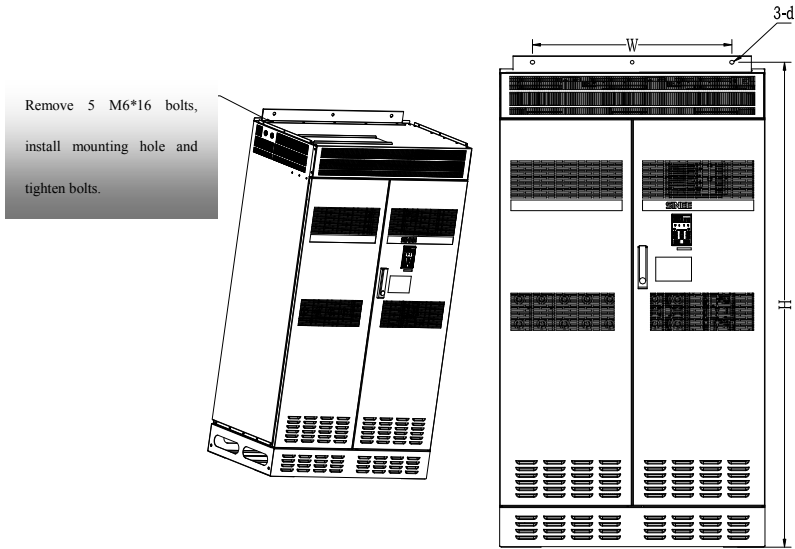

Figure 11-7 Installation of Upper Mounting Hole

Table 0-1 Installation Dimension of Upper Mounting Hole

Model No.	W(mm)	H(mm)	d(mm)
EM500-450G/500P-3	753	1825	14
EM500-500G/560P-3			
EM500-560G/630P-3			

11.7 Copper Row for Incoming and Outgoing Cable Switchover

Two specifications of EM500 may have a copper row for incoming and outgoing cable switchover. They can be wired outside the case (see Figure 11-8). If required, please indicate it while ordering and install it by yourself.

Model No.	List of options
EM500-220G - 280G	Copper row for incoming and outgoing cable switchover, installation bolt and insulator
EM500-315G - 400G	Copper row for incoming and outgoing cable switchover, installation bolt and insulator

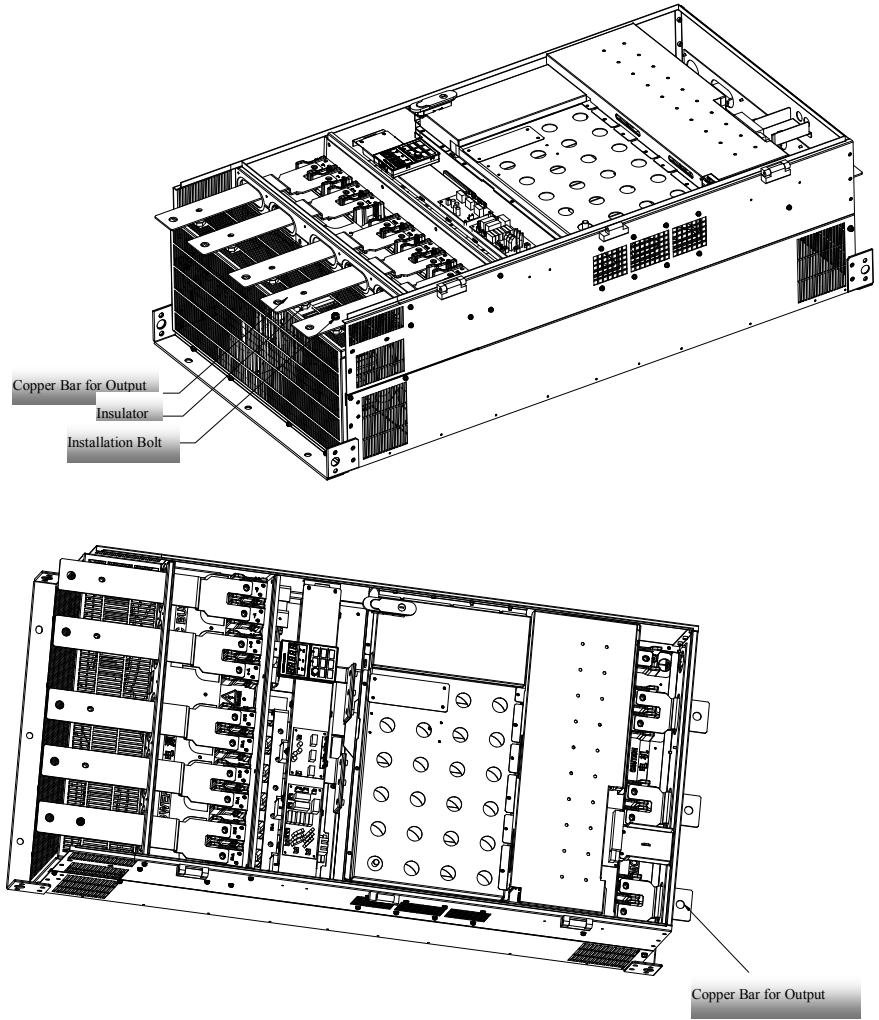
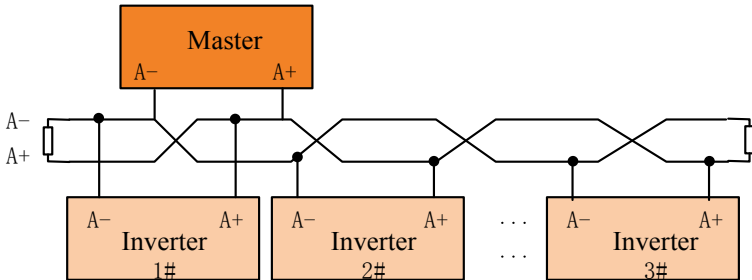

Figure 11-8 Installation of Copper Row for Incoming and Outgoing Cable Switchover

12. MODBUS Communication Protocol

12.1 Application Scope

1. Applicable series: EM500
2. Applicable network: Support MODBUS-RTU protocol, with the single-master/multi-slave communication network of RS-485 bus.



12.2 Physical Interface

RS-485 asynchronous half-duplex communication mode is with the least significant bit given the priority for transmittance.

RS-485 network address: 1 – 247 available for setting, 0 is the broadcast address.

RS-485 terminal default data format: 1-8-N-1^[2] (1-8-E-1, 1-8-O-1, 1-8-N-2, 1-8-E-2 and 1-8-O-2, optional).

Default bit rate of RS-485 terminal: 9600 bps (4800 bps, 19200 bps, 38400 bps, 57600 bps and 115200 bps, optional);

It's recommended to use shielded twisted cable as communication cable so as to reduce impacts of external disturbance upon communication.

[2] 1-8-N-1, 1 start bit – 8 characters per byte data – nonparity 1 – 1 stop bit. E, even parity; o, odd parity.

12.3 Protocol Format

12.3.1 Message Format

As shown in Figure 12-1, one standard MODBUS message includes start mark, RTU message (Remote Terminal Unit) and end mark.

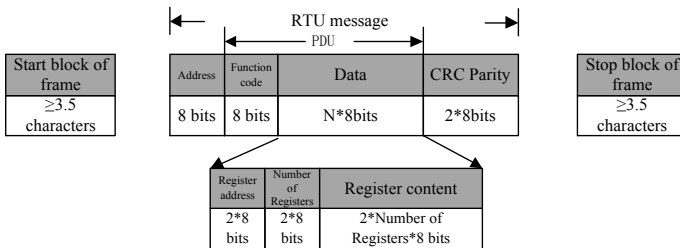

Figure 12-1 RTU Message Frame

RTU message includes address code, PDU (Protocol Data Unit) and CRC[3] Parity. PDU includes the function code and data (mainly including register address, register number and register content; all function codes have different definitions, see the function code 12.3.3).

[3]: CRC parity, with the low byte in the front and the high byte in the back.

12.3.2 Address Code

Address Scope	Purpose
1 - 247	Slave
0	Broadcast

12.3.3 Function Code

MODBUS function code classification is shown in Figure 12-2.

127 (0x7F)	Common Function Code
110 (0x6E)	User-Defined Function Code
100 (0x64)	
	Common Function Code
72 (0x48)	User-Defined Function Code
65 (0x41)	
	Common Function Code
1 (0x1)	Common Function Code

Figure 12-2 MODBUS Function Code Classification

As shown in Table 12-1, EM500 inverters mainly involve common function codes, for example 0x03 read multiple registers or status words, 0x06 write single register or command, 0x10 write multiple registers or commands, and 0x08 diagnosis function code.

Besides, to perform some special functions, for example write register RAM and not to save in EEPROM, user should define 0x41 as write single register or command (no to save) and 0x42 as write multiple registers or commands in the user-defined function code area (no to save).

After receiving abnormal valid data from device, relevant abnormal information (see 12.3.7 Abnormal Information Response) will be returned. For distinguishing it from the normal communication data, abnormal function codes are defined. Similar to normal request function code, **abnormal function code = request function code + 0x80**.

Table 12-1 EM500 Defined Function Code

Function Code	Abnormal Function Code	Function
03	83	Read multiple registers or status bytes
41	C1	Write single register or command (not to save)
42	C2	Write multiple registers or commands (not to save)
08	88	Diagnosis function code
06	86	Write single register or command
10	90	Write multiple registers or commands

In the following sections, those PDU parts that are different due to functions shall be explained in detail.

12.3.3.1 Function Code 0x03 Read Multiple Registers or Status Bytes

In a remote device, inverter uses this function code to read the content of the continuous blocks of the holding register. The request PDU indicates the start register address and the Number of Registers.

Divide register data of the response message into two bytes for each register. For each register, the first byte includes high bit, the second byte includes low bit.

- Request PDU

Function Code	1 byte	0x03
Initial Address	2 bytes	0x0000 - 0xFFFF
Number of Registers	2 bytes	1 - 16

- Response PDU

Function Code	1 byte	0x03
Number of Bytes	1 byte	2×N*
Register Value	N*×2 bytes	

N*=Number of Registers

- Incorrect PDU

Error Code	1 byte	0x83
Exceptional Code	1 byte	01, 02, 03 or 04

The following is an example of requesting to read registers F19.00 - F19.05 (relevant information about the last fault)

Request		Response			
Field Name	(0x)	Field Name (normal)	(0x)	Field Name (abnormal)	(0x)
Function Code	03	Function Code	03	Function	83
Initial Address Hi	13	Number of Bytes	0C	Exceptional Code	03 (Example, the same below)
Initial Address Lo	00	Register Value Hi (F19.00)	00		
Number of Registers Hi	00	Register Value Lo (F19.00)	11		
Number of Registers Lo	06	Register Value Hi (F19.01)	00		
		Register Value Lo (F19.01)	00		
		Register Value Hi (F19.02)	00		
		Register Value Lo (F19.02)	00		
		Register Value Hi	01		

	(F19.03)		
	Register Value Lo (F19.03)	2C	
	Register Value Hi (F19.04)	00	
	Register Value Lo (F19.04)	00	
	Register Value Hi (F19.05)	00	
	Register Value Lo (F19.05)	00	

Telling from the returned data, inverter has suffered 17 (0011H): abnormal failure of the temperature sensor. At the time, there are output frequency 0.00 Hz, output current 0.00 A, bus voltage 300 V (012CH), acceleration/deceleration status (standby) and working hours 0 hour.

★ The present function code 0x03 of MODBUS protocol supports “cross-group read of multiple function codes”; but user is not recommended to do cross-group read, so that user’s application does not need to upgrade after we upgrade our products.

12.3.3.20x41 Write single register or command (not to save)

This function code can be used to write single non-holding register in a remote device.

Request PDU describes the address of the written register.

Normal response is a response to the request and returned after writing the register

- Request PDU

Function Code	1 byte	0x41
Register Address	2 bytes	0x0000 - 0xFFFF
Register Address	2 bytes	0x0000 - 0xFFFF

- Response PDU

Function Code	1 byte	0x41
Register Address	2 bytes	0x0000 - 0xFFFF
Register Value	2 bytes	0x0000 - 0xFFFF

- Incorrect PDU

Error Code	1 byte	0xC1
Exceptional Code	1 byte	See Table 12–4

The following is an example of a request for changing the main frequency source A (7001H) to “-50.00%”:

Request		Response			
Field Name	(0x)	Field Name (normal)	(0x)	Field Name (abnormal)	(0x)
Function	41	Function	41	Function	C1
Register Address Hi	70	Register Address Hi	70	Exceptional Code	03
Register Address Lo	01	Register Address Lo	01		
Register Value Hi	EC	Register Value Hi	EC		
Register Value Lo	78	Register Value Lo	78		

★ The function code cannot be used to change the parameters of “○” property (unavailable to be modified during inverter running), i.e., user may only operate the parameters of “●” properly (available to be modified during inverter running). If user tries to modify the “○” property, an error code 1 will be returned.

12.3.3.30x42 Write multiple registers or commands (not to save)

This function code is used to write continuous non-holding save register blocks (1 to 16 registers) in a remote device.

The value requested for writing is described in the request data field. Each register divides the data into two bytes.

Normal response shall return function, initial address and number of registers written.

- Request PDU

Function Code	1 byte	0x42
Initial Address	2 bytes	0x0000 - 0xFFFF

Number of Registers	2 bytes	1 - 16
Number of Bytes	1 byte	2×N*
Register Value	N*×2 bytes	

N*=Number of Registers

- Response PDU

Function Code	1 byte	0x42
Initial Address	2 bytes	0x0000 - 0xFFFF
Number of Registers	2 bytes	1 - 16

- Incorrect PDU

Error Code	1 byte	0xC2
Exceptional Code	1 byte	See Table12-4

The following is an example of a request for setting acceleration time 1 (F00.14) as 5.00 and deceleration time 1 (F00.15) as 6.00:

Request		Response			
Field Name	(0x)	Field Name (Normal)	(0x)	Field Name (abnormal)	(0x)
Function	42	Function	42	Function	C2
Initial Address Hi	00	Initial Address Hi	00	Exceptional Code	03
Initial Address Lo	0E	Initial Address Lo	0E		
Number of Registers Hi	00	Number of Registers Hi	00		
Number of Registers Lo	02	Number of Registers Lo	02		
Number of Bytes	04				
Register Value Hi (F00.14)	01				
Register Value Lo (F00.14)	F4				
Register Value Hi (F00.15)	02				
Register Value Lo (F00.15)	58				

★ The function code cannot be used to change the parameters of “○” property (unavailable to be modified during inverter running), i.e., user may only operate the parameters of “●” property (available to be modified during inverter running). If user tries to modify the “○” property, an error code 1 will be returned.

12.3.3.4 0x08 Diagnosis function code

Function code 08 of Modbus offers a series of tests for checking the communication system between client end (master) and server (slave) or checking various internal error statuses in the server.

This function uses 2-byte sub-function code field in the inquiry to define the executed test type. The servo will copy function code and sub-function code in normal response. Some diagnoses can cause a remote device to return corresponding data through the normal response data field.

Generally, sending diagnosis function command to a remote device will not affect the user program in remote device. The diagnosis function can not have access to user logic, for example discrete magnitude and register. Some functions can be used to reset the error counter in the resent device.

The diagnosis function of our products is mainly line diagnosis (0000) and used for testing normal communication of master and slaves. The normal response to the inquiry data request should be returning the same data and copying the function code and the sub-function code.

- Request PDU

Function Code	1 byte	0x08
Sub-Function Code	2 bytes	0x0000 - 0xFFFF
Data	2 bytes	0x0000 - 0xFFFF

- Response PDU

Function Code	1 byte	0x08
Sub-Function Code	2 bytes	0x0000 - 0xFFFF
Data	2 bytes	0x0000 - 0xFFFF

- Incorrect PDU

Error Code	1 byte	0x88
Exceptional Code	1 byte	See Table 12-4

- Sub-Function Code

Sub-Function	Indication	Data Field (Request)	Data Field (Request)
0000	Return Inquiry Data	Any	Copy the request data
...			

0000: return the data transmitted in the request field in response. All messages should be request messages.

The following is an example of requesting the remote device to return inquiry data. It uses sub-function code 0000. Using 2-byte data field (0xA537) to return data.

Request		Response			
Field Name	(0x)	Field Name (normal)	(0x)	Field Name (abnormal)	(0x)
Function	08	Function	08	Function	88
Sub-Function Code Hi	00	Sub-Function Code Hi	00	Exceptional Code	03
Sub-Function Code Lo	00	Sub-Function Code Lo	00		
Data Hi	A5	Data Hi	A5		
Data Lo	37	Data Lo	37		

23.3.3.50x06 Write single register or command

This function code is used to write single holding register in a remote device.

Request PDU describes the address of the written register

Normal response is a response to the request and returned after writing the register.

- Request PDU

Function Code	1 byte	0x06
Register Address	2 bytes	0x0000 - 0xFFFF
Register Value	2 bytes	0x0000 - 0xFFFF

- Response PDU

Function Code	1 byte	0x06
Register Address	2 bytes	0x0000 - 0xFFFF
Register Value	2 bytes	0x0000 - 0xFFFF

- Incorrect PDU

Error Code	1 byte	0x86
Exceptional Code	1 byte	See Table 12-4

The following is an example of requesting to change motor 1 drive control mode (F0 0.01) to 1: FVC:

Request		Response			
Field Name	(0x)	Field Name (normal)	(0x)	Field Name (abnormal)	(0x)
Function	06	Function	06	Function	86
Register Address Hi	00	Register Address Hi	00	Exceptional Code	03
Register Address Lo	01	Register Address Lo	01		
Register Value Hi	00	Register Value Hi	00		
Register Value Lo	01	Register Value Lo	01		

★ Those function codes of inverter that are frequently changed can not complete this function with the function code 0x06 to avoid damaging inverter.

0x41 RAM & EEPROM, a user-defined function code, corresponds to the standard common function code 0x06; the definition of this function code is the same as corresponding standard function codes (in request, response and error PDU). The only difference is that when this function code is enabled, only corresponding value of RAM is modified, without being saved to EEPROM (holding register).

For those function codes that are often changed, like F00.07, it's recommended to use the function code 0x41 (user may also operate 7001H directly by modifying main frequency source A, refer to 12.3.3.2 and 12.3.4 for details) to avoid damaging inverter. See the following descriptions for details.

Request		Response	
Field Name	(0x)	Field Name (normal)	(0x)
Function	41	Function	41
Register Address Hi	00	Register Address Hi	00
Register Address Lo	07	Register Address Lo	07
Register Value Hi	13	Register Value Hi	13
Register Value Lo	88	Register Value Lo	88

The data above means to change the set frequency (F00.07) to 50.00Hz, which will take effect immediately, but will not be saved in EEPROM. After rewriting, inverter runs at the frequency 50.00 Hz, but runs at the frequency set prior to change after inverter is power on

12.3.3.60x10 Write multiple registers or commands

This function code is used to write continuous register blocks (1 to 16 registers) in a remote device.

The value requested for writing is described in the request data field. Each register divides the data into two bytes

The normal response is to return the function code, the initial address and the number of registers written.

- Request PDU

Function Code	1 byte	0x10
Initial Address	2 bytes	0x0000 - 0xFFFF
Number of Registers	2 bytes	1 - 16
Number of Bytes	1 byte	2×N*
Register Value	N*×2 bytes	

N*=Number of Registers

- Response PDU

Function Code	1 byte	0x10
Initial Address	2 bytes	0x0000 - 0xFFFF
Number of Registers	2 bytes	1 - 16

- Incorrect PDU

Error Code	1 byte	0x90
Exceptional Code	1 byte	See Table12-4

The following is an example of requesting to write 00 01 and 00 03 in the two registers starting from F03.00, i.e., setting the functions of output terminals Y1 and Y2

Request		Response			
Field Name	(0x)	Field Name (normal)	(0x)	Field Name (abnormal)	(0x)
Function	10	Function	10	Function	90
Initial Address Hi	03	Initial Address Hi	03	Exceptional Code	03
Initial Address Lo	00	Initial Address Lo	00		
Number of Registers Hi	00	Number of Registers Hi	00		
Number of Registers Lo	02	Number of Registers Lo	02		
Number of Bytes	04				
Register Value Hi (F03.00)	00				
Register Value Lo (F03.00)	01				
Register Value Hi (F03.01)	00				
Register Value Lo (F03.01)	03				

★ Those function codes of inverter that are frequently changed can not complete this function with the function code 0x10 to avoid damaging inverter. Refer to 12.3.3.5 for details.

12.3.4 Allocation of Register Address

Table 12-2 MODBUS Protocol Register Address Definitions

Address Space	Description
Function Code 0000H - 6F63H	For function codes FXX.YY, their high addresses are in hexadecimal format of XX and their low addresses are in hexadecimal format of YY. For example F00.14, its address is 000EH (00D=00H, 14D=0EH).

Function Code (not to save after power off) 8000H~EF63H		By function code of 0x06 or 0x10 to set parameter “original address + 8000H” will be “effect immediately and not to save after power off”. For example F00.14, its address is 800EH (000EH + 8000H)	
Control Command (Write Only) 7000H - 71FFH	7000H Control Word	0000H	Disabled Command
		0001H	Forward Running
		0002H	Reverse Running
		0003H	Forward JOG
		0004H	Reverse JOG
		0005H	Ramp-To-Stop
		0006H	Rapid Stop
		0007H	Coast-to-Stop
		0008H	Fault Reset
		0009H	+/-Input Switch
		000BH	JOG Stop
	Other - 00FFH	Not Used	
	7001H	Main Channel Frequency A Communication Setting	-100.00% - 100.00% (100%=maximum frequency)
	7002H	Auxiliary Channel Frequency B Communication Setting	-100.00% - 100.00% (100%=maximum frequency)
	7003H	Torque Communication Setting	-200.00% - 200.00% (100%=Numeric Setting)
	7004H	Process PID Communication Setting	-100.00% - 100.00%
	7005H	Process PID Feedback Communication Setting	-100.00% - 100.00%
	7006H	VF separation mode voltage setting	0.00% - 100.00%(Numeric Setting Reference)
	7007H - 7009H	Not Used	
700AH	Upper Limit	0.00% - 200.00%(Numeric Setting)	

		Frequency Communication Setting	Reference)	
	700BH	Upper Limit Frequency Setting of Torque Control	0.00% - 200.00%(Numeric Setting Reference)	
	700CH	Linear Speed Input of Inertia Compensation	0.00% - 100.00%(Numeric Setting Reference)	
	700DH - 700EH	Not Used		
	700FH	Master-Slave Communication Setting	-100.00% - 100.00%(Maximum Reference Value)	
	7010H - 7013H	Not Used		
	7014H	External Fault	External device (option card) fault input	
	7015H	Communication Setting of Main Channel Frequency A	0.00Hz - maximum frequency	
	7016H	Communication Setting of Auxiliary Channel Frequency B	0.00Hz - maximum frequency	
	7017H	Communication Setting of Upper Limit Frequency	0.00Hz - maximum frequency	
	7018H	Communication Setting of Upper Limit Frequency at Torque Control	0.00Hz - maximum frequency	
	7019H	Communication Setting of Upper Limit Torque at Speed Control	0.0~250.0%	
	7020H - 71FFH	Not Used		
Working	Status word 1	Bit7 - 0	00H	Parameter Setting
		Running Status	01H	Slave Running

Condition 7200H - 73FFH			02H	JOG Running	
			03H	Autotuning Status	
			04H	Slave Stop	
			05H	JJOG Stop	
			06H	Fault Status	
			07H	Factory Inspection	
			08H - 0FFH	Not Used	
		Bit15 - 8 Fault Information		00H	Inverter runs normally
				xxH	Fault status of inverter, “xx” is the fault code
		7201H Status word 2	Bit0 Set Direction	1	- Valid Setting
				0	+Valid Setting
			Bit1 Running Direction	1	Frequency Output, Reverse
				0	Frequency Output, Forward
			Bit3 - 2 Control Mode	00	Speed Control Mode
				01	Torque Control Mode
				10	Not used
				11	Not used
			Bit4 Parameter Protection	1	Enabled
				0	Disabled
			Bit6 - 5	Not Used	
			Bit8 - 7 Set Mode	00	Keypad Control
				01	Terminal Control
				10	Communication Control
		11		Not used	
		Bit9	Not used		
		Bit10 warning	0	No Warning	
			1	Warning Status (See 7230H)	
		Bit15 - 11	Not used		
		7202H Monitoring frequency +/- status word 1 (1: -; 0: +)	Bit0	Output Frequency	
			Bit1	Input Frequency	
			Bit2	Synchronous frequency	
			Bit3	Not Used	
	Bit4		Estimated Feedback Frequency		
	Bit5		Estimated Slip Frequency		

	Bit6	Load Speed							
	Bit15 - 7	Not Used							
7203H	Output Frequency								
7204H	Output Voltage								
7205H	Output Power								
7206H	Running Speed								
7207H	Bus Voltage								
7208H	Output Torque								
7209H	Switch Input 1	15	14	13	12	11	10	9	8
		*	*	*	*	*	X11	X10	X9
		7	6	5	4	3	2	1	0
		X8	X7	X6	X5	X4	X3	X2	X1
720AH	Switch Output 2	15	14	13	12	11	10	9	8
		VX8	VX7	VX6	VX5	VX4	VX3	VX2	VX1
		7	6	5	4	3	2	1	0
		*	*	*	*	AI4	AI3	AI2	AI1
720BH	Switch Output 1	15	14	13	12	11	10	9	8
		*	*	*	*	*	*	*	*
		7	6	5	4	3	2	1	0
		*	*	*	Y3	Y2	Y1	R2	R1
720CH	Switch Output 2	15	14	13	12	11	10	9	8
		VY8	VY7	VY6	VY5	VY4	VY3	VY2	VY1
		7	6	5	4	3	2	1	0
		*	*	*	*	*	*	*	*
Last Two Faults	Last Two Faults								
720EH	Last Three Faults								
720FH	Last Fault								
7210H	Last Fault Output Frequency								
7211H	Last Fault Output Current								
7212H	Last Fault Bus Voltage								
7213H	Last Fault Running Status								
7214H	Last Fault Working Time								
7215H	Set Acceleration Time								
7216H	Set Deceleration Time								
7217H	Cumulative length								
7218H	Not Used								
7219H	UP/DOWN Offset Frequency Symbol (0/1: +/-)								
7224H	Output Current								

	7225H	Reference Frequency	
	7228H	Total Time of power on	
	7230H	Warning Number	
	others - 73FFH	Not Used	
Product Information 7500H - 75FFH	7500H	Performance Software Serial Number 1	Correspond to F12.22
	7501H	Performance Software Serial Number 2	Correspond to F12.23
	7502H	Function Software Serial Number 1	Correspond to F12.24
	7503H	Function Software Serial Number 2	Correspond to F12.25
	7504H	Keypad Software Serial Number 1	Correspond to F12.26
	7505H	Keypad Software Serial Number 2	Correspond to F12.27
	7506H	Product Serial Number 1	Correspond to F12.28
	7507H	Product Serial Number 2	Correspond to F12.29
	7508H	Product Serial Number 3	Correspond to F12.30
	7509H - 75FFH	Not Used	
Other	Not Used		

12.3.5 Data Frame Length

The number of read/write registers for PDU of RTU frame of MODBUS message falls into the scope between 1 and 16. As for different function codes, the actual lengths of RTU frames are different. See Table 12-3 for details.

Table 12-3 RTU Length and Function Codes

Function Code	RTU frame length (byte)			Maximum Length(Byte)
	Normal response	Normal response	Abnormal response	
03	8	$5+2N_r^{[4]}$	5	37
41 (06)	8	8	5	8
08	8	8	5	8
42 (10)	$9+2N_w^{[5]}$	8	5	41

[4]: $N_r \leq 16$, indicates the number of registers requested to read;

[5]: $N_w \leq 16$, indicates the number of registers requested to write;

[1]: $N_w + N_r \leq 16$;

12.3.6 CRC Parity

CRC parity is with low byte in the front and the high byte in the back.

Transmitting device calculates CRC value at first and attaches it in the sent message. Receiving device will, upon receipt of the CRC value, calculate it again and compare the calculated value with the received CRC value. If they are not equal, it means that an error has occurred in the transmitting process.

Calculation of CRC parity:

- (1) Define a CRC register and assign an initial value FFFFH.
- (2) Perform xor calculation for the first byte of the sent message, and the value of CRC register, and put the result into CRC register. This starts from the address code, without involving start bit and stop bit.
- (3) Draw and check LSB (the least significant bit of CRC register).
- (4) If LSB is 1, all bits of CRC register will be shifted rightward by one bit and the most significant bit will be supplemented by 0. Perform xor calculation for the value of CRC register and A001H, and put the results in CRC register.
- (5) If LSB is 0, all bits of CRC register will be shifted rightward by one bit and the most significant bit will be supplemented by 0.
- (6) Repeat steps 3, 4 and 5, until 8 times of shifts have been completed.
- (7) Repeat steps 2, 3, 4, 5 and 6, and process the next byte of the sent message, until all bytes of the sent message are processed.
- (8) Calculation completed. The content of CRC register is the value for CRC parity
- (9) In a system where time and resource are limited, better to use the look-up table method to realize CRC parity

CRC simple function is as follows (use C language for programming):

```
unsigned int CRC_Cal_Value(unsigned char *Data, unsigned char Length)
{
```

```
unsigned int crc_value = 0xFFFF;
int i = 0;
while(Length--)
{
    crc_value ^= *Data++;
    for(i=0;i<8;i++)
    {
        if(crc_value & 0x0001)
        {
            crc_value = (crc_value>>1)^ 0xa001;
        }
        else
        {
            crc_value = crc_value>>1;
        }
    }
}
return(crc_value);
}
```

The contents above illustrate CRC parity theory. It takes a long time for execution with this method, especially when the parity data is long. Therefore, use the following two loop-up table methods for 16-bit and 8-bit controllers

- CRC16 look-up table for 8-bit processor: the finally returned result of this program is with high byte in the front, so please reverse it while sending)

```
const Uint8 crc_1_tab[256] = {
0x00,0xC1,0x81,0x40,0x01,0xC0,0x80,0x41,0x01,0xC0,0x80,0x41,0x00,0xC1,0x81,0x40,
0x01,0xC0,0x80,0x41,0x00,0xC1,0x81,0x40,0x00,0xC1,0x81,0x40,0x01,0xC0,0x80,0x41,
0x01,0xC0,0x80,0x41,0x00,0xC1,0x81,0x40,0x00,0xC1,0x81,0x40,0x01,0xC0,0x80,0x41,
0x00,0xC1,0x81,0x40,0x01,0xC0,0x80,0x41,0x01,0xC0,0x80,0x41,0x00,0xC1,0x81,0x40,
```

```

0x01,0xC0,0x80,0x41,0x00,0xC1,0x81,0x40,0x00,0xC1,0x81,0x40,0x01,0xC0,0x80,0x41,
0x00,0xC1,0x81,0x40,0x01,0xC0,0x80,0x41,0x01,0xC0,0x80,0x41,0x00,0xC1,0x81,0x40,
0x00,0xC1,0x81,0x40,0x01,0xC0,0x80,0x41,0x01,0xC0,0x80,0x41,0x00,0xC1,0x81,0x40,
0x01,0xC0,0x80,0x41,0x00,0xC1,0x81,0x40,0x00,0xC1,0x81,0x40,0x01,0xC0,0x80,0x41,
0x01,0xC0,0x80,0x41,0x00,0xC1,0x81,0x40,0x00,0xC1,0x81,0x40,0x01,0xC0,0x80,0x41,
0x00,0xC1,0x81,0x40,0x01,0xC0,0x80,0x41,0x01,0xC0,0x80,0x41,0x00,0xC1,0x81,0x40,
0x01,0xC0,0x80,0x41,0x00,0xC1,0x81,0x40,0x00,0xC1,0x81,0x40,0x01,0xC0,0x80,0x41,
0x00,0xC1,0x81,0x40,0x01,0xC0,0x80,0x41,0x01,0xC0,0x80,0x41,0x00,0xC1,0x81,0x40,
0x01,0xC0,0x80,0x41,0x00,0xC1,0x81,0x40,0x00,0xC1,0x81,0x40,0x01,0xC0,0x80,0x41,
0x01,0xC0,0x80,0x41,0x00,0xC1,0x81,0x40,0x00,0xC1,0x81,0x40,0x01,0xC0,0x80,0x41,
0x01,0xC0,0x80,0x41,0x00,0xC1,0x81,0x40,0x00,0xC1,0x81,0x40,0x01,0xC0,0x80,0x41,
0x00,0xC1,0x81,0x40,0x01,0xC0,0x80,0x41,0x01,0xC0,0x80,0x41,0x00,0xC1,0x81,0x40
};

```

```

const Uint8 crc_h_tab[256] = {
0x00,0xC0,0xC1,0x01,0xC3,0x03,0x02,0xC2,0xC6,0x06,0x07,0xC7,0x05,0xC5,0xC4,0x04,
0xCC,0x0C,0x0D,0xCD,0x0F,0xCF,0xCE,0x0E,0x0A,0xCA,0xCB,0x0B,0xC9,0x09,0x08,0xC8,
0xD8,0x18,0x19,0xD9,0x1B,0xDB,0xDA,0x1A,0x1E,0xDE,0xDF,0x1F,0xDD,0x1D,0x1C,0xDC,
0x14,0xD4,0xD5,0x15,0xD7,0x17,0xD6,0xD2,0x12,0x13,0xD3,0x11,0xD1,0xD0,0x10,
0xF0,0x30,0x31,0xF1,0x33,0xF3,0xF2,0x32,0x36,0xF6,0xF7,0x37,0xF5,0x35,0x34,0xF4,
0x3C,0xFC,0xFD,0x3D,0xFF,0x3F,0x3E,0xFE,0xFA,0x3A,0x3B,0xFB,0x39,0xF9,0xF8,0x38,
0x28,0xE8,0xE9,0x29,0xEB,0x2B,0x2A,0xEA,0xEE,0x2E,0x2F,0xEF,0x2D,0xED,0xEC,0x2C,
0xE4,0x24,0x25,0xE5,0x27,0xE7,0xE6,0x26,0x22,0xE2,0xE3,0x23,0xE1,0x21,0x20,0xE0,
0xA0,0x60,0x61,0xA1,0x63,0xA3,0xA2,0x62,0x66,0xA6,0xA7,0x67,0xA5,0x65,0x64,0xA4,
0x6C,0xAC,0xAD,0x6D,0xAF,0x6F,0x6E,0xAE,0xAA,0x6A,0x6B,0xAB,0x69,0xA9,0xA8,0x68,
0x78,0xB8,0xB9,0x79,0xBB,0x7B,0x7A,0xBA,0xBE,0x7E,0x7F,0xBF,0x7D,0xBD,0xBC,0x7C,
0xB4,0x74,0x75,0xB5,0x77,0xB7,0xB6,0x76,0x72,0xB2,0xB3,0x73,0xB1,0x71,0x70,0xB0,
0x50,0x90,0x91,0x51,0x93,0x53,0x52,0x92,0x96,0x56,0x57,0x97,0x55,0x95,0x94,0x54,
0x9C,0x5C,0x5D,0x9D,0x5F,0x9F,0x9E,0x5E,0x5A,0x9A,0x9B,0x5B,0x99,0x59,0x58,0x98,
0x88,0x48,0x49,0x89,0x4B,0x8B,0x8A,0x4A,0x4E,0x8E,0x8F,0x4F,0x8D,0x4D,0x4C,0x8C,

```

```
0x44,0x84,0x85,0x45,0x87,0x47,0x46,0x86,0x82,0x42,0x43,0x83,0x41,0x81,0x80,0x40
```

```
};
```

```
Uint16CRC(Uint8 * buffer, Uint8 crc_len)
```

```
{  
    Uint8  crc_i,crc_lsb,crc_msb;  
    Uint16 crc;  
    crc_msb = 0xFF;  
    crc_lsb = 0xFF;  
    while(crc_len--)  
    {  
        crc_i = crc_lsb ^ *buffer;  
        buffer ++;  
        crc_lsb = crc_msb ^ crc_l_tab[crc_i];  
        crc_msb = crc_h_tab[crc_i];  
    }  
    crc = crc_msb;  
    crc = (crc << 8) + crc_lsb;  
    return crc;  
}
```

- CRC16 look-up table for 16-bit processor: the finally returned result of this program is with high byte in the front, so please reverse it while sending.)

```
const Uint16 crc_table[256] = {  
0x0000,0xC1C0,0x81C1,0x4001,0x01C3,0xC003,0x8002,0x41C2,0x01C6,0xC006  
,0x8007,0x41C7,0x0005,0xC1C5,0x81C4,0x4004,0x01CC,0xC00C,0x800D,0x41CD  
,0x000F,0xC1CF,0x81CE,0x400E,0x000A,0xC1CA,0x81CB,0x400B,0x01C9,0xC009  
,0x8008,0x41C8,0x01D8,0xC018,0x8019,0x41D9,0x001B,0xC1DB,0x81DA,0x401A  
,0x001E,0xC1DE,0x81DF,0x401F,0x01DD,0xC01D,0x801C,0x41DC,0x0014,0xC1D4  
,0x81D5,0x4015,0x01D7,0xC017,0x8016,0x41D6,0x01D2,0xC012,0x8013,0x41D3  
,0x0011,0xC1D1,0x81D0,0x4010,0x01F0,0xC030,0x8031,0x41F1,0x0033,0xC1F3
```

```
,0x81F2,0x4032,0x0036,0xC1F6,0x81F7,0x4037,0x01F5,0xC035,0x8034,0x41F4
,0x003C,0xC1FC,0x81FD,0x403D,0x01FF,0xC03F,0x803E,0x41FE,0x01FA,0xC03A
,0x803B,0x41FB,0x0039,0xC1F9,0x81F8,0x4038,0x0028,0xC1E8,0x81E9,0x4029
,0x01EB,0xC02B,0x802A,0x41EA,0x01EE,0xC02E,0x802F,0x41EF,0x002D,0xC1ED
,0x81EC,0x402C,0x01E4,0xC024,0x8025,0x41E5,0x0027,0xC1E7,0x81E6,0x4026
,0x0022,0xC1E2,0x81E3,0x4023,0x01E1,0xC021,0x8020,0x41E0,0x01A0,0xC060
,0x8061,0x41A1,0x0063,0xC1A3,0x81A2,0x4062,0x0066,0xC1A6,0x81A7,0x4067
,0x01A5,0xC065,0x8064,0x41A4,0x006C,0xC1AC,0x81AD,0x406D,0x01AF,0xC06F
,0x806E,0x41AE,0x01AA,0xC06A,0x806B,0x41AB,0x0069,0xC1A9,0x81A8,0x4068
,0x0078,0xC1B8,0x81B9,0x4079,0x01BB,0xC07B,0x807A,0x41BA,0x01BE,0xC07E
,0x807F,0x41BF,0x007D,0xC1BD,0x81BC,0x407C,0x01B4,0xC074,0x8075,0x41B5
,0x0077,0xC1B7,0x81B6,0x4076,0x0072,0xC1B2,0x81B3,0x4073,0x01B1,0xC071
,0x8070,0x41B0,0x0050,0xC190,0x8191,0x4051,0x0193,0xC053,0x8052,0x4192
,0x0196,0xC056,0x8057,0x4197,0x0055,0xC195,0x8194,0x4054,0x019C,0xC05C
,0x805D,0x419D,0x005F,0xC19F,0x819E,0x405E,0x005A,0xC19A,0x819B,0x405B
,0x0199,0xC059,0x8058,0x4198,0x0188,0xC048,0x8049,0x4189,0x004B,0xC18B
,0x818A,0x404A,0x004E,0xC18E,0x818F,0x404F,0x018D,0xC04D,0x804C,0x418C
,0x0044,0xC184,0x8185,0x4045,0x0187,0xC047,0x8046,0x4186,0x0182,0xC042
,0x8043,0x4183,0x0041,0xC181,0x8180,0x4040};
```

```
Uint16 CRC16(Uint16 *msg , Uint16 len){
    Uint16 crcL = 0xFF , crcH = 0xFF;
    Uint16 index;
    while(len--){
        index = crcL ^ *msg++;
        crcL = ((crc_table[index] & 0xFF00) >> 8) ^ (crcH);
        crcH = crc_table[index] & 0xFF;
    }
    return (crcH<<8) | (crcL);
}
```

12.3.7 Abnormal Information Response

Master wants to receive a normal response after it sends a request to slave. Inquiry of master may results in the following four response situations:

- If slave has received a request without communication error and can handle the inquiry normally, slave will return a normal response;
- If slave has not received the request due to communication error, slave cannot return information. Slave will be seen as overtime;
- If slave has received the request but detected a communication error (for example parity, address, frame error), it will not return a response. Slave will be sited as overtime;
- If slave has received the request without communication error but can not handle it (example: request to read a register which does not exist), it will return an abnormal response to report the actual situation of the error to master

An abnormal response message has two fields that are different from the normal response:

- Function code field: in normal response, slave copies the original request function code from the appropriate function code field. MSB of all the function code is zero. In abnormal response, MSB of slave function code is 1.
Abnormal response function code = normal function code +0x80
- Data Field: A slave can return data in the data field in normal response and return abnormal code in abnormal response. See Table 12-4 for definitions of exceptional codes.

Table 12-4 Definitions of Exceptional Codes

Exceptional Code	Name	Definitions
01H	Illegal function	The function code received by slave exceeds the configured scope (refer to 12.3.3 Function Code)
02H	Illegal data address	The data address received by slave (inverter) is not a permitted address; especially, the combination of the start address and transmission length of the register is invalid

		(refer to 12.3.4 Allocation of Register Address).
03H	Illegal data frame	As detected by slave (inverter), the inquiry data frame length or CRC parity is incorrect
04H	Slave fault	Unrecoverable mistake happened when slave (inverter) tries to execute require operation. The cause may include logic error or failure to write EEPROM.
05H	Data exceeding the range	Data received by slave (inverter) exceeds the scope of corresponding register: minimum - maximum.
06H	Parameter: read only	The present register is read only and can not be written
07H	Parameter: not modified during running	Inverter is in running status. The present register can not be written. If necessary, please stop inverter at first.
08H	Parameter: password protection	The present register is password protected.

12.4 Protocol Description

12.4.1 Definitions of Time Interval of Interframe and Intraframe Time Interval

A complete MODBUS message includes not only the required data unit, but also start and end marks. Therefore, as indicated in Figure 12-1 and Figure 12-3, an idle level with the transmission time equal to or greater than 3.5 characters is defined as the start mark, and the transmission will be deemed as abnormal if there is an idle level with transmission time greater than 1.5 characters during the message transmission.

Specific start-end and abnormal interval time have something to do with bit rate (refer to Table 12-5). If the bit rate is 9,600 bps, with sampling period of 1ms, then the start-end interval is an idle level greater than or equal to 4ms ($3.5 \times 10 / 9600 = 3.64 \approx 4$), the interval of exceptional data is the idle level with interval time among bits of one data frame greater than or equal to 2ms ($1.5 \times 10 / 9600 = 1.56 \approx 2$) but smaller than 4ms (idle level between normal data bits less than or equal to 1 ms)

Table 12-5 Checklist of Time Interval and Bit Rate (when $t_{\text{modify}}=1$ ms)

Bit rate (bps)	Start-end interval T_{interval} (t_{modify})	Abnormal interval T_{abnormal} (t_{modify})	Remarks
4800	8	4	Normal frame permits the idle point level ≤ 3 ms; when an idle level ≥ 8 ms, it means the end of a data frame.

9600	4	2	Normal frame permits the idle point level $\leq 1\text{ms}$; when an idle level $\geq 4\text{ms}$, it means the end of a data frame.
19200	2	1	Normal frame permits the idle point level $< 1\text{ms}$; when an idle level $\geq 2\text{ms}$, it means the end of a data frame.
Higher	1	1	An idle level of 1ms means the end of a data frame.

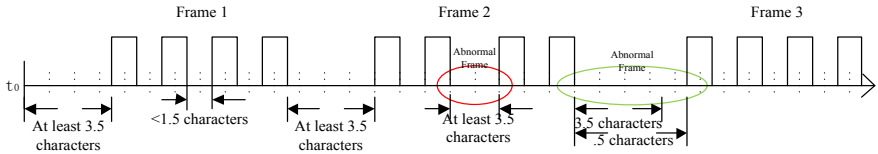

Figure 12-3 Correct and Incorrect Data Frames

12.4.2 Data Frame Processing

After receiving a data frame, the system should process it first to judge whether it is a legal frame sent to inverter. Then, check whether the data is correct and perform corresponding processing. If the received frame is illegal, it will not turn data; if the received frame is legal but incorrect, it will turn corresponding abnormality information frame.

Legal frame: meet address (inverter or broadcast) and length (not less than 3) conditions

Correct frame: a correct frame is a legal frame, of which corresponding memory address is corrected, memory content is as defined and can be processed for the time being.

12.4.3 Modbus Response Delay

Define the time interval from the receipt of a valid data frame ^[1] (data on RS-485 network, different from the command sent by the keyboard), to data learning, and then to starting the data return, as the response delay (set through F10.04). Since a standard protocol has defined the start and end marks, there must be response delay, at least 3.5 character time interval + 1ms (485 protocol chip stable time, t_{w2}), and the specific minimum time interval has something to do with the bit rate. If bit rate is 9600 bps, the minimum response delay shall be 5 ms ($3.5 \times 10 / 9600 + 1 = 4.64 \approx 5$).

If the communication data involves the EEPROM operation, the actual time interval will be extended

[7]: Valid data frame: sent by the external master (other than the keypad) to inverter, and the function code, data length and CRC are correct

As shown in Figure 12-4, data sending section (t_s), sending end mark section (t_{w1}), 75176 forwarding waiting section (t_{w2}), data return section (t_r) and 75176 receipt section

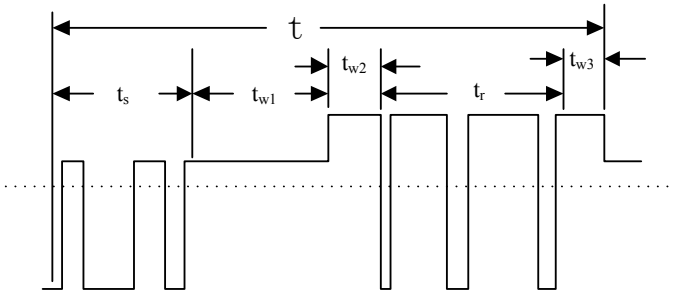

Figure 12-4 Time Sequence Translation of Complete Data Frame

12.4.4 Communication Overtime

Communication interval Δt refers to the period from the previous receipt of a valid data frame by slave (inverter) to the receipt of a valid data frame again. If Δt is greater than the set time (see F10.03; this function is disabled if it is set as 0), this is called “communication overtime”

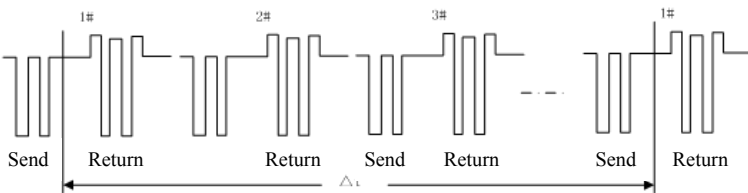

Figure 12-5485 Network Link Data

12.5 Example

1) Inverter forward

Send: 01 41 70 0000 01 E6 C5

Return: 01 41 70 0000 01 E6 C5 (Normal)

Return: 01 C1 04 70 53 (When abnormal, assuming that slave fails)

	Send	Normal return			Abnormal return	
*	Frame header	≥3.5 idle characters				
1	Address	01	Address	01	Address	01
2	Function Code	41	Function Code	41	Function Code	C1
3	Register Address Hi	70	Register Address Hi	70	Exceptional	04(assumpti
4	Register Address Lo	00	Register Address Lo	00	CRC Parity Lo	70
5	Register Value Hi	00	Register Value Hi	00	CRC Parity Hi	53
6	Register Value Lo	01	Register Value Lo	01		
7	CRC Parity Lo	E6	CRC Parity Lo	E6		
8	CRC Parity Hi	C5	CRC Parity Hi	C5		
*	Frame End	≥3.5 idle characters				

2) Inverter coast to stop

Send: 01 41 70 0000 07 66 C7

Return: 01 41 70 0000 07 66 C7 (Normal)

Return: 01 C1 04 70 53 (When abnormal, assuming that slave fails)

	Send	Normal return			Abnormal return	
*	Frame Header	≥3.5 idle characters				
1	Address	01	Address	01	Address	01
2	Function Code	41	Function Code	41	Function Code	C1
3	Register Address Hi	70	Register Address Hi	70	Exceptional Code	04(assumpti on)
4	Register Address Lo	00	Register Address Lo	00	CRC Parity Lo	70
5	Register Value Hi	00	Register Value Hi	00	CRC Parity Hi	53
6	Register Value Lo	07	Register Value Lo	07		

EM500 Open-Loop Vector Control Inverter User Manual

7	CRC Parity Lo	66	CRC Parity Lo	66	
8	CRC Parity Hi	C7	CRC Parity Hi	C7	
*	Frame End	≥3.5 idle characters			

Change the setting frequency (for example 50.00 Hz/1388 H) (F00.04=7)

Send: 01 41 70 15 13 88 3B 97

Return: 01 41 70 15 13 88 3B 97 (Normal)

Return: 01 C1 04 70 53 (When abnormal, assuming that slave fails)

	Send	Normal return			Abnormal return	
*	Frame Header	≥3.5 idle characters				
1	Address	01	Address	01	Address	01
2	Function Code	41	Function Code	41	Function Code	C1
3	Register Address Hi	70	Register Address Hi	70	Exceptional Code	04(assumption)
4	Register Address Lo	15	Register Address Lo	15	CRC Parity Lo	70
5	Register Value Hi	13	Register Value Hi	13	CRC Parity Hi	53
6	Register Value Lo	88	Register Value Lo	88		
7	CRC Parity Lo	3B	CRC Parity Lo	3B		
8	CRC Parity Hi	97	CRC Parity Hi	97		
*	Frame End	≥3.5 idle characters				

1) Read the last fault information (read F19.00 - F19.05)

Send: 01 03 13 00 00 06 C1 4C

Return: 01 03 0C 00 11 00 00 00 01 2C 00 00 00 0053 5B (Normal)

Return: 01 83 04 40 F3 (When abnormal, assuming that slave fails)

	Send	Normal return			Abnormal return	
*	Frame Header	≥3.5 idle characters				
1	Address	01	Address	01	Address	01
2	Function Code	03	Function Code	03	Function Code	83
3	Initial Address Hi	13	Number of Bytes	0C	Exceptional Code	04(assumption)
4	Initial Address Lo	00	Register Value Hi (F19.00)	00	CRC Parity Lo	40
5	Number of Registers Hi	00	Register Value Lo (F19.00)	11	CRC Parity Hi	F3

EM500 Open-Loop Vector Control Inverter User Manual

6	Number of Registers Lo	06	Register Value Hi (F19.01)	00	
7	CRC Parity Lo	C1	Register Value Lo (F19.01)	00	
8	CRC Parity Hi	4C	Register Value Hi (F19.02)	00	
9			Register Value Lo (F19.02)	00	
10			Register Value Hi (F19.03)	01	
11			Register Value Lo (F19.03)	2C	
12			Register Value Hi (F19.04)	00	
13			Register Value Lo (F19.04)	00	
14			Register Value Hi (F19.05)	00	
15			Register Value Lo (F19.05)	00	
16			CRC Parity Lo	53	
17			CRC Parity Hi	5B	
*	Frame End	≥3.5 idle characters			

2) Check whether the lines work

Send: 01 08 00 00 AA 55 5E 94

Return: 01 08 00 00 AA 55 5E 94 (Normal)

Return: 01 88 04 47 C3 (When abnormal, assuming that slave fails)

	Send	Normal return			Abnormal return	
*	Frame Header	≥3.5 idle characters				
1	Address	01	Address	01	Address	01
2	Function	08	Function	08	Function Code	88
3	Sub-Function Code Hi	00	Sub-Function Code Hi	00	Exceptional	04(assumpti
4	Sub-Function Code	00	Sub-Function Code Lo	00	CRC Parity Lo	47

	Lo					
5	Data Hi	AA	Data Hi	AA	CRC Parity Hi	C3
6	Data Lo	55	Data Lo	55		
7	CRC Parity Lo	5E	CRC Parity Lo	5E		
8	CRC Parity Hi	94	CRC Parity Hi	94		
*	Frame End	≥3.5 idle characters				

3) Change carrier frequency (F00.23) to 4.0 kHz. (Since such function codes are expected to be saved in EEPROM usually after change, the function code 0x06 is used hereby).

Send: 01 06 00 17 00 28 39 D0

Return: 01 06 00 17 00 28 39 D0 (Normal)

Return: 01 86 04 43 A3 (When abnormal, assuming that slave fails)

	Send	Normal return			Abnormal return	
*	Frame Header	≥3.5 idle characters				
1	Address	01	Address	01	Address	01
2	Function Code	06	Function Code	06	Function Code	86
3	Register Address Hi	00	Register Address Hi	00	Exceptional	04(assumpti
4	Register Address Lo	17	Register Address Lo	17	CRC Parity Lo	43
5	Register Value Hi	00	Register Value Hi	00	CRC Parity Hi	A3
6	Register Value Lo	28	Register Value Lo	28		
7	CRC Parity Lo	39	CRC Parity Lo	39		
8	CRC Parity Hi	D0	CRC Parity Hi	D0		
*	Frame End	≥3.5 idle characters				

13. CANSine Communication Protocol

13.1 Application Scope

1. Applicable series: EM500
2. Applicable network: Inverter with CAN bus interface - Inverter master-slave communication, and communication between client and inverter

13.2 Physical Interfaces

13.2.1 Bus topology

CAN bus connection topology as shown below, CAN bus recommended shielded twisted pair connection, the bus ends are connected to two 120Ω termination resistor to prevent signal reflection. Shield generally use a single point of reliable grounding.

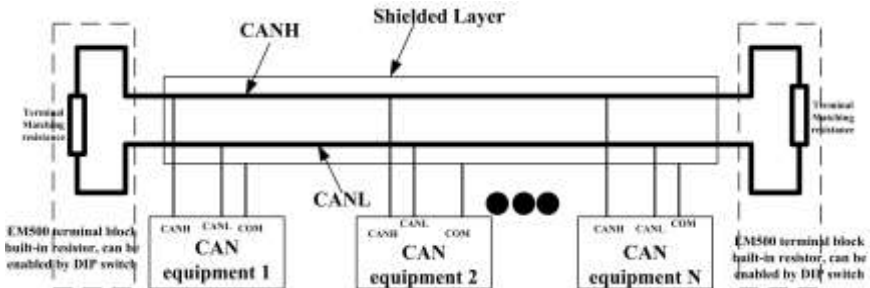

Figure 13- 1 CAN bus topology diagram

13.2.2 Baud rate and transmission distance

The maximum length of the CAN bus depends on the communication speed, Specific provisions are as follows:

Baud rate	Maximum length of the bus	Baud rate	Maximum length of the bus
1Mbit/s	25m	125 kbit/s	500m
800 kbit/s	50m	50 kbit/s	1000m
500 kbit/s	100m	20 kbit/s	2500m
250 kbit/s	250m	10 kbit/s	5000m

13.3 Protocol Format

13.3.1 Standard frame format

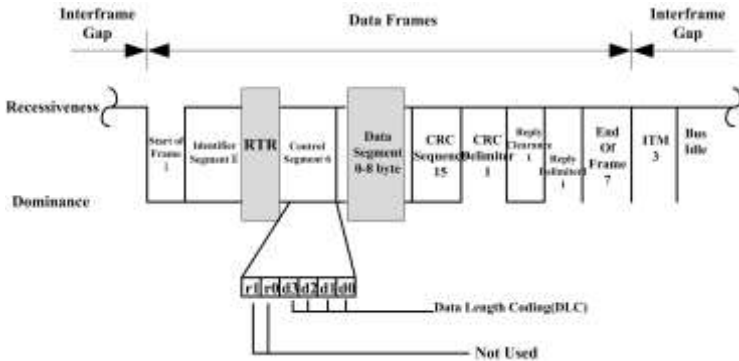

A **frame header** is used to indicate the beginning of a data frame or remote frame, as a definite dominant bit.

In the standard format data frame, **the identifier** (CAN-ID) is composed of 11 bits, which is used to indicate the determined message to be transmitted. Its value is also the priority of the message to be transmitted.

After the identifier is a **remote transmission request** bit, used to distinguish between data frames and remote frames, when the bit is dominant, that the transmission of data frames, as recessive, said the transmission of remote frames.

The control segment (DLC) consists of 6 bits, including reserved bits r1, r0, and 4-bit

DLC data length codes, in the range 0 to 8, which can also be transmitted on the bus when the DLC value is greater than 8. The number of bytes transferred in the data field for this frame is still limited to 8 bytes.

The data segment consists of 0 to 64 bits and contains the actual valid information (0-8 bytes) for this frame transmission.

The data segment is followed by a **CRC segment** consisting of a 15-bit CRC sequence and a 1-bit CRC delimiter. The receiver may use the CRC sequence to identify whether or not erroneous data has been accepted.

The acknowledgment segment consists of an acknowledge slot bit and an acknowledge delimiter bit. The transmitter transmits a recessive level at the acknowledge slot; after receiving the complete message correctly, the receiver sends a dominant level for acknowledgment.

By the **end of the frame** composed of seven recessive level.

13. 3. 2 Protocol content

In the standard frame of a frame of data, users only need to focus on the contents of the **identifier**, **control section** and **the data segment**. The definition data format is as follows:

Identifier	Control Domain	Data Field (16bit)			
Function code + slave address	Data length	Data 1	Data 2	Data 3	Data 4

The 11-bit identifier consists of a **4-bit function code** and a **7-bit node address**. The node address ranges from 0 to 127, where 0 is the broadcast address. 127 for the host address, the specific function code is defined in the table below.

Function	Function code	Abnormal code	CAN - ID range (point-to-point)
----------	---------------	---------------	---------------------------------

Read the register or status word	0x200	0x280	201h~27Fh
Write register or command, no save EEP	0x400	0x480	401h~47Fh
Write register or command, Save EEP	0x600	0x680	601h~67Fh
Diagnostic function code	0x700	0x780	701h~78Fh

The content of the control field is the valid data length, and each frame contains up to 8 bytes of valid data. For EM500 inverter, the register address value and the register data length are both 16 bits, or 2 bytes. The slave device needs to occupy a fixed 2 bytes when data is restored. Therefore, **the CAN protocol can read up to 3 register values per frame. write 2 registers values.**

After the slave receives the data sent from the host and parses it, it needs to return the data to the host. Specifies that the first two bytes of slave response data are **slave address + exception code (normally 0)**. The function codes and the slave response data are described in detail below.

13. 3. 2. 1 Read register or status word function code (0x200)

The function code is used to read the contents of the register, the request message describes the register address, the normal state response message is register data, the high byte first. This function code can read up to 3 registers at a time.

- request message

CAN-ID	0x200+slave address
DLC (Date Length)	2*N
Data Field	N*2 Bytes

- Response message

CAN-ID	0x200+ Host address
DLC (Date Length)	2+2*N
Data Field	2+N*2 Bytes

● Error message

CAN-ID	0x200+ Host address
DLC (Data Length)	2
Data Field	Slave address+ Abnormal code

The following is an example of a request to read the device register F18.00 (output frequency) F18.06 (output current) F18.08 (output voltage) with address 1:

request		Response			
Domain Name	(hexadecimal)	Domain Name (normal)	(hexadecimal)	Domain Name (Abnormal)	(hexadecimal)
CAN-ID	201	CAN-ID	27F	CAN-ID	2FF
Date Length	06	Date Length	08	Date Length	02
Register address Hi	12	Slave address	01	Slave address	01
Register address Lo	00	Abnormal code	00	Abnormal code	05 (Example, the same below)
Register address Hi	12	Register values Hi	00		
Register address Lo	06	Register values Lo	00		
Register address Hi	12	Register values Hi	00		

Register address Lo	08	Register values Lo	00	
		Register values Hi	00	
		Register values Lo	00	

13.3.2.2 Write register or command function code, (0x400 ,no save EEPROM)

The function code is used to write the non-holding register. The request message is the address and value to be written to the register. The normal status response message is the slave address + exception code. The function code can write up to two registers at a time.

- request message

CAN-ID	0x400+slave address
DLC (Data Length)	4*N
Data Field	N*4 Bytes

- Response message

CAN-ID	0x400+ Host address
DLC (Data Length)	2
Data Field	Slave address+ Abnormal code(00)

- Error message

CAN-ID	0x480+ Host address
DLC (Data Length)	2
Data Field	Slave address+ Abnormal code

The following is an example of a device operating at address 1 running at a frequency of 100% (7001H) forward running (7000H):

request		Response			
Domain Name	(hexadecimal)	Domain Name (normal)	(hexadecimal)	Domain Name (Abnormal)	(hexadecimal)

EM500 Open-Loop Vector Control Inverter User Manual

				l)	
CAN-ID	401	CAN-ID	47F	CAN-ID	4FF
Date Length	08	Date Length	02	Date Length	02
Register address Hi	70	Slave address	01	Slave address	01
Register address Lo	00	Abnormal code	00	Abnormal code	05
Register Values Hi	00				
Register Values Lo	01				
Register address Hi	70				
Register address Lo	01				
Register Values Hi	27				
Register Values Lo	10				

13.3.2.3 Write register or command function code, (0x600 , save EEPROM)

The function code is used to write the non-holding register. The request message is the address and value to be written to the register. The normal status response message is the slave address + exception code. The function code can write up to two registers at a time.

- request message

CAN-ID	0x600+slave address
DLC (Date Length)	4*N
Data Field	N*4 Bytes

- Response message

CAN-ID	0x600+ Host address
DLC (Date Length)	2
Data Field	Slave address+ Abnormal code(00)

- Error message

CAN-ID	0x680+ Host address
DLC (Date Length)	1
Data Field	Slave address+ Abnormal code

The following is an example of changing the device maximum frequency (F00.16) at address 1 to 50.00Hz:

request		Response			
Domain Name	(hexadecimal)	Domain Name (normal)	(hexadecimal)	Domain Name (Abnormal)	(hexadecimal)
CAN-ID	601	CAN-ID	67F	CAN-ID	6FF
Date Length	04	Date Length	02	Date Length	02
Register address Hi	00	Slave address	01	Slave address	01

Register address Lo	10	Abnormal code	00	Abnormal code	05
Register Values Hi	13				
Register Values Lo	88				

13.2.2.4 Diagnostic function code (0x700)

The function code is used to check whether the communication between the master and the slave is normal. The host sends any 2-byte contents. The normal status response packet is the slave address + exception code, and the contents are copied.

- request message

CAN-ID	0x700+slave address
DLC (Date Length)	2
Data Field	2 Bytes

- Response message

CAN-ID	0x700+ Host address
DLC (Date Length)	2
Data Field	Slave address+ Abnormal code(00)

- Error message

CAN-ID	0x780+ Host address
DLC (Date Length)	2
Data Field	Slave address+ Abnormal code

The following is an example of using the diagnostic function code to send data 0x55AA to a device with node address 1:

request		Response			
Domain Name	(hexadecimal)	Domain Name (normal)	(hexadecimal)	Domain Name (Abnormal)	(hexadecimal)
CAN-ID	701	CAN-ID	77F	CAN-ID	7FF
Date Length	02	Date Length	04	Date Length	02
Date Hi	55	Slave address	01	Slave address	01
Date Lo	AA	Abnormal code	00	Abnormal code	05
		Date Hi	55		
		Date Lo	AA		

13.3.3 Register Address Distribution

As same as MODBUS communication protocol register address, See details12.3.4

13.4 Broadcast messages

The EM500 CANSinec protocol supports broadcast transmission of packets. The address of the CAN-ID node that defines the broadcast message is 0, and the slave device does not respond to the packet after receiving the broadcast message.

The application of broadcast message is multi-machine synchronization. That is, multiple inverters are connected to the same network through CAN bus. One of them is used as a host to broadcast commands or parameter values (such as operating frequency) to the network. Synchronous operation.

13.5 Abnormal information response

When the master device sends a request to the slave device, the master station wants to

get a normal response. A query by the master may result in one of the following four times:

- If the slave device receives a request with no communication error and can process the query normally, the slave device will return a normal response.
- If the slave device receives a request for no communication error but can not process the request (such as requesting a non-existent register), the slave will return an exception response informing the master of the actual error.

Exception response message has two different domains to normal response :

- **Function code field:** In the normal response, the slave replicates the function code of the original request in the corresponding function code field. The LSB of the 4-bit function code is 0. In the exception response, the slave sets the LSB of the function code to 1. Namely, **the abnormal response function code = normal response function code +1**
- **Data field:** In the normal response, the slave can return the exception code 00H in the data field. In the abnormal response, the slave returns other exception codes in the data field. The specific exception codes are shown in Table 3- 1

Table 3-1 Definition of abnormal codes

Abnormal code	Name	Implication
00H	normal	The received data from the slave (inverter) can be parsed normally
01H	Illegal function	The function code received by the slave (drive) has exceeded the configured range
02H	Illegal data address	The data address received by the slave (inverter) is not an allowed address; in particular, the combination of the start address and the transfer length of the register is invalid
03H	Illegal data frame	The length of the data received by the slave (inverter) is not correct

<i>04H</i>	Slave device failure	An unrecoverable error occurred while attempting to perform a requested operation on the slave (drive). Possible cause A logical error or a write EEPROM failure
<i>05H</i>	Data out of range	The data received by the slave (inverter) exceeds the minimum to maximum range of the corresponding register
<i>06H</i>	Parameters are read-only	The current register is read-only and can not be written
<i>07H</i>	Parameters can not be changed during operation	The inverter is running, the current register can not be written to, if you need to operate, please stop
<i>08H</i>	Parameters are password protected	The current register is password protected

13.6 Illustrate

1) The inverter is running forward

	Identifiers	Control Field	Date Field			
Send	0x401	04	70 00	00 01		
Response	0x47F	02	01 00			
Response (abnormal)	0x4FF	02	01 04			

(Assuming that the fault is a slave device Error)

Illustrate:

Send		Response		Abnormal Response	
CAN-ID	0x401	CAN-ID	0x47F	CAN-ID	0x4FF
Date Length	04	Date Length	02	Date Length	02
Register address Hi	70	Slave Address	01	Slave Address	01
Register address Lo	00	Abnormal code	00	Abnormal code	04
Register Values Hi	00				
Register Values Lo	01				

2) The inverter stop

	Identifiers	Control Field	Date Field			
Send	0x401	04	70 00	00 00		
Response	0x47F	02	01 00			
Response (abnormal)	0x4FF	02	01 04			

Illustrate:

Send		Response		Abnormal Response	
CAN-ID	0x401	CAN-ID	0x47F	CAN-ID	0x4FF
Date Length	04	Date Length	02	Date Length	02
Register address Hi	70	Slave Address	01	Slave Address	01
Register address Lo	00	Abnormal code	00	Abnormal code	04
Register Values Hi	00				
Register Values Lo	00				

3) change the operating frequency (such as 50.00Hz / 1388H)

	Identifiers	Control Field	Date Field			
--	-------------	---------------	------------	--	--	--

EM500 Open-Loop Vector Control Inverter User Manual

Send	0x401	04	00 07	13 88		
Response	0x47F	02	01 00			
Response (abnormal)	0x4FF	02	01 04			

Illustrate:

Send		Response		Abnormal Response	
CAN-ID	0x401	CAN-ID	0x47F	CAN-ID	0x4FF
Date Length	04	Date Length	02	Date Length	02
Register address Hi	00	Slave Address	01	Slave Address	01
Register address Lo	07	Abnormal code	00	Abnormal code	04
Register Values Hi	13				
Register Values Lo	88				

4) Read the motor operating data (read F18.00, F18.06, F18.08 function code)

	Identifiers	Control Field	Date Field			
Send	0x201	06	1200	1206	1208	
Response	0x27F	08	01 00	13 88	00 E6	02 1C
Response (abnormal)	0x2FF	02	01 04			

Illustrate:

Send		Response		Abnormal Response	
CAN-ID	0x201	CAN-ID	0x47F	CAN-ID	0x4FF
Date Length	06	Date Length	02	Date Length	02
Register address Hi	12	Slave Address	01	Slave Address	01
Register address Lo	00	Abnormal code	00	Abnormal code	04

Register address Hi	12	Register values Hi	13		
Register address Lo	06	Register values Lo	88		
Register address Hi	12	Register values Hi	00		
Register address Lo	08	Register values Lo	E6		
		Register values Hi	02		
		Register values Lo	1C		

5) Check whether the line is connected

	Identifiers	Control Field	Date Field			
Send	0x701	02	55 AA			
Response	0x77F	04	01 00	55 AA		
Response (abnormal)	0x7FF	02	01 04			

Illustrate:

Send		Response		Abnormal Response	
CAN-ID	0x701	CAN-ID	0x77F	CAN-ID	0x7FF
Date Length	02	Date Length	04	Date Length	02
Date Hi	55	Slave Address	01	Slave Address	01
Date Lo	AA	Abnormal code	00	Abnormal code	04
		Date Hi	55		
		Date Lo	AA		

6) Change the carrier frequency (F00.23) to 4.0kHz (because such function code is generally changed to save EEPROM, so use 0x600 function code)

	Identifiers	Control Field	Date Field			
Send	0x601	04	00 17	00 28		
Response	0x67F	02	01 00			

Response (abnormal)	0x6FF	02	01 04			
----------------------------	-------	----	-------	--	--	--

Illustrate:

Send		Response		Abnormal Response	
CAN-ID	0x601	CAN-ID	0x67F	CAN-ID	0x6FF
Date Length	04	Date Length	02	Date Length	02
Register address Hi	00	Slave Address	01	Slave Address	01
Register address Lo	07	Abnormal code	00	Abnormal code	04
Register values Hi	00				
Register values Lo	28				

Appendix I. Multi-Functional IO Expansion Card

(EC-IO-A1)

I.1 General

EC-IO-A1 card is used for EM500 control terminal expansion, including the following resources:

Item	Specification	Description
Input	4 Numeric Multi-function Inputs	
	1 Analog Voltage Signal Input	Support -10V - +10V voltage input or PT100/PT1000 temperature sensor
Output	Numeric Signal Output	

I.2 Installation Instructions

- Install IO expansion card into the expansion slot EC-B (make sure that it is installed and buckled properly).
- Disassemble or install IO expansion card only after inverter is powered off.

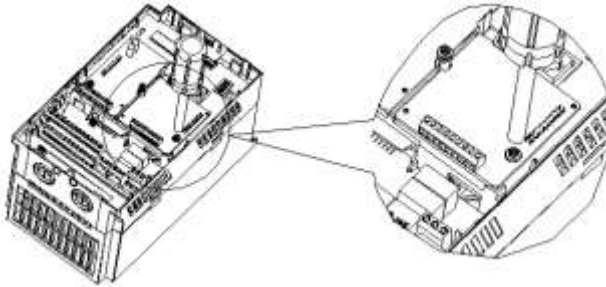

Figure 1 Installation of IO Expansion Card

Point I/O expansion card at interface and location hole of expansion slot, and fix them with screws.

- **Figures of real objects are as follows:**



Elevation



Back Elevation

1. DIP Switch 1 2. DIP Switch 2 3. Analog Signal Interface
 4. Numeric Signal Interface 5. Screw Location Hole 6. Inverter Interface

I.3 Expansion Terminal Function

Table 1 IO Expansion Card Terminal Function

Type	Item	Terminal	Description
Auxiliary Power Supply	24V-COM	+24V Power Supply	Provide a working power supply for numeric input and output terminals
	PLC	Common Multi-function Input Terminal	Default setting: Connecting to 24V power supply When driving the numeric input terminal with external power supply, disconnect it from 24V terminal and connect it to external power supply.
Numeric Input	X8	Multi-function Input Terminal 8	Optocoupler isolation, compatible with bipolar input of NPN and PNP Input impedance: 4.5 kΩ Input voltage range: 9 – 30 V See Table 3-17
	X9	Multi-function Input Terminal 9	
	X10	Multi-function Input Terminal 10	
	X11	Multi-function Input Terminal 11	
Multi-Function Output	Y3-COM	OC Output Terminal	Optocoupler isolation, OC output Maximum output voltage: DC48V Output current: 50 mA
Analog	AI4-GND	Analog Input Terminal 4	Input range: DC -10V - +10V; the voltage

Input			input mode is selected by switch S2 on IO expansion card. Input impedance: Voltage mode 1 MΩ
	PT-GND	Temperature Sensor Input	PT100 and PT1000 Temperature Sensor Input Control mode is selected through switches S2 and S2 on IO expansion card.

Table 2 DIP Switch of IO Expansion Card

S1	S2	Function								
_____	<table border="1"> <tr> <td>DIF</td> <td>PT</td> </tr> <tr> <td>S2</td> <td><input checked="" type="checkbox"/> <input type="checkbox"/></td> </tr> </table>	DIF	PT	S2	<input checked="" type="checkbox"/> <input type="checkbox"/>	AI4 Voltage Input, Enabled PT Input, Disabled				
DIF	PT									
S2	<input checked="" type="checkbox"/> <input type="checkbox"/>									
<table border="1"> <tr> <td>100</td> <td>1000</td> </tr> <tr> <td>S1</td> <td><input checked="" type="checkbox"/> <input type="checkbox"/></td> </tr> </table>	100	1000	S1	<input checked="" type="checkbox"/> <input type="checkbox"/>	<table border="1"> <tr> <td>DIF</td> <td>PT</td> </tr> <tr> <td>S2</td> <td><input type="checkbox"/> <input checked="" type="checkbox"/></td> </tr> </table>	DIF	PT	S2	<input type="checkbox"/> <input checked="" type="checkbox"/>	AI4 Voltage Input, Disabled PT input is through temperature sensor PT100
100	1000									
S1	<input checked="" type="checkbox"/> <input type="checkbox"/>									
DIF	PT									
S2	<input type="checkbox"/> <input checked="" type="checkbox"/>									
<table border="1"> <tr> <td>100</td> <td>1000</td> </tr> <tr> <td>S1</td> <td><input type="checkbox"/> <input checked="" type="checkbox"/></td> </tr> </table>	100	1000	S1	<input type="checkbox"/> <input checked="" type="checkbox"/>	<table border="1"> <tr> <td>DIF</td> <td>PT</td> </tr> <tr> <td>S2</td> <td><input type="checkbox"/> <input checked="" type="checkbox"/></td> </tr> </table>	DIF	PT	S2	<input type="checkbox"/> <input checked="" type="checkbox"/>	AI4 Voltage Input, Disabled PT input is through temperature sensor PT1000
100	1000									
S1	<input type="checkbox"/> <input checked="" type="checkbox"/>									
DIF	PT									
S2	<input type="checkbox"/> <input checked="" type="checkbox"/>									

Appendix II Multi-Functional IO Expansion Card 3 (EC-IO-A3)

II.1 General

EC-IO-A3 card is used for EM500 control terminal expansion, including the following resources:

Item	Specification	Description
Input	1 temperature input	Support PT100, KTY84-130/150 and PTC130/150 temperature sensor
Output	1 relay output (NO)	Y3: EA3-EC3, maximum output current of OC is 50mA; relay contactor capacity: 250VAC/3A or 30VDC/1A
Power Supply	+15V	+15V-GND, max. output current is 100mA

II.2 Installation Instructions

- Install IO expansion card 3 into the expansion slot EC-B (make sure that it is installed and buckled properly).
- Disassemble or install IO expansion card 3 only after inverter is powered off.

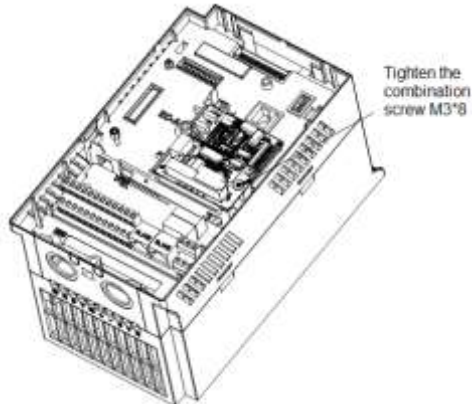

Figure 2 Installation of IO Expansion Card 3

Point I/O expansion card 3 at interface and location hole of expansion slot, and fix them with screws.

- **Figures of real objects are as follows:**



Elevation



Back Elevation

1. DIP Switch 1
2. DIP Switch 2
3. DIP Switch 3
4. Temperature Sensor
5. Power Supply
6. Relay Output
7. Inverter Slot

II.3 Expansion Terminal Function

Table 3 IO Expansion Card 3 Terminal Function

Switch	Function
PT100 S1 <input checked="" type="checkbox"/> ON <input type="checkbox"/> OFF	S1-ON: T1-T2 temperature sensor type: PT100 S2 and S3 should be OFF
KTY84 S2 <input checked="" type="checkbox"/> ON <input type="checkbox"/> OFF	S2-ON: T1-T2 temperature sensor type: KTY84-130 or KTY84-150 S1 and S3 should be OFF
PTC S3 <input checked="" type="checkbox"/> ON <input type="checkbox"/> OFF	S3-ON: T1-T2 temperature sensor type: PTC130 or PTC150 S1 and S2 should be OFF

Appendix III Profibus-DP Expansion Card

(EC-CM-P1)

III.1 General

Communication card EC-CM-P1 is defined as PROFIBUS-DP slave communication card and used to connect EM500 inverter to PROFIBUS-DP network.

Main features:

- Support PZD control data exchange.
- Support PKW access to inverter parameters.
- Support the user diagnosis function.
- Automatic detection of communication rate, up to 12 Mbps.

III.2 Installation Instructions

- Install Profibus-DP expansion card into the expansion slot EC-B (make sure that it is installed and buckled properly).
- Disassemble or install Profibus-DP expansion card only after inverter is powered off.

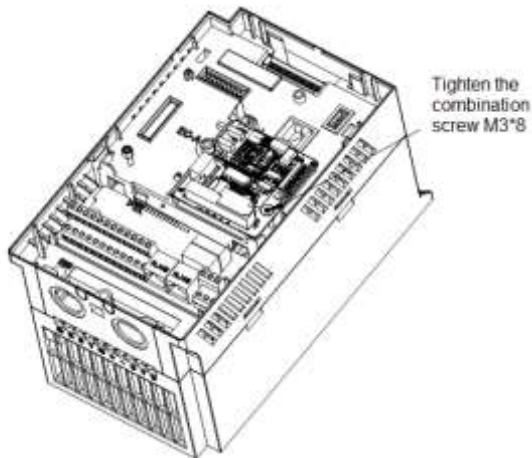
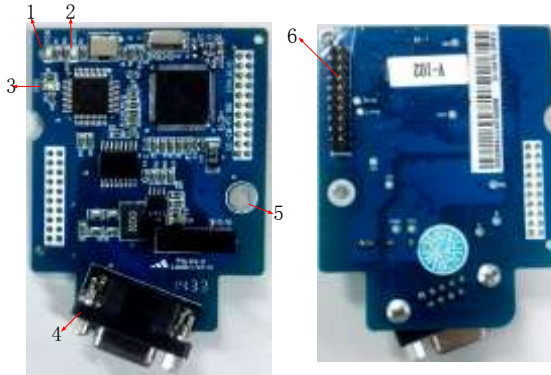

Figure 3 Installation of Profibus-DP expansion card

Point Profibus-DP expansion card at interface and location hole of expansion slot, and fix them with screws.

- **Figures of real objects are as follows:**



Elevation

Back Elevation

- | | | |
|--------------------------|------------------------|-----------------------|
| 1. POWER Indicator | 2. Modbus Indicator | 3. Profibus Indicator |
| 4. Profibus-DP Interface | 5. Screw Location Hole | 6. Inverter Interface |

III.3 Expansion Terminal Function

Table 4 Profibus-DP Expansion Card Terminal Function (Interface Type is DB9)

Type	Item	Terminal	Description
Profibus-DP Communication Terminal	3	Data A	Signal Line (Anode)
	4	RTS	Request for Sending Signal
	5	PGND	Data Signal Ground
	6	P5V	Power
	8	Data B	Signal Line (Cathode)

Table 5 Indicator of Profibus-DP Expansion Card

LED Indicator	Display Function	Description
POW	Power Indicator	The expansion card is connected to inverter normally and this indicator is normally on after inverter is powered on.

MOD	Profibus-DP Expansion Card and Inverter Communication Indicator	“Normally on” status means that DP expansion card and inverter communicate with each other normally. “Off” status means that DP expansion card and inverter fail to communicate with each other.
PRO	Profibus-DP Expansion Card and Profibus Bus Connection Indicator	“Normally on” status means that DP expansion card and bus communicate with each other normally. “Off” status means that DP expansion card and bus fail to communicate with each other.

Table 6 DIP Switch of Profibus-DP Expansion Card

Switch	Function
	Choose terminal resistor

Appendix IV CANopen Expansion Card (EC-CM-C1)

IV.1 General

Communication card EC-CM-P1 is defined as CANOPEN slave communication card and used to connect EM500 inverter to CANOPEN network.

Main features:

- It supports Node Guard protocol and master can use this function to view device status.
- It supports Heartbeat protocol, with which slave reports present status to master regularly.
- It supports NMT network management protocol, with which inverter receives the message for inverter status control by master and changes its own communication status.
- SDO only supports accelerated sending mechanism, up to 4 bytes in transmission, and can be used to read and write device parameters.
- PDO supports 4 groups and user may select 1 group randomly; this can be used to transmit the data required for real time transmission in the transmission communication process, up to 4 bytes for each frame.

IV.2 Installation Instructions

- Install CANopen expansion card into the expansion slot EC-B (make sure that it is installed and buckled properly).
- Disassemble or install CANopen expansion card only after inverter is powered off.

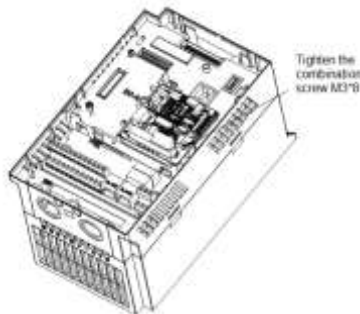
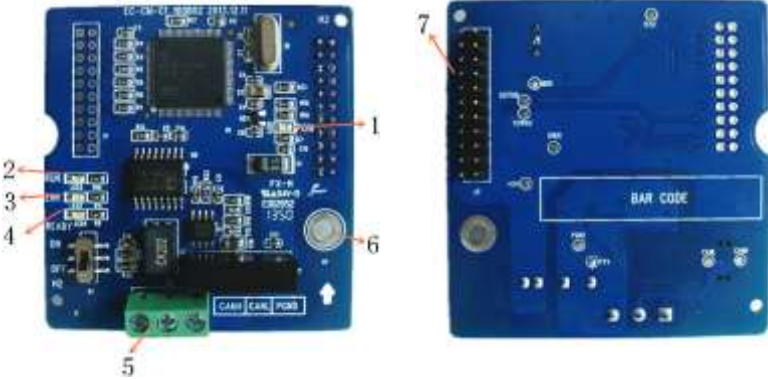

Figure 4 CANopen Expansion Card Installation

Point CANopen expansion card at interface and location hole of expansion slot, and fix them with screws.

- **Figures of real objects are as follows:**



Elevation

Back Elevation

1. POWER Indicator 2. RUN Indicator 3. ERR Indicator
 4. READY Indicator 5. CANopen Interface 6. Screw Location Hole
 7. Inverter Interface

IV.3 Expansion Terminal Function

Table 7 CANopen Expansion Card Terminal Function

Type	Item	Terminal	Description
CANopen Communication Terminal	1	CANH	Signal Line (Anode)
	2	CANL	Signal Line (Cathode)
	3	PGND	Signal Ground

Table 8 CANopen Expansion Card Indicator

Communication Card	READY (Green)	ERR (Red)	RUN (Green)
Initialization Status	ON	OFF	OFF
Pre-operation Status	ON	OFF	Rapid Flicker
Operation Status	ON	OFF	

Stop Status	ON	OFF	
Modbus Fault	ON	Slow Flicker	OFF
CANopen Fault	ON	ON	OFF
Factory Inspection	ON	ON	ON

Table 9 Flicker of CANopen Expansion Card Indicator



Definition of Flicker	Description
Rapid Flicker	
Slow flicker	

Table 10 DIP Switch of CANopen Expansion Card

Switch	Function
<div style="display: flex; align-items: center;"> <div style="margin-right: 10px;"> <input type="checkbox"/> ON <input type="checkbox"/> OFF </div> <div style="margin-right: 10px;"> <input checked="" type="checkbox"/> </div> <div style="margin-right: 10px;"> <input type="checkbox"/> </div> <div style="margin-right: 10px;">S1</div> </div>	Select a terminal resistor

Appendix V DeviceNet Expansion Card (EC-CM-D1)

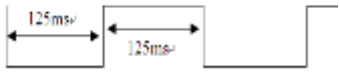
V.1 General

Communication card EC-CM-D1 is defined as DeviceNet slave communication card and used to connect EM500 inverter to DeviceNet network.

1. Support the connection mode “Group 2 only” of DeviceNet communication protocol, and support I/O polling data exchange.
2. I/O mapping supports up to 16-byte input and 16-byte output.
3. Support three communication rates via DeviceNet bus, respectively 125 kbps, 250 kbps and 500 kbps.
4. Support direct setting of node address and communication rate on inverter.
5. Automatically obtain the power from inverter.
6. Monitor inverter in real time based upon the high-speed communication port of SINEE Modbus communication protocol.

V.2 Installation Instructions

- Install DeviceNet card into the expansion slot EC-A (make sure that it is installed and buckled properly).
- Disassemble or install DeviceNet card only after inverter is powered off.

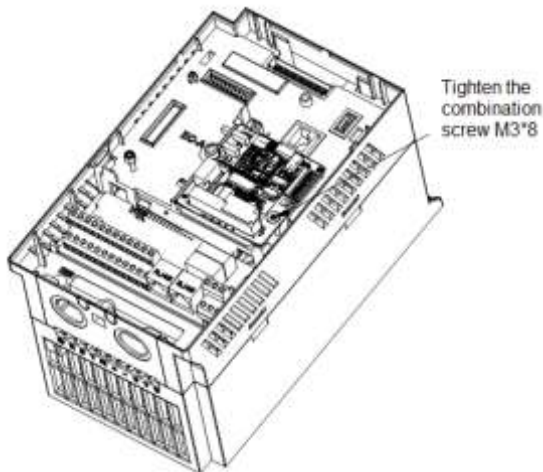
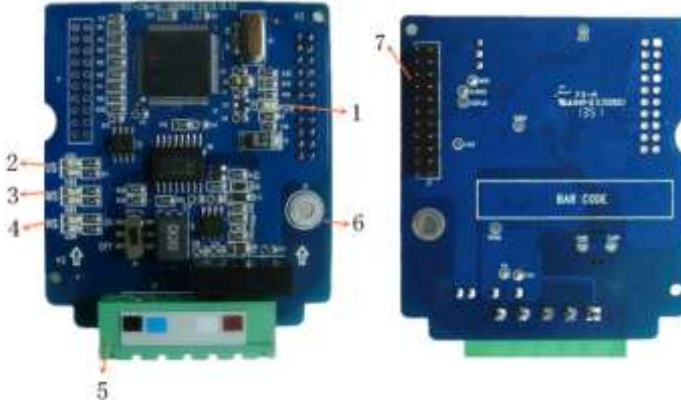

Figure 5 Installation of DeviceNet Expansion Card

Point DeviceNet expansion card at interface and location hole of expansion slot, and fix them with screws.

- **Figures of real objects are as follows:**



Elevation

Back Elevation

1. POWER Indicator 2. US Indicator 3. MS Indicator
 4. NS Indicator 5. DeviceNet Interface 6. Screw Location Hole 7. Inverter Interface

V.3 Expansion Terminal Function

Table 11 DeviceNet Expansion Card Terminal Function

Type	Item	Terminal	Description
DeviceNet Communication Terminal	Red	V+	DC24V
	White	CANH	Signal Line (Anode)
	-	S	Shielding Layer
	Blue	CANL	Signal Line (Cathode)
	Black	V-	Power Ground

Table 12 DeviceNet Expansion Card Indicators

Indicator	LED Status	Display	Solution
POWER	Off	No Power Supply	Check whether the power of communication card works normally
	On	Normal Power Supply	No need to do anything
NS	Off	No Power Supply	Check whether the power of communication card works normally
	Green Lamp	Communication Card	Configure communication card to

	Flicker	Already Connected Online, but Connection to Master Not Established	master scan list Re-download configuration data to master
	Green Lamp On	Communication Card Already Connected Online and Connection to Master Established	No need to do anything
	Red Lamp Flicker	Communication Card Already Connected Online and Single I/O Communication Overtime	Configure communication card to master scan list; Re-download the configuration data to master
	Red Lamp On	MACID Detection Failure; No Network Power Supply; Bus-off	Confirm that there is no repeated node address on the network Check if the network power supply is normal Confirm whether the communication rate and the wiring are normal
MS	Off	No Power Supply	Check whether the power of communication card works normally
	Green Lamp Flicker	Wait for I/O Data	Switch PLC to RUN status
	Green Lamp On	Normal I/O Data	No need to do anything
	Red Lamp Flicker	Mapping Error	Configure communication card or power on inverter again
	Red Lamp On	Hardware Error	Return for repairing
US	Off	No Power Supply	Check if the power of communication card works normally
	Green Lamp Flicker	Wait for Inverter to Return Data	Confirm that communication card and inverter are connected together normally
	Green Lamp On	Normal Data with Inverter	No need to do anything
	Red Lamp Flicker	Communication Overtime	Confirm that communication card and inverter are connected together normally
	Red Lamp On	Communication Failure	Power it on again

Table 13 DIP Switch of DeviceNet Expansion Card

Switch	Function
 S1	Select a matching end resistor

Appendix VI Air Compressor Expansion Card (EC-CM-D1)

VI.1 General

The EC-IO-K2 card is used for EM500 series inverter control terminal expansion, which contains the following resources:

Item	Specification	Description
Input	1 digital input	JT1 / JT2 fixed for emergency stop
	3 analog signal inputs	T1 + / T1- and T2 + / T2- can be connected to the PT100 for temperature detection P + / P- is a current signal of 0 ~ 20mA for air pressure detection
Output	2-way digital signal output	BJ1 / BJ2 fixed for alarm JZ1 / JZ2 fixed for loading valve control

VI.2 Installation Instructions

- Please install the IO expansion card in the EC-A expansion slot (note the installation is correct and snap in place).
- Please remove IO expansion card in case of inverter power is completely off.

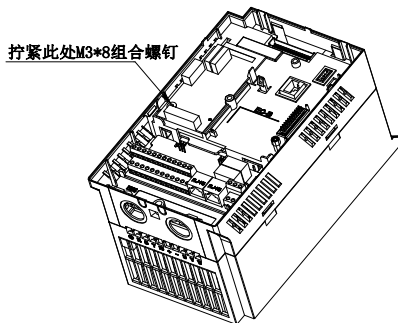
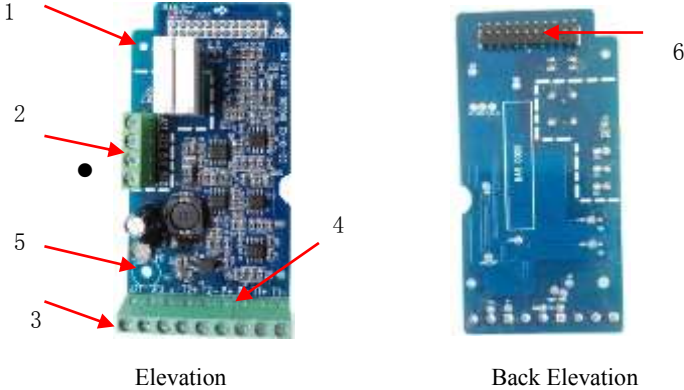

Figure 5 IO expansion card installation diagram

Align the I / O expansion card with the expansion slot interface and positioning holes, with screws.

- **Figures of real objects are as follows:**



1. Output relay 2. Relay output terminal 3. Digital signal input interface
 4. Analog input interface 5. Screw positioning hole 6. Inverter interface

VI.3 Expansion Terminal Function

Table 12 IO Expansion Card Terminal Function

Type	Terminal label	Terminal name	Terminal function description
Digital input	JT1	Emergency stop terminal	As the emergency stop switch is pressed it is open circuit, so inverter emergency stop effective as defaulted.
	JT2		
Digital output	BJ1	Alarm output terminal	Relay output terminal
	BJ2		
	JZ1	Load the output terminals	Relay output terminal
	JZ2		
Analog input	P+	Air pressure detection input	P + / P-, respectively, then positive and negative current-type pressure sensor two paragraphs, measuring range 0 ~ 20mA
	P-		
	T1+	Oil temperature detection	PT100 sensor input

	T1-	input	This input is used to check the oil temperature
	T2+	Motor temperature detection input	PT100 sensor input
	T2-		This input is used to check the motor temperature

Appendix VII Clock Expansion Card (EC-TM-A1)

VII.1 General

EC-TM-A1 card for EM500 series inverter control terminal expansion, which contains the following resources:

Item	Specification	Description
Clock chip	Clock chip	Provide accurate clock
Battery card slot	Clock chip backup battery slot	Only the CR2032 can be installed

VII.2 Installation Instructions

- Please install the IO expansion card in the EC-A expansion slot (note the installation is correct and snap in place).
- Please remove IO expansion card in case of inverter power is completely off

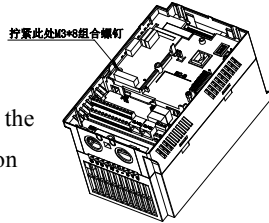
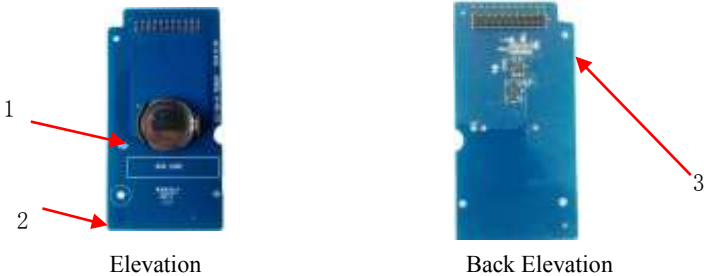

Figure 6 IO expansion card installation diagram

Align the I / O expansion card with the expansion slot interface and positioning holes, with screws.

Figures of real objects are as follows:



1. Battery card slot 2. screw positioning hole 3. Inverter interface

VII.3 Expansion Terminal Function

Table 13 IO Expansion Card Terminal Function

Type	Terminal label	Terminal name	Terminal function description
Battery card slot		Battery card slot	Please install the CR2032 battery. Only when the battery is installed, can the time continue after the drive is de-energized.

Appendix VIII Appendix VII. Phase Sequence

Expansion Card (EC-PSP-A1)

VIII.1 General

EC-PSPP-A1 card for EM500 series inverter control terminal expansion, which contains the following resources:

Item	Specification	Description
Input	3 analog voltage signal input	Support 380V input only, used to detect the phase angle of the grid and the actual output phase angle of the inverter phase angle difference
Output	2-way digital signal output	Used to control the frequency converter to the signal output

VIII.2 Installation Instructions

- Please install the IO expansion card in the EC-A expansion slot (note the installation is correct and snap in place).
- Please remove IO expansion card in case of inverter power is completely off

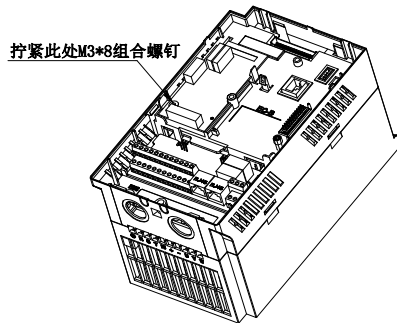
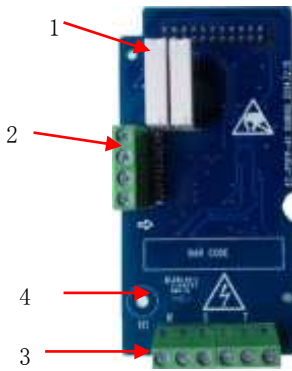

Figure 6 IO expansion card installation diagram

Align the I / O expansion card with the expansion slot interface and positioning holes, with screws.

Figures of real objects are as follows:



Elevation



Back Elevation

- 1. Output relay
- 2. Relay output terminal
- 3. Analog signal interface
- 4. Screw positioning hole
- 5. Inverter interface

VIII.3 Expansion Terminal Function

Table 14 IO Expansion Card Terminal Function

Type	Terminal label	Terminal name	Terminal function description
Digital signal output	RA3	R3 power frequency switching relay	Used to control the power grid to the motor's contactor
	RC3		
	RA4	R4 inverter startup is completed relay .	Used to control the inverter to the motor contactor
Digital signal input	R	Power detection circuit	Used to detect the phase sequence phase angle of the grid
	S		
	T		